

SW-101-N
Outdoor Waterproof
Digital Signage Player

User's Manual

Version 1.0
(August 2020)

Copyright

© 2020 IBASE Technology, Inc. All rights reserved.

No part of this publication may be reproduced, copied, stored in a retrieval system, translated into any language or transmitted in any form or by any means, electronic, mechanical, photocopying, or otherwise, without the prior written consent of IBASE Technology, Inc. (hereinafter referred to as “IBASE”).

Disclaimer

IBASE reserves the right to make changes and improvements to the products described in this document without prior notice. Every effort has been made to ensure the information in the document is correct; however, IBASE does not guarantee this document is error-free. IBASE assumes no liability for incidental or consequential damages arising from misapplication or inability to use the product or the information contained herein, nor for any infringements of rights of third parties, which may result from its use.

Trademarks

All the trademarks, registrations and brands mentioned herein are used for identification purposes only and may be trademarks and/or registered trademarks of their respective owners.

Compliance

CE

This product has passed CE Class B tests for environmental specifications and limits. This product is in accordance with the directives of the European Union (EU). In a domestic environment, this product may cause radio interference in which case users may be required to take adequate measures.

FCC

This product has been tested and found to comply with the limits for a Class B device, pursuant to Part 15 of the FCC Rules. These limits are designed to provide reasonable protection against harmful interference in a residential installation. This equipment generates, uses and can radiate radio frequency energy and, if not installed and used in accordance with manufacturer's instructions, may cause harmful interference to radio communications.

WEEE



This product must not be disposed of as normal household waste, in accordance with the EU directive of for waste electrical and electronic equipment (WEEE - 2012/19/EU). Instead, it should be disposed of by returning it to a municipal recycling collection point. Check local regulations for disposal of electronic products.

Green Bios



This product is compliant with the current RoHS restrictions and prohibits use of the following substances in concentrations exceeding 0.1% by weight (1000 ppm) except for cadmium, limited to 0.01% by weight (100 ppm).

- Lead (Pb)
- Mercury (Hg)
- Cadmium (Cd)
- Hexavalent chromium (Cr6+)
- Polybrominated biphenyls (PBB)
- Polybrominated diphenyl ether (PBDE)

Important Safety Information

Carefully read the precautions before using the device.

Environmental conditions:

- Slots and openings on the chassis are for ventilation. Make sure you leave plenty of space around the device for ventilation. Never allow objects of any kind to enter any openings in the system.
- Use this product in environments with ambient temperatures between -40°C and 75°C.
- Do not leave this device in an environment where the storage temperature may be below -20°C or above 80°C. This could damage the device. The device must be used in a controlled environment.

Care for your industrial products:

- Before cleaning the device, turn it off and unplug all external power sources.
- Use neutral cleaning agents or diluted alcohol to clean the device with a cloth; then wipe it with a dry cloth.
- Vacuum the dust with a computer vacuum cleaner to prevent the air vent or slots from being clogged.



WARNING

Attention during use:

- Do not use this product near water.
- Do not spill water or any other liquids on your device.
- Do not place heavy objects on the top of the device.
- Operate the device from the type of power source indicated on the marking label.
- Do not allow anything to rest on the power cord.
- If an extension cord is used, make sure that the total ampere rating of the product plugged into the extension cord does not exceed the extension cord ampere rating.

Avoid Disassembly

Do not disassemble, repair or make any modification to the device. Doing so could generate hazards and cause damage to the device, even bodily injury or property damage, and will void any warranty.



CAUTION

There is danger of explosion if internal lithium-ion battery is replaced by an incorrect type. Replace only with the same or equivalent type recommended by the manufacturer.

Warranty Policy

- **Industrial standard products:**

24-month (2-year) warranty from the date of shipment. If the date of shipment cannot be ascertained, the product serial numbers can be used to determine the approximate shipping date.
- **3rd-party parts:**

12-month (1-year) warranty from delivery for the 3rd-party parts that are not manufactured by us, such as CPU, CPU cooler, memory, storage devices, power adapter, panel and touchscreen.
- * PRODUCTS, HOWEVER, THAT FAIL DUE TO MISUSE, ACCIDENT, IMPROPER INSTALLATION OR UNAUTHORIZED REPAIR SHALL BE TREATED AS OUT OF WARRANTY AND CUSTOMERS SHALL BE BILLED FOR REPAIR AND SHIPPING CHARGES.

Technical Support & Services

1. Visit our website at www.ibt.ca to find the latest information about the product.
2. If you need any further assistance from your distributor or sales representative, prepare the following information of your product and elaborate upon the problem.
 - Product model name
 - Product serial number
 - Detailed description of the problem
 - The error messages in text or in screenshots if there is any
 - The arrangement of the peripherals
 - Software in use (such as OS and application software, including the version numbers)
3. If repair service is required, you can send a email to support@ibt.ca with the above informations or contact your distributor or sales representative.

Table of Contents

Chapter 1	General Information	1
1.1	Introduction	2
1.2	Features.....	2
1.3	Packing List	4
1.4	Optional Accessories	4
1.5	Specifications.....	7
1.6	Product View.....	9
1.7	Dimensions	10
Chapter 2	Hardware Installation & Motherboard Information	11
2.1	Installation / Replacement	12
2.1.1	Memory	12
2.1.2	Mini-PCIe Cards	13
2.1.3	WiFi / 3G / 4G Antenna Installation.....	13
2.1.4	Wall Mount Installation.....	14
2.2	Pinout for DC Power Input Connector	15
2.3	Pinout for Digital I/O Connector.....	16
2.4	Pinout for COM1 RS-232 Port.....	17
2.5	Pinout for LAN Port (M12).....	18
2.6	Pinout for USB Ports (M12).....	19
2.7	Setting the Jumpers	20
2.8	Jumper & Connector Locations on Motherboard	22
2.9	Jumpers Quick Reference.....	23
2.9.1	Clear CMOS Data (JP4).....	23
2.9.2	Clear ME Register (JP5)	24
2.10	Connectors Quick Reference	25
2.8.1	Board Input Power Connector (CN4)	25
2.8.2	5V Power Connector (J1)	26
2.8.3	RTC Battery Connector (J3)	26
2.8.4	Reset Connector (J8).....	26
2.8.5	Speaker Connector (J9, J10).....	27
2.8.6	COM RS-232 Connector (J11, J12).....	27
2.8.7	LAN Connector (J13).....	28
2.8.8	HDMI Connector (J14, J15)	28
2.8.9	Digital I/O Connector (J16)	29
2.8.10	System Fan Power Connector (SYS_FAN1).....	29

Chapter 3	Driver Installation	30
3.1	Introduction	31
3.2	Intel® Chipset Software Installation Utility	31
3.3	Graphics Driver Installation	33
3.4	HD Audio Driver Installation	34
3.5	LAN Driver Installation	35
3.6	Intel® Trusted Execution Engine Drivers Installation	36
Chapter 4	BIOS Setup	37
4.1	Introduction	38
4.2	BIOS Setup	38
4.3	Main Settings	39
4.4	Advanced Settings	40
4.4.1	ACPI Settings	41
4.4.2	iSmart Controller	42
4.4.3	Super IO Configuration	43
4.4.4	HW Monitor	46
4.4.5	CPU Configuration	47
4.4.6	PPM Configuration	47
4.4.7	IDE Configuration	48
4.4.8	USB Configuration	49
4.5	Chipset Settings	50
4.6	Security Settings	51
4.7	Boot Settings	52
4.8	Save & Exit Settings	53
Appendix	54
A.	I/O Port Address Map	55
B.	Interrupt Request Lines (IRQ)	57
C.	Watchdog Timer Configuration	58

Chapter 1

General Information

The information provided in this chapter includes:

- Product Features
- Packing List
- Optional Accessories
- Specifications
- Product View
- Dimensions

1.1 Introduction

The SW-101-N is a waterproof digital signage player designed for both indoor and harsh outdoor environments. This rugged fanless signage player is integrated with a 1.91GHz Intel® Atom™ Processor E3845 Quad-Core Processor and Intel® HD graphics (Gen 7-LP) 4EU.

The SW-101-N is built to withstand dust, water and extreme temperatures. It meets IP68 standards, allowing it to handle submersion in water for up to 30 minutes at a depth of 1.5 meters. The black-color waterproof enclosure utilizes a C3 HDMI connector and M12 I/O interface connectors for two USB 2.0, one Gigabit LAN, one RS232, DC power input, and digital I/O. Two antenna N jack type connectors have waterproof design as well. Aside from being fanless, the unit has a wide operating temperature range of -40°C ~ 75°C.

The SW-101-N supports unique iControl and Observer technologies for intelligent control and remote monitoring functions that feature auto power on/off scheduling, power resume, system temperature/voltage remote monitoring, and low temperature boot protection. The standard model has 4GB of DDR3L-1333 system memory, 64GB mSATA storage, and 12V DC-in support. Additional features include a watchdog timer, wall mount and Mini PCIe expansion for optional wireless modules.



1.2 Features

- iControl intelligent energy-saving & Observer remote monitoring technologies
- Waterproof, rugged, and fanless design with IP48 rating
- Intel® Atom™ E3845 Quad Core CPU
- 1 x DDR3L SO-DIMM 1333 MHz, expandable up to 8 GB, non-ECC
- Display output via M12 HDMI
- 2 x USB 2.0, 1 x RS-232, 1 x Digital I/O (all M12 connectors)
- 1 x Mini-PCIe slot for Wi-Fi or 3G/4G LTE options
- 1 x mSATA for storage
- -40°C ~ 75°C wide-range operating temperature

1.3 Packing List

Your product package should include the items listed below. If any of the items below is missing, contact the distributor or the dealer from whom you purchased the product.

- SW-101-N Digital Signage Player

1.4 Optional Accessories

We provides the following optional accessories:

- HDMI cable (with C3 rugged connector)
P/N: IP67-CAB-HDMI or C501HDMI140A12000P
One end of the cable is an M12 connector and the other end is an HDMI connector. Length is 180cm.

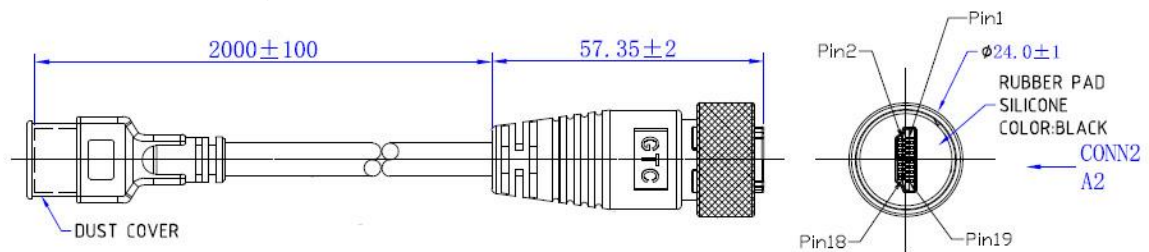

- Power cable (M12 female to 3-pin terminal connector)
P/N: IP67-CAB-PWRW or C501PW49800182000P
One end of the cable is an M12 connector and the other end is bare wire which is to be installed by the customer. Cable length is 180cm.

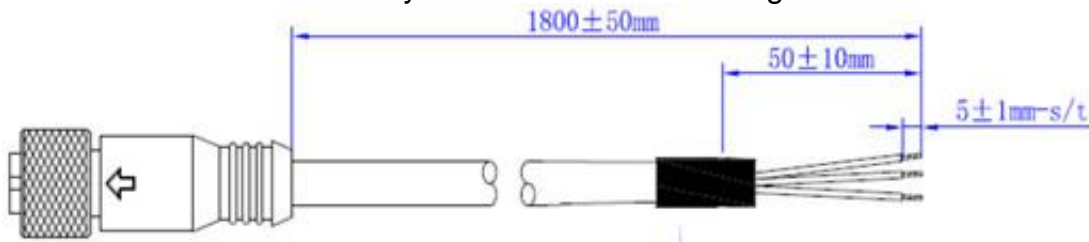

- PW518 Power Supply Cable

One end of the cable is an M12 connector and the other end a 4-pin Dinkle terminal block female plug (2EHDP-03P). Cable length is 180cm.
 P/N: IP67-CAB-PW518 or Y05PW5180A120000P

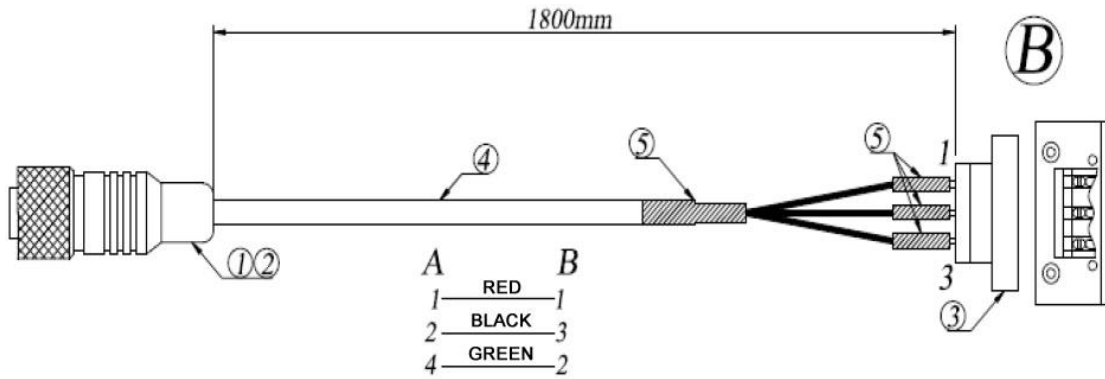

- LAN cable (M12 female to RJ45)

P/N: IP67-CAB-RJ45 or C501LAN6000A12000P

One end of the cable is an M12 connector and the other end is an RJ45 connector. Length is 180cm.

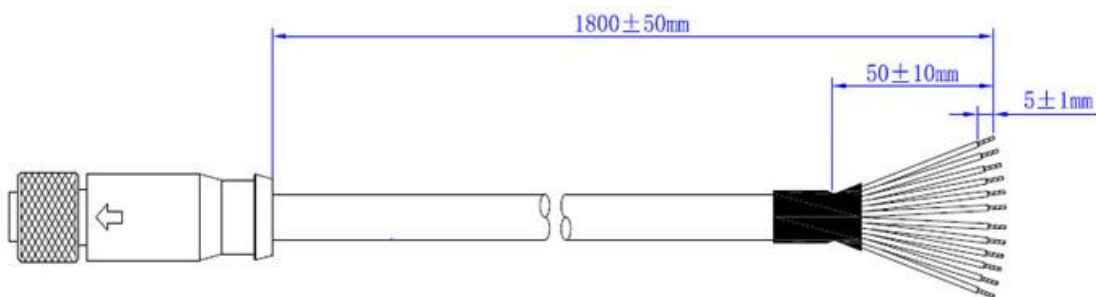

- USB 2.0 cable (M12 female to USB 2.0)

P/N: IP67-CAB-USB2F or C501USB1620A12000P

P/N: IP67-CAB-USB2M (male version of usb)

One end of the cable is an M12 connector and the other end is a USB connector. Length is 180cm.

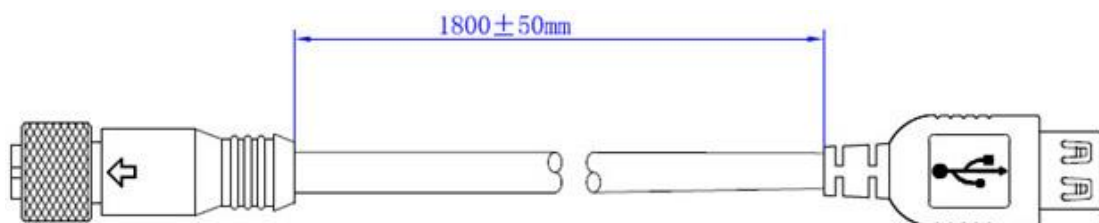

- Digital I/O cable (M12 female to open wire)

P/N : IP67-CAB-DIO or C501EXT6860A12000P

One end of the cable is an M12 connector and the other end is bare wire.
Length is 180cm.

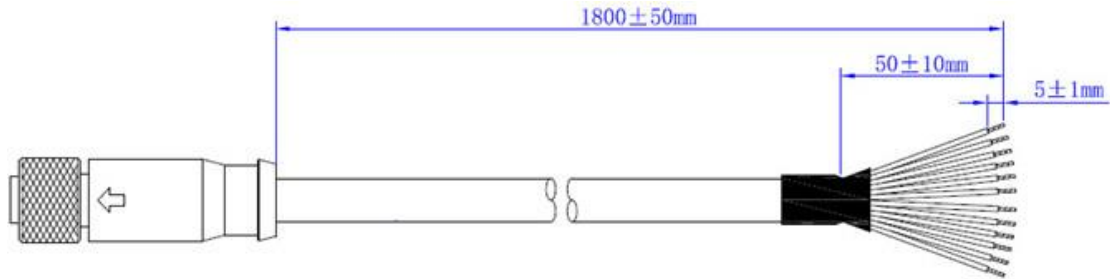

- Serial cable (M12 female to D-Sub9)

P/N: IP67-CAB-COM or C501EXT6850A12000P

One end of the cable is an M12 connector and the other end is a DB9 connector. Length is 180cm.

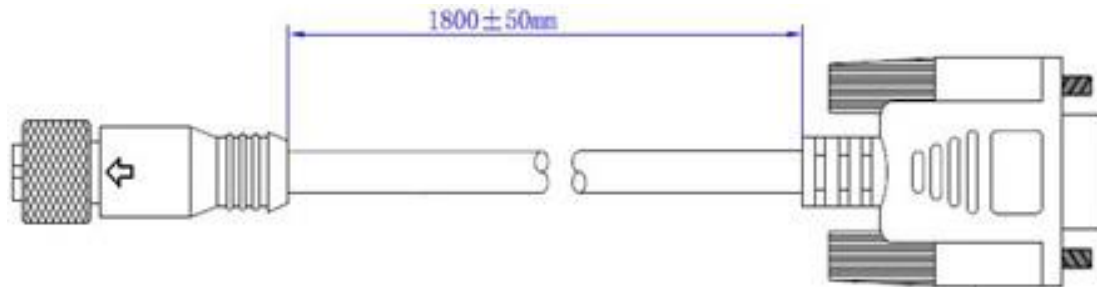

1.5 Specifications

Product	SW-101-N
Mainboard	SGT-MB3
Operating System	Windows 10 32-bit / 64-bit Enterprise Windows 8.1 / 8 Windows 7 32-bit / 64-bit WEC (Windows Embedded Compact) 2013 WEI (Windows Experience Index) 8.1
CPU	Intel® Atom™ E3845 Quad Core 1.91GHz, FCBGA1170
Chipset	SoC integrated
Memory	1 x DDR3L SO-DIMM 1333 MHz, expandable to 8 GB (Non-ECC)
Graphics	Intel® HD graphics Gen. 7-LP 4EU
LAN Controller	1 x Realtek RTL8111H GbE LAN Controller
Super I/O	Nuvoton NCT5523D
Storage	1 x mSATA slot
Power Requirement	DC-In 12V
Power Supply	84W power adapter (Optional)
Watchdog	Watchdog Timer 256 segments, 0, 1, 2...255 sec/min
Chassis	Aluminum die-casting and heavy-duty steel, black
Mounting	Wall mount
Dimensions (W x H x D)	227 x 70x 192 mm (8.93" x 2.75" x 7.55")
Net Weight	2.8 kg (6.17 lb)
Certificate	CE, FCC class B, CCC

I/O Ports	
Power	1 x DC-In power connector (M12 to 3-pin terminal block)
Display Interface	1 x HDMI (C3 connector)
LAN	1 x GbE LAN (M12 to RJ45)
Serial	1 x COM RS-232 (M12 to D-Sub9)
USB	2 x USB 2.0 (M12 connector)
Digital I/O	1 x 4-In/ 4-Out Digital I/O (M12 to open wire)
Antenna	2 x Antenna openings for jack type with waterproof design
Expansion	<ul style="list-style-type: none"> • 1 x Mini-PCle (half/full-size) for WiFi / 3G / 4G LTE options • 1 x Mini-PCle (half/full-size) for mSATA SSD
Environment	
Temperature	<ul style="list-style-type: none"> • Operating: -40 ~ 75 °C (-40 ~ 167 °F) • Storage: -20 ~ 80 °C (-4 ~ 176 °F)
Relative Humidity	10 ~ 90% at 45 °C (non-condensing)
Vibration Protection	mSATA: random operation 5 grms, 5~500 Hz

All specifications are subject to change without prior notice.

Note: The product performance relies on the system functioning as a whole. The level of CPU/APU/GPU processor, the interaction among the processor and the memory and storage bandwidth, or the functionality of the digital signage application software may affect the product performance.

1.6 Product View

Front View

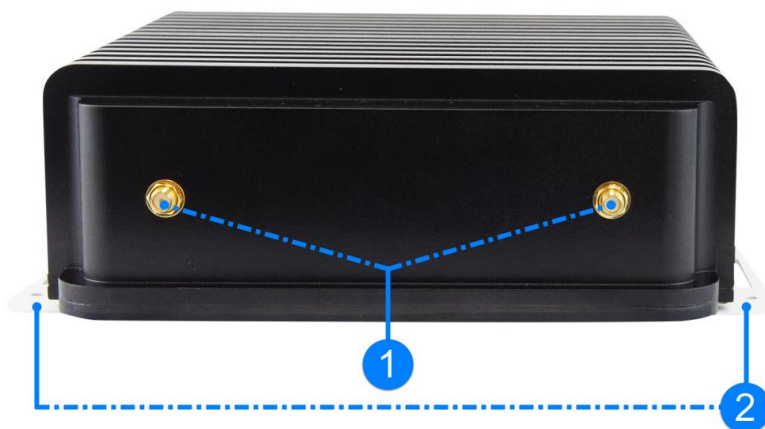

No.	Name	No.	Name
1	Antenna Holes	2	Wall Mount Kit

Rear View



No.	Name	No.	Name
1	HDMI Port (C3)	4	Digital I/O Port (M12 to open wire)
2	USB 2.0 Ports (M12)	5	GbE LAN Port (M12)
3	COM RS-232 Port (M12)	6	DC Power Input (M12 to 3-pin terminal block)

Oblique View



1.7 Dimensions

Unit: mm

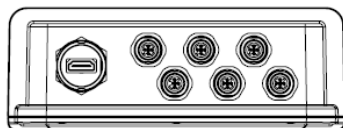
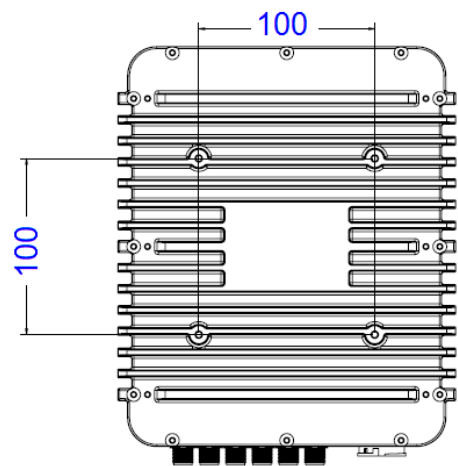
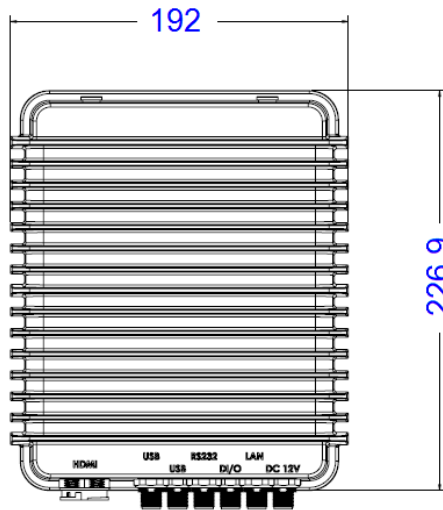

Chapter 2

Hardware Installation & Motherboard Information

The information provided in this chapter includes:

- Installation or replacement
- Information and locations of connectors

2.1 Installation / Replacement

Before doing any installation or any card/module replacement, loosen the 12 screws (show bellows) to remove the chassis bottom.

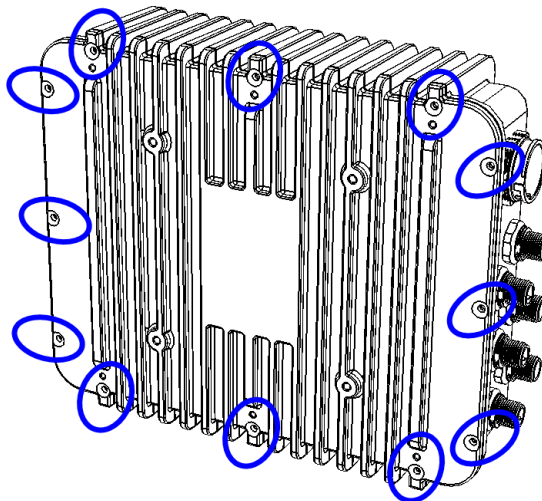

2.1.1 Memory

To install the modules, locate the memory slot on the motherboard and perform the following steps:

1. Press the ejector tab of the memory slot down and outwards with your fingertips.

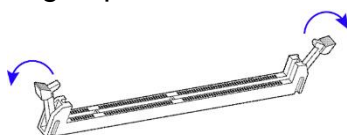

2. Hold the memory module and align the key of the module with that on the memory slot.
3. Gently push the module in an upright position until the ejector tabs of the memory slot close to hold the module in place when the module touches the bottom of the slot.

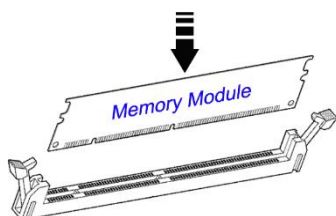

To remove the module, press the ejector tabs outwards with your fingertips to eject the module.

2.1.2 Mini-PCle Cards

1. Locate the mini-PCle or M.2 slot inside the device.
2. Align the key of the mini-PCle card to the mini-PCle interface, and insert the card slantwise. (Insert the M.2 card in the same way.)

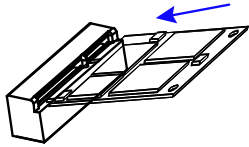

3. Push the mini-PCle card down and fix it with the an M2 screw. (Fix the M.2 network card with an M3 screw.)

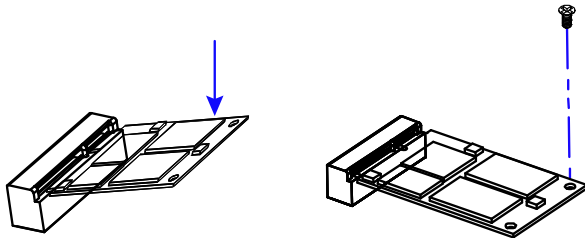

2.1.3 WiFi / 3G / 4G Antenna Installation

Thread the WiFi / 3G / 4G antenna extension cable through an antenna hole of the front I/O cover and fasten the antenna as shown below. Then apply adhesive to the edge of the hex nut behind the front I/O cover to prevent the extension cable from falling if the cable becomes loose.

1. Thread and fasten the hex nut and the washer. Then install the antenna.

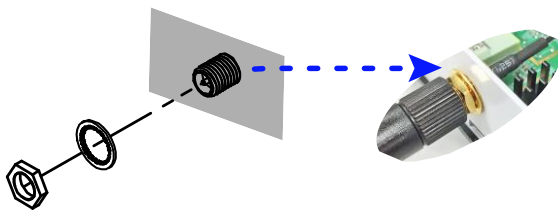

2. Apply adhesive around here.

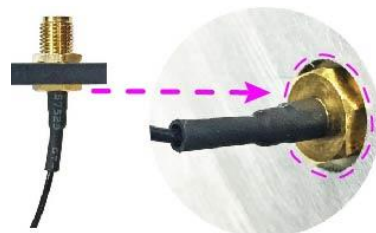

Info: The diameter of the nut is around 6.35 mm (0.25"-36UNC).

2.1.4 Wall Mount Installation

1. Turn the device upside down. Attach the wall-mount kit (2 brackets) to the device and secure it with the supplied 6 screws.

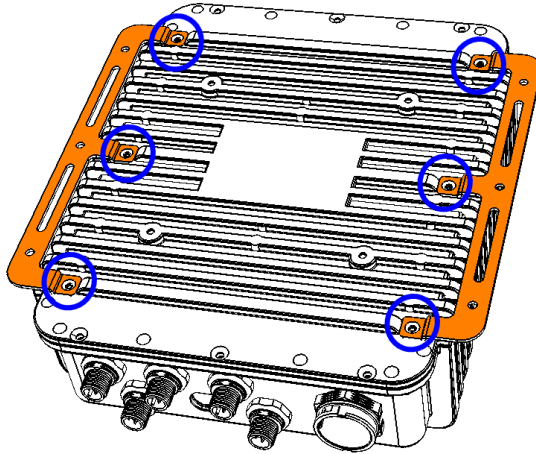

2. Prepare 4 screws (M3) to install the device on the wall, as shown.

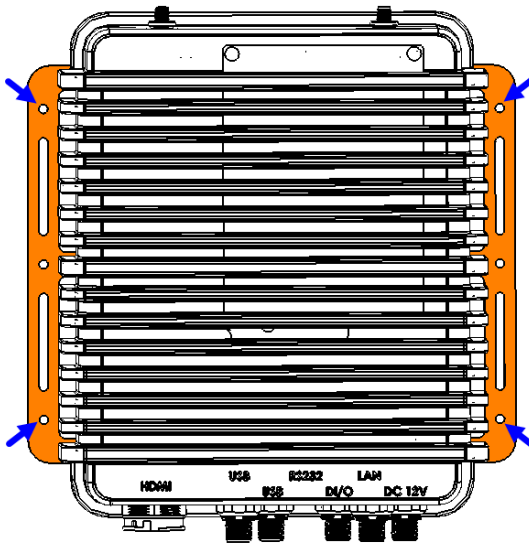

2.2 Pinout for DC Power Input Connector



DC Power Input Cable: M12 to 3-pin terminal block

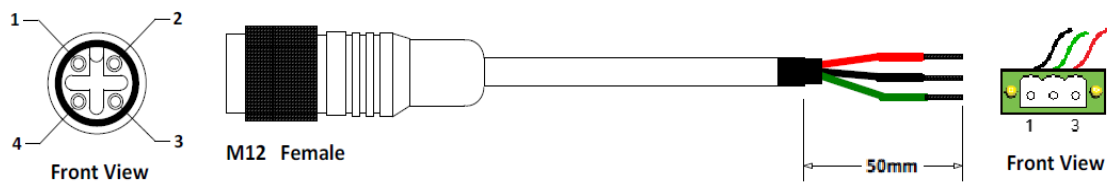

The DC power input cable is an optional accessory.

M12 end:

Pin	Signal Name	Pin	Signal Name
1	Voltage+	2	Voltage-
3	NC	4	Ground

Terminal block end:

Pin	Signal Name	Pin	Signal Name
1	Voltage- (Black)	2	Ground (Green)
3	Voltage+ (Red)		

2.3 Pinout for Digital I/O Connector



Digital I/O Cable: M12 to open wire

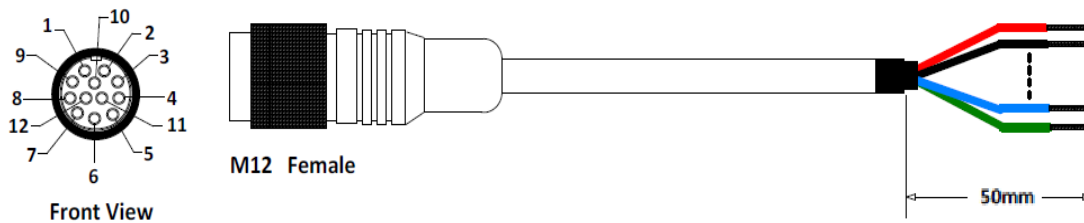

The Digital I/O cable is an optional accessory.

M12 end		Open Wire end
Pin	Signal Name	Pin
1	IN0	User-defined
2	Ground	
3	IN1	
4	Ground	
5	IN2	
6	Ground	
7	IN3	
8	Ground	
9	IN4	
10	Ground	
11	OUT1	
12	Ground	

2.4 Pinout for COM1 RS-232 Port



Serial Cable: M12 to D-Sub9

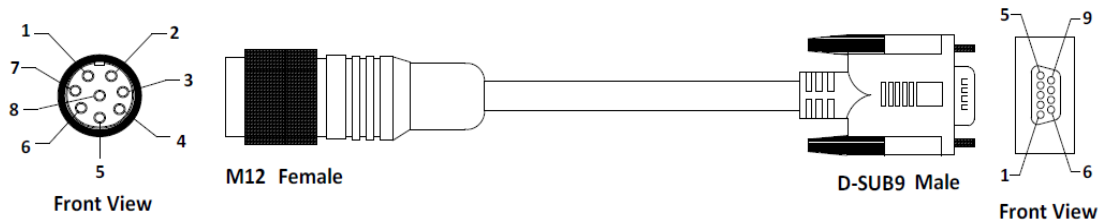

The serial cable is an optional accessory.

M12 end		D-Sub-end
Pin	Signal Name	Pin
1		1
2	RxD	2
3	TxD	3
4		4
5	Ground	5
6		6
7	RTS	7
8	CTS	8
9		9

2.5 Pinout for LAN Port (M12)

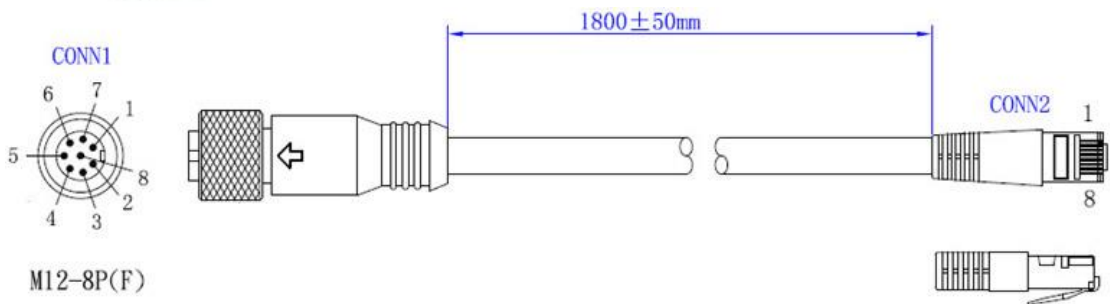

CONN1			CONN2
Pin		Color	Pin
1	Intertwined	White Orange	1
7		Orange	2
8	Intertwined	White Green	3
5		Green	6
3	Intertwined	Blue	4
2		White Blue	5
6	Intertwined	White Brown	7
4		Brown	8
Shell		Ground	Shell

2.6 Pinout for USB Ports (M12)



One end of the cable is an M12 connector and the other end is a USB connector. Length is 180cm.

Part Number: C501USB1620A12000P

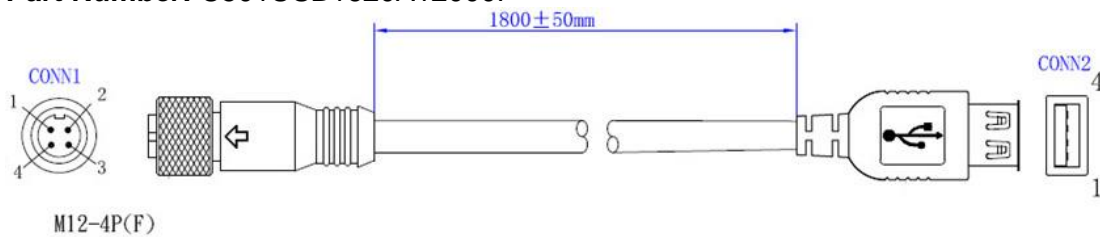

CONN1			CONN2
Pin		Color	Pin
1		Red	1
2	Intertwined	White	2
3		Green	3
4		Black	4
Shell		Ground	Shell

2.7 Setting the Jumpers

Set up and configure the SW-101-N with the jumpers on board according to your needs and applications. Contact your supplier if you have doubts about the best configuration for your use.

2.5.1 How to Set Jumpers

Jumpers are short-length conductors consisting of several metal pins with a non-conductive base mounted on the circuit board. Jumper caps are used to have the functions and features enabled or disabled. If a jumper has 3 pins, you can connect either PIN1 to PIN2 or PIN2 to PIN3 by shorting.

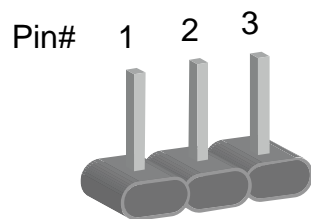

A 3-pin jumper

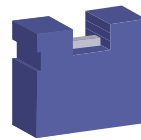

A jumper cap

Refer to the illustration below to set jumpers.

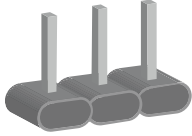
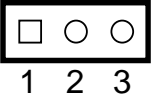
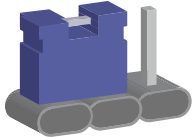
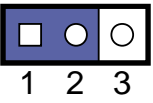
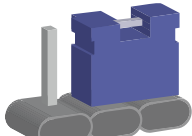
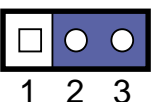
Pin closed	Oblique view	Illustration
Open		 1 2 3
1-2		 1 2 3
2-3		 1 2 3

When two pins of a jumper are encased in a jumper cap, this jumper is **closed**, i.e. turned **On**.

When a jumper cap is removed from two jumper pins, this jumper is **open**, i.e. turned **Off**.

2.9 Jumpers Quick Reference

Function	Connector	Page
Clearing CMOS Data	JP4	23
Clearing ME Register	JP5	24
Factory Use Only	JP1, JP2, JP3	--

2.9.1 Clear CMOS Data (JP4)

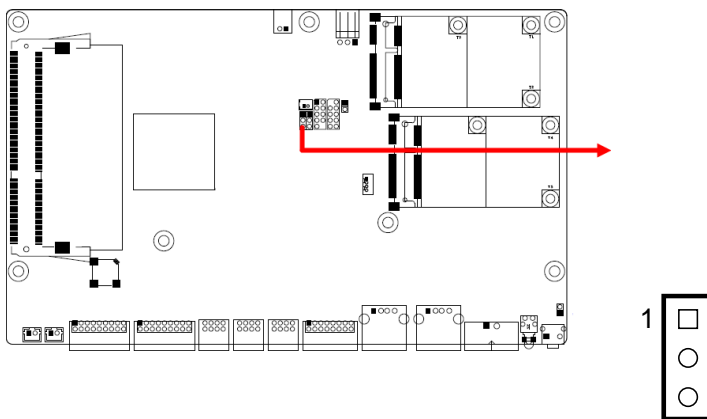

Function	Pin closed	Illustration
Normal (default)	1-2	1
Clear CMOS	2-3	1

2.9.2 Clear ME Register (JP5)

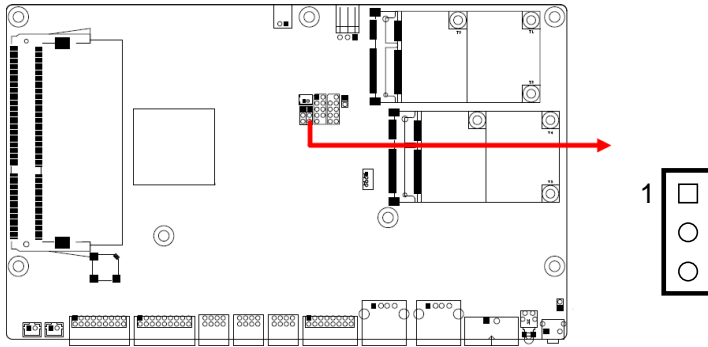

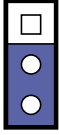
Function	Pin closed	Illustration
Normal (default)	1-2	1 
Clear ME	2-3	1 

2.10 Connectors Quick Reference

Function	Connector Name	Page
Board Input Power Connector	CN4	24
5V Power Connector	J1	25
RTC Battery Connector	J3	25
Reset Connector	J8	25
Speaker Connector	J9 (left), J10 (right)	26
COM RS-232 Connector	J11, J12	26
LAN Connector	J13	28
HDMI Connector	J14, J15	28
Digital I/O Connector	J16	28
System Fan Power Connector	SYS_FAN1	28
Power Button	SW1	--
Power LED Indicator	LED1	--
USB 2.0 Connector	CN2, CN3	--
Mini-PCIe Slot	J2 (wireless), J5 (for mSATA)	--
DDR3L Memory Slot	J4	--
Factory Use Only	J17	--

2.8.1 Board Input Power Connector (CN4)

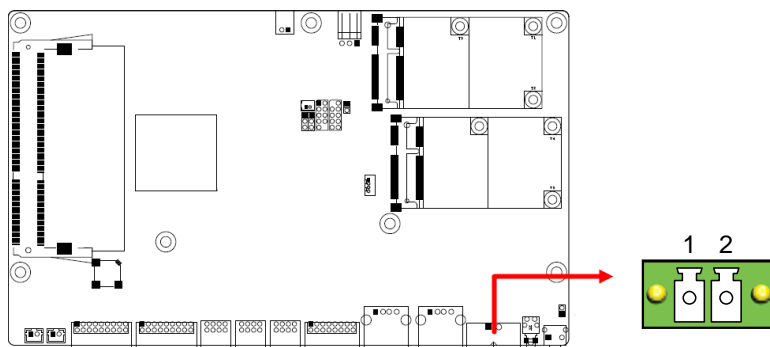

Pin	Signal Name	Pin	Signal Name
1	12V	2	Ground

2.8.2 5V Power Connector (J1)

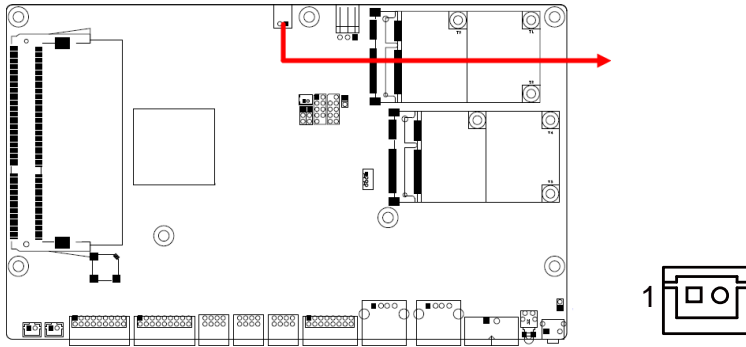

Pin	Signal Name	Pin	Signal Name
1	5V	2	Ground

2.8.3 RTC Battery Connector (J3)

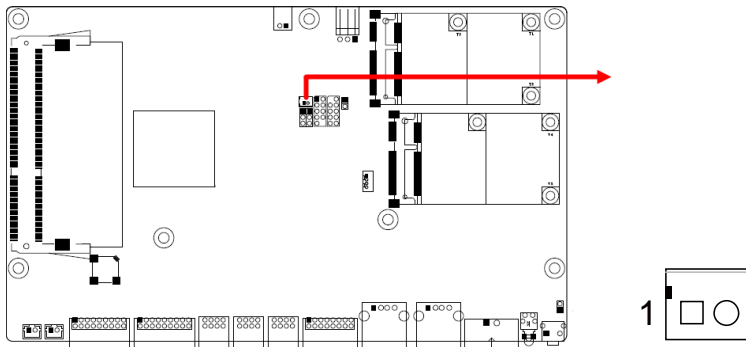

Pin	Signal Name	Pin	Signal Name
1	Battery+	2	Ground

2.8.4 Reset Connector (J8)

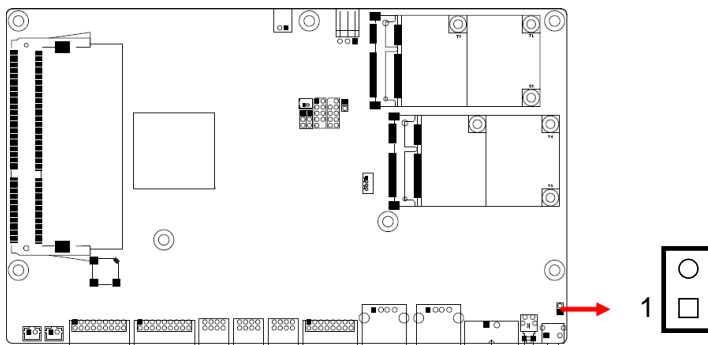

Pin	Signal Name	Pin	Signal Name
1	Reset	2	Ground

2.8.5 Speaker Connector (J9, J10)

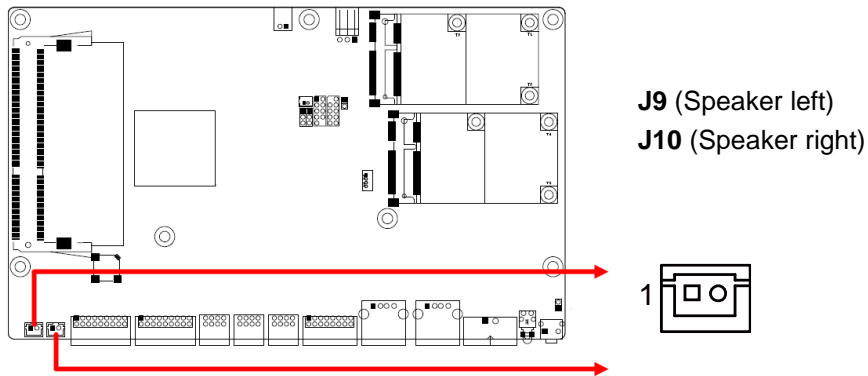

J9: Speaker left

Pin	Signal Name	Pin	Signal Name
1	SPK-L+	2	SPK-L-

J10: Speaker right

Pin	Signal Name	Pin	Signal Name
1	SPK-R+	2	SPK-R-

2.8.6 COM RS-232 Connector (J11, J12)

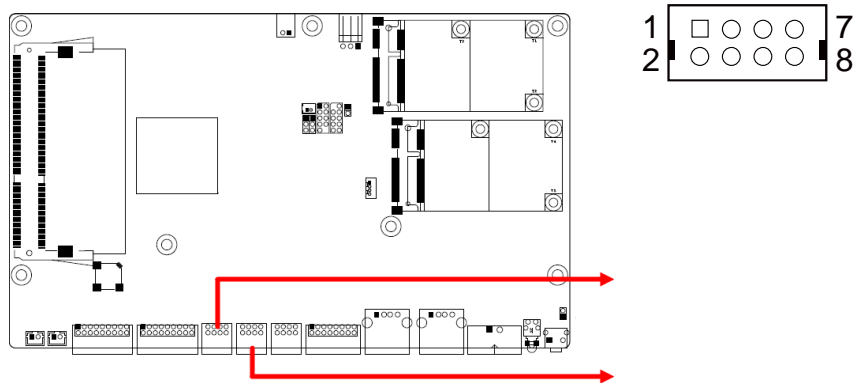

Pin	Signal Name	Pin	Signal Name
1	SIN	2	SOUT
3	Ground	4	NC
5	RTS	6	CTS
7	NC	8	NC

2.8.7 LAN Connector (J13)

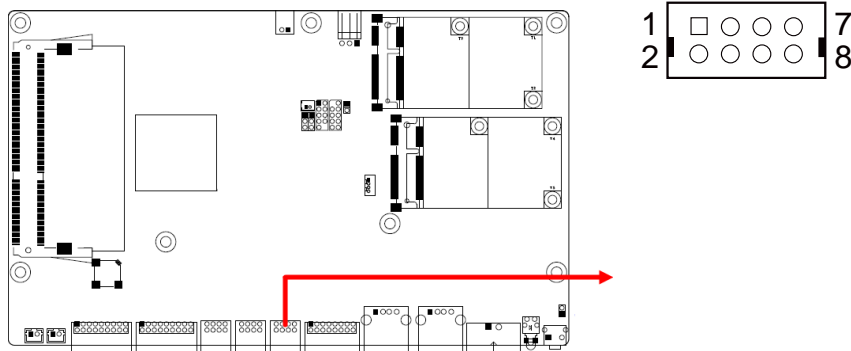

Pin	Signal Name	Pin	Signal Name
1	MDI3+	2	MDI3-
3	MDI2+	4	MDI2-
5	MDI1+	6	MDI1-
7	MDI0+	8	MDI0-

2.8.8 HDMI Connector (J14, J15)

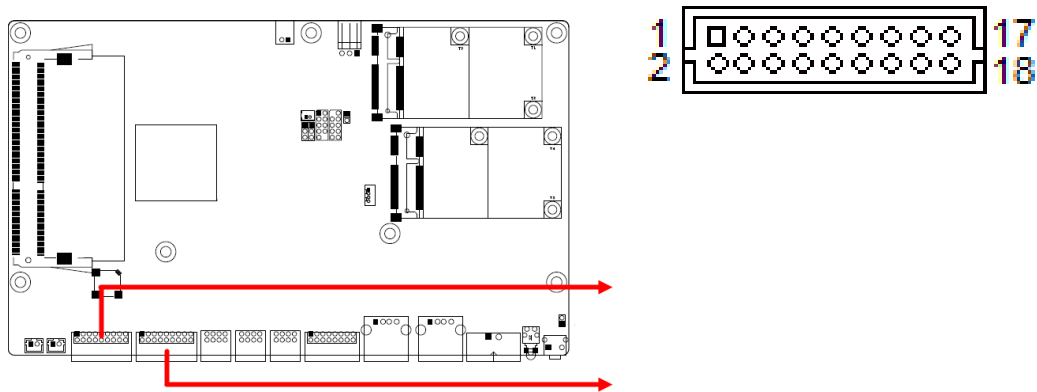

Pin	Signal Name	Pin	Signal Name
1	TMDS_DATA2_P	2	TMDS_DATA2_N
3	Ground	4	Ground
5	TMDS_DATA1_P	6	TMDS_DATA1_N
7	Ground	8	Ground
9	TMDS_DATA0_P	10	TMDS_DATA0_N
11	Ground	12	Ground
13	TMDS_CLK_P	14	TMDS_CLK_N
15	Ground	16	Ground
17	+5V_CON_R	18	HPD_ESD
19	TMDS_SCL_SINK	20	TMDS_SDA_SINK

2.8.9 Digital I/O Connector (J16)

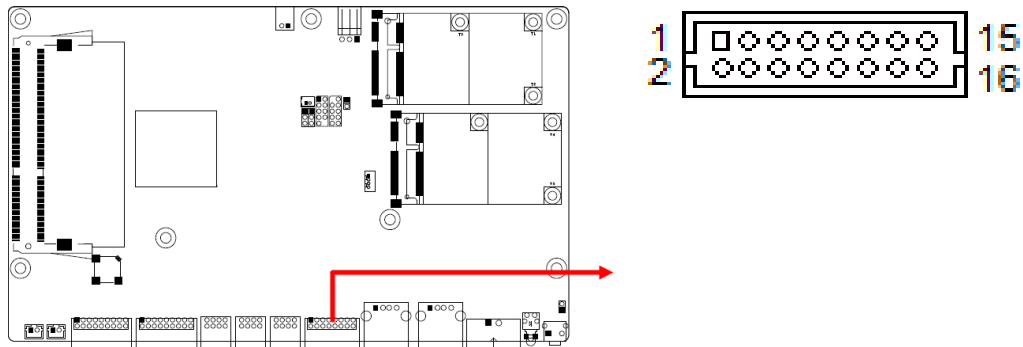

Pin	Signal Name	Pin	Signal Name
1	IN0	2	Ground
3	IN1	4	Ground
5	IN2	6	Ground
7	IN3	8	Ground
9	IN4	10	Ground
11	IN5	12	Ground
13	IN6	14	Ground
15	OUT1	16	Ground

2.8.10 System Fan Power Connector (SYS_FAN1)

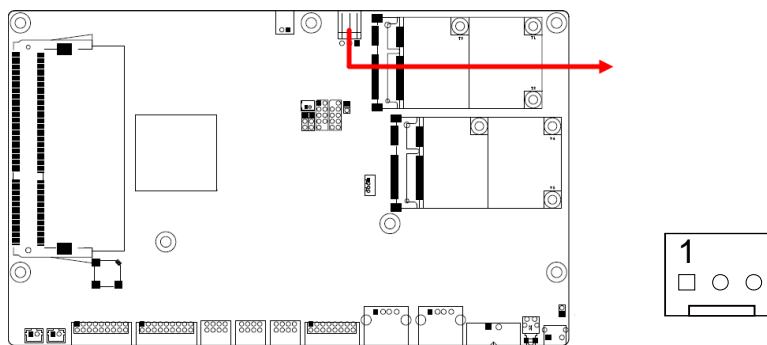

Pin	Signal Name	Pin	Signal Name
1	Ground	3	N/A
2	+12V		

Chapter 3

Driver Installation

The information provided in this chapter includes:

- Intel® Chipset Software Installation Utility
- Graphics Driver
- HD Audio Driver
- Intel® Trusted Execution Engine
- LAN Driver

3.1 Introduction

This section describes the installation procedures for software drivers. The software drivers are available on website. Go to the support or download page of the product.

Note: After installing your Windows operating system, you must install the Intel® Chipset Software Installation Utility first before proceeding with the drivers installation.

3.2 Intel® Chipset Software Installation Utility

The Intel® Chipset drivers should be installed first before the software drivers to install INF files for Plug & Play function for the chipset components. Follow the instructions below to complete the installation.

1. Run the **Setup.exe** file.
2. When the *Welcome* screen to the Intel® Chipset Device Software appears, click **Next** to continue.

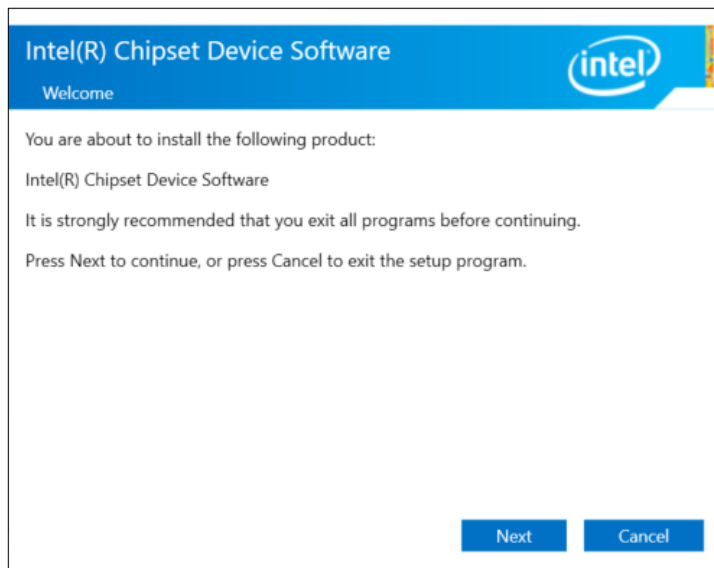

3. Accept the license agreement and proceed with the installation process.

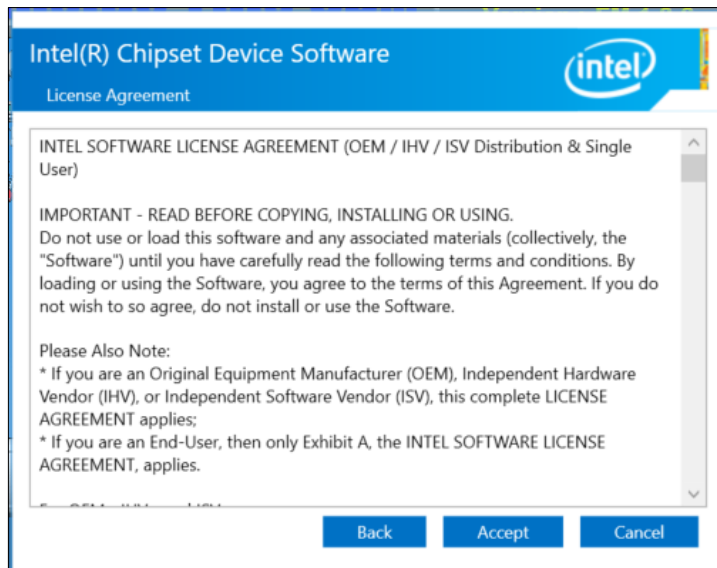

4. Click **Install**.

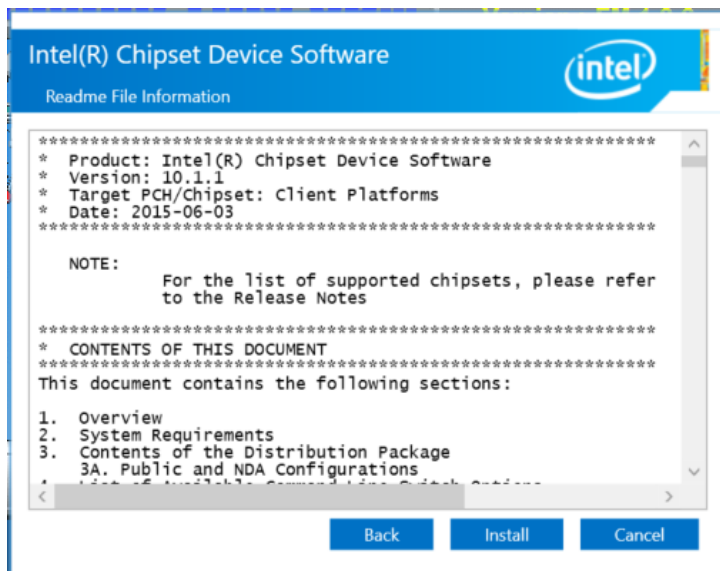

5. When the driver is completely installed, restart the computer for changes to take effect.

3.3 Graphics Driver Installation

1. Run the **Setup.exe** file.
2. On the *Welcome* screen, click **Next**.

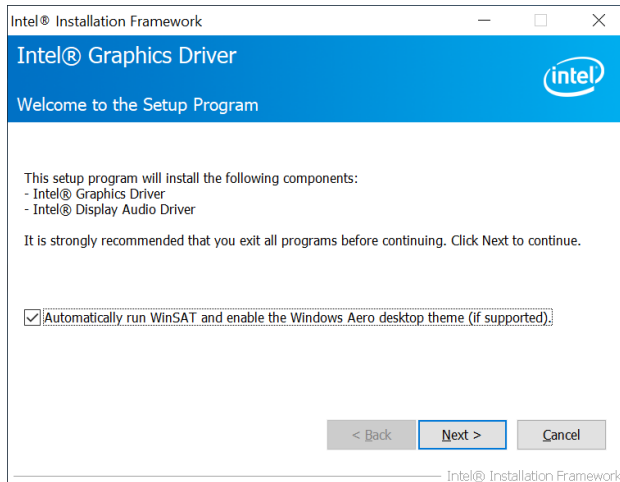

3. Accept the license agreement and click **Yes** to continue.

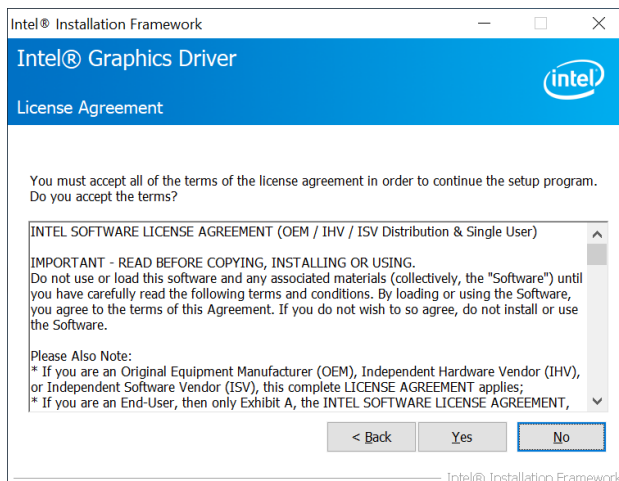

4. On the *Readme File Information*, click **Next**.

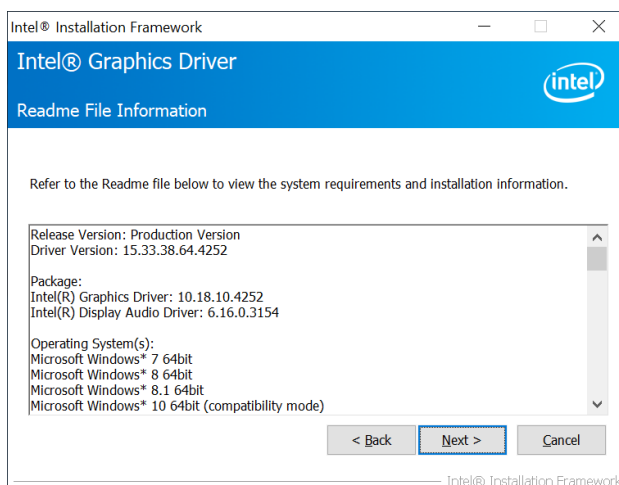

3.5 LAN Driver Installation

1. Run the **Setup.exe** file.
2. On the *Welcome* screen of the InstallShield Wizard, click **Next**.

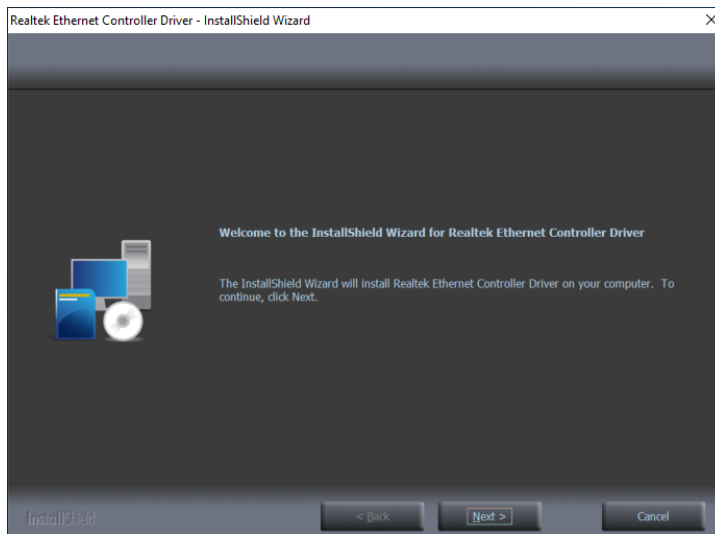

3. Click **Install**.

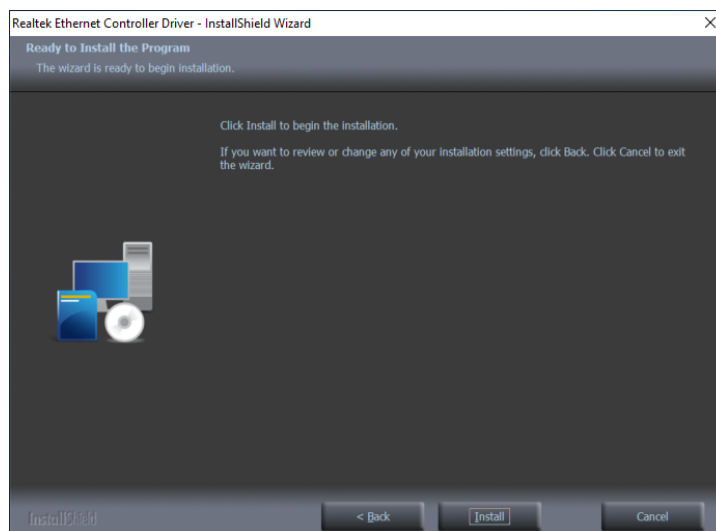

4. When the driver is completely installed, restart the computer for changes to take effect.

3.6 Intel® Trusted Execution Engine Drivers Installation

1. Run the **Setup.exe** file.
2. When the *Welcome* screen appears, click **Next**.

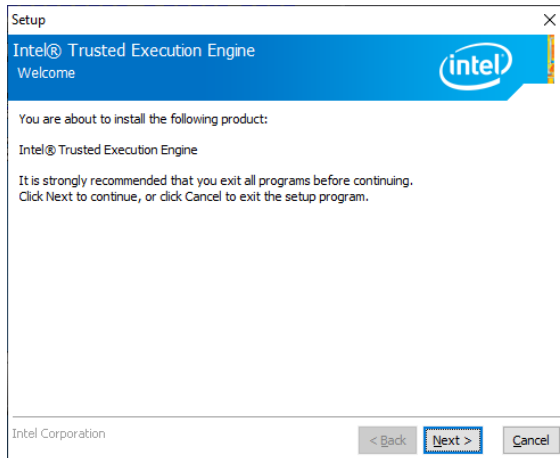

3. Accept the license agreement and click **Next** for installation.

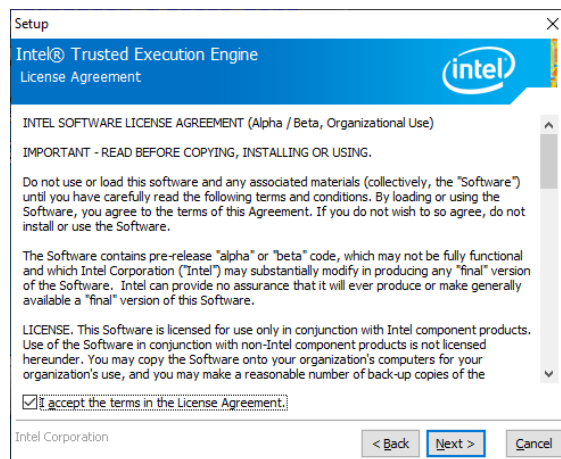

4. Click **Next** until the installation starts.

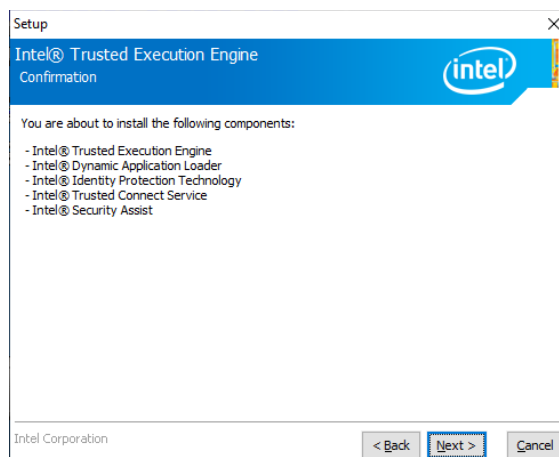

5. As the driver has been completely installed, restart the computer for changes to take effect.

Chapter 4

BIOS Setup

This chapter describes the different settings available in the AMI BIOS that comes with the board. The topics covered in this chapter are as follows:

- Main Settings
- Advanced Settings
- Chipset Settings
- Security Settings
- Boot Settings
- Save & Exit

4.1 Introduction

The BIOS (Basic Input/Output System) installed in the ROM of your computer system supports Intel® processors. The BIOS provides critical low-level support for standard devices such as disk drives, serial ports and parallel ports. It also provides password protection as well as special support for detailed fine-tuning of the chipset controlling the entire system.

4.2 BIOS Setup

The BIOS provides a Setup utility program for specifying the system configurations and settings. The BIOS ROM of the system stores the Setup utility. When you turn on the computer, the BIOS is immediately activated. Press the key immediately allows you to enter the Setup utility. If you are a little bit late pressing the key, POST (Power On-Self-Test) will continue with its test routines, thus preventing you from invoking the Setup. You can also press <F7> to call the pop-up Boot menu immediately.

If you still need to enter Setup, restart the system by pressing the "Reset" button or simultaneously pressing the <Ctrl>, <Alt> and <Delete> keys. You can also restart by turning the system Off and back On again.

The following message will appear on the screen:

```
Press <DEL> to Enter Setup
```

In general, press the arrow keys to highlight items, <Enter> to select, the <PgUp> and <PgDn> keys to change entries, <F1> for help, and <Esc> to quit.

When you enter the BIOS Setup utility, the *Main Menu* screen will appear on the screen. The Main Menu allows you to select from various setup functions and exit choices.

Warning: It is strongly recommended that you avoid making any changes to the chipset defaults.

These defaults have been carefully chosen by both AMI and your system manufacturer to provide the absolute maximum performance and reliability. Changing the defaults could make the system unstable and crash in some cases.

4.3 Main Settings

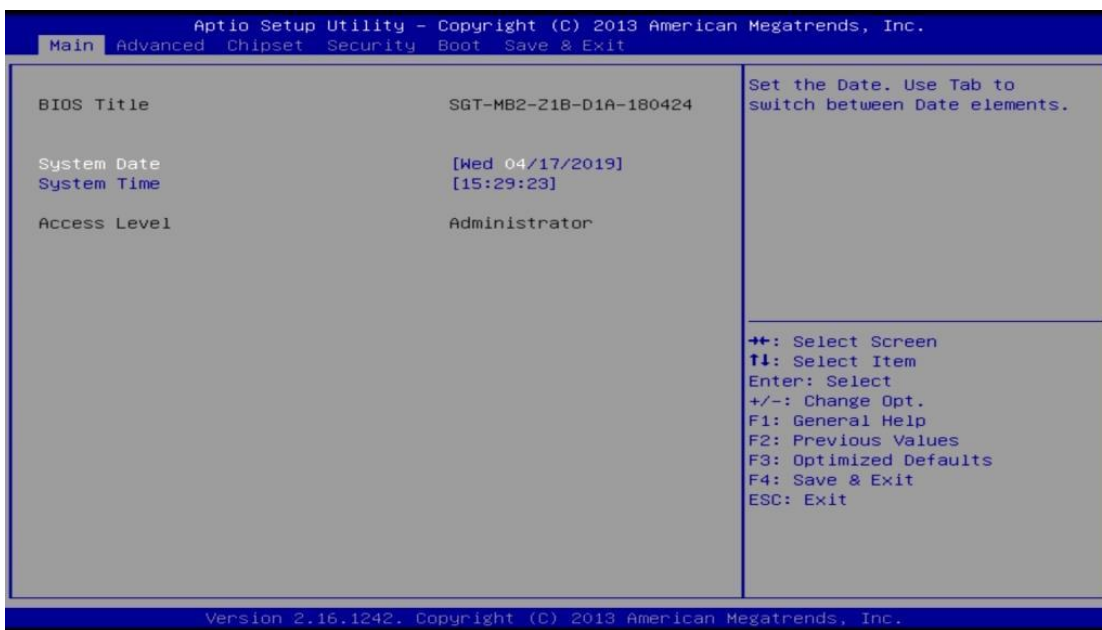

BIOS Setting	Description
System Date	Sets the date. Use the <Tab> key to switch between the date elements.
System Time	Set the time. Use the <Tab> key to switch between the time elements.

4.4 Advanced Settings

This section allows you to configure, improve your system and allows you to set up some system features according to your preference.

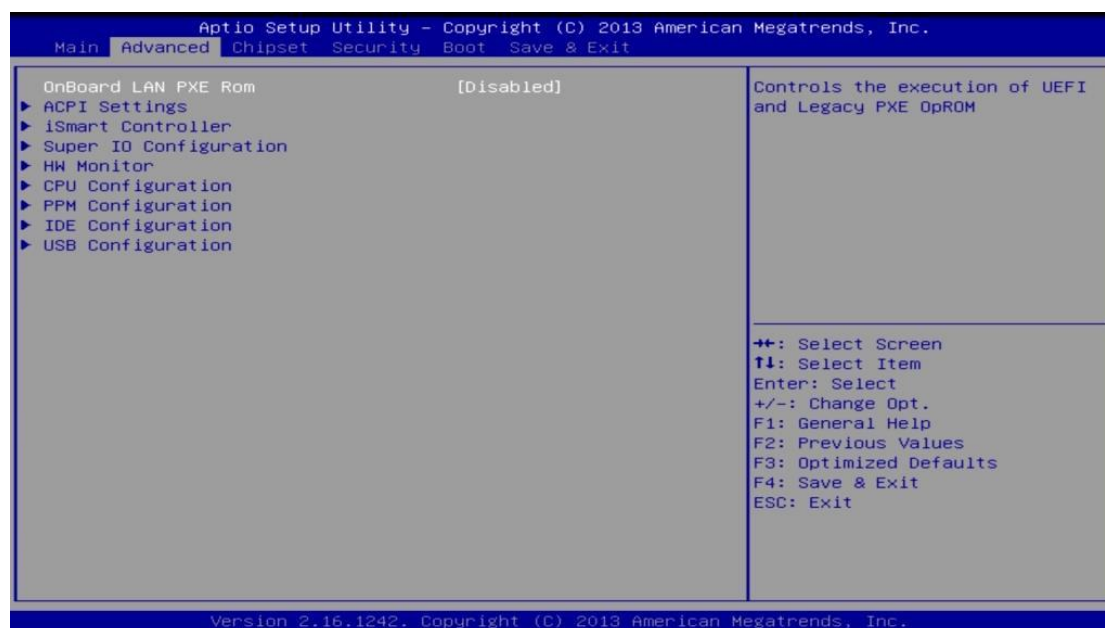

BIOS Setting	Description
OnBoard LAN PXE Rom	Controls the execution of UEFI and Legacy PXE OpROM.
ACPI Settings	Displays the system ACPI parameters..
iSmart Controller	Sets up the power on time for the system.
Super IO Configuration	Displays the parameters of the system Super I/O chip.
HW Monitor	Shows the monitor hardware status.
CPU Configuration	Presents the parameters of the CPU configuration.
PPM Configuration	Shows the parameters of PPM configuration.
IDE Configuration	Configures the IDE devices.
USB Configuration	Shows the parameters of USB configuration.

4.4.1 ACPI Settings

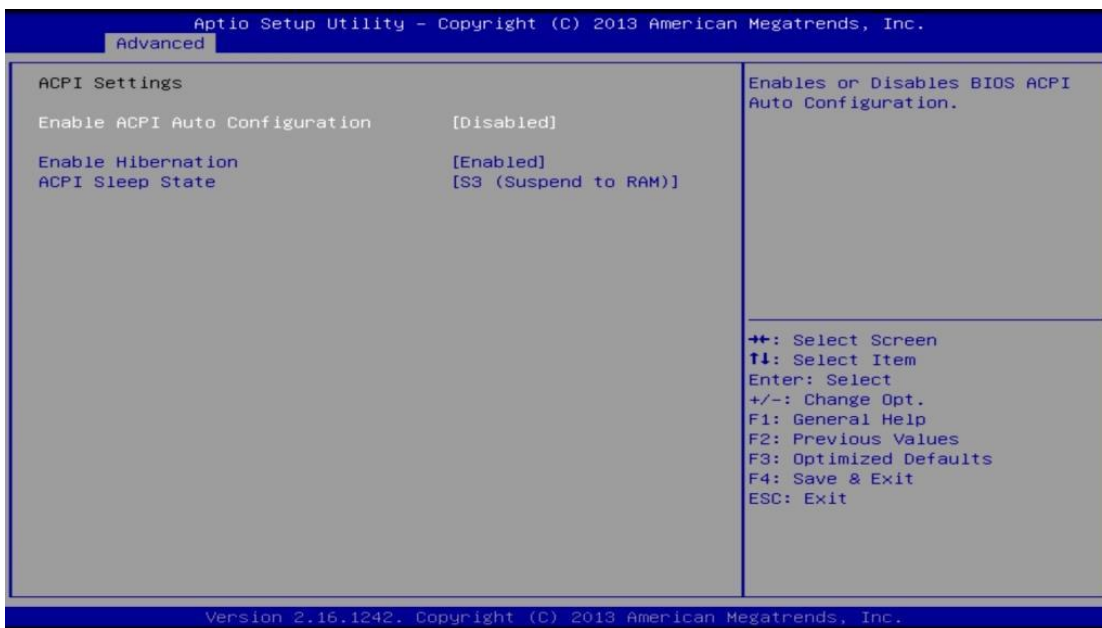

BIOS Setting	Description
Enable ACPI Auto Configuration	Enables / Disables BIOS ACPI Auto configuration.
Enable Hibernation	Enables / Disables system ability to hibernate (OS/S4 Sleep State). This option may not be effective with some operating systems.
ACPI Sleep State	Selects the highest ACPI sleep state the system will enter when the SUSPEND button is pressed.

4.4.2 iSmart Controller

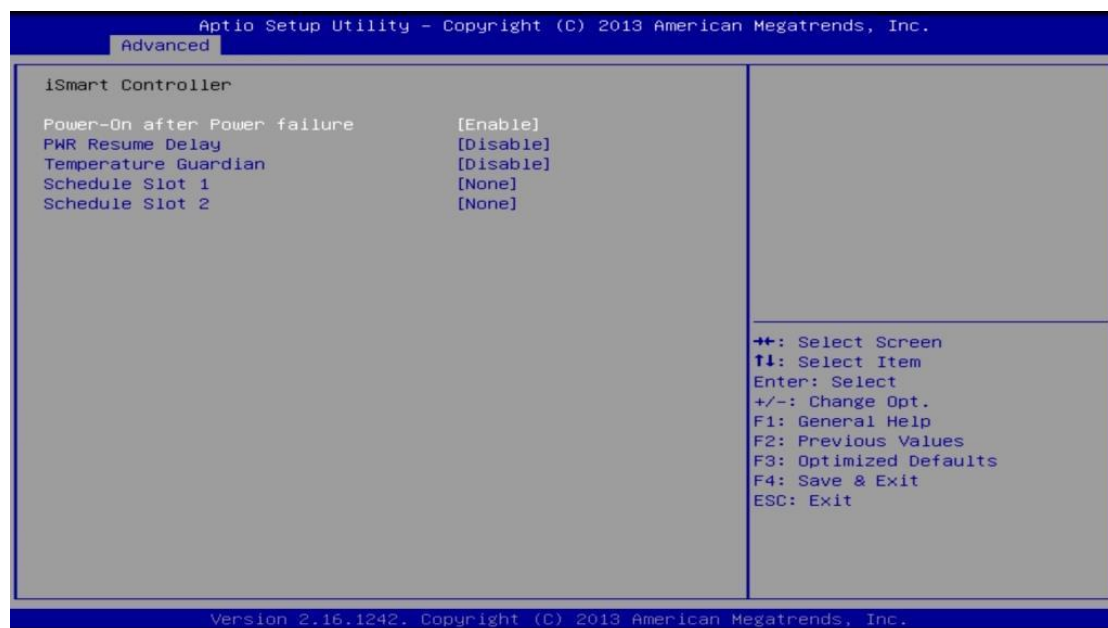

BIOS Setting	Description
Power-On after Power failure	Enables / Disables the system to be turned on automatically after a power failure.
PWR Resume Delay	Enables / Disables power on resume delay.
Temperature Guardian	Generates the reset signal when system hands up on POST.
Schedule Slot 1 / 2	<p>Sets up the hour / minute for system powe-on.</p> <p>Important: If you would like to set up a schedule between adjacent days, configure two schedule slots.</p> <p>For example, if setting up a schedule from Wednesday 5 p.m. to Thursday 2 a.m., configure two schedule slots. But if setting up a schedule from 3 p.m to 5 p.m. on Wednesday, configure only a schedule slot.</p>

4.4.3 Super IO Configuration

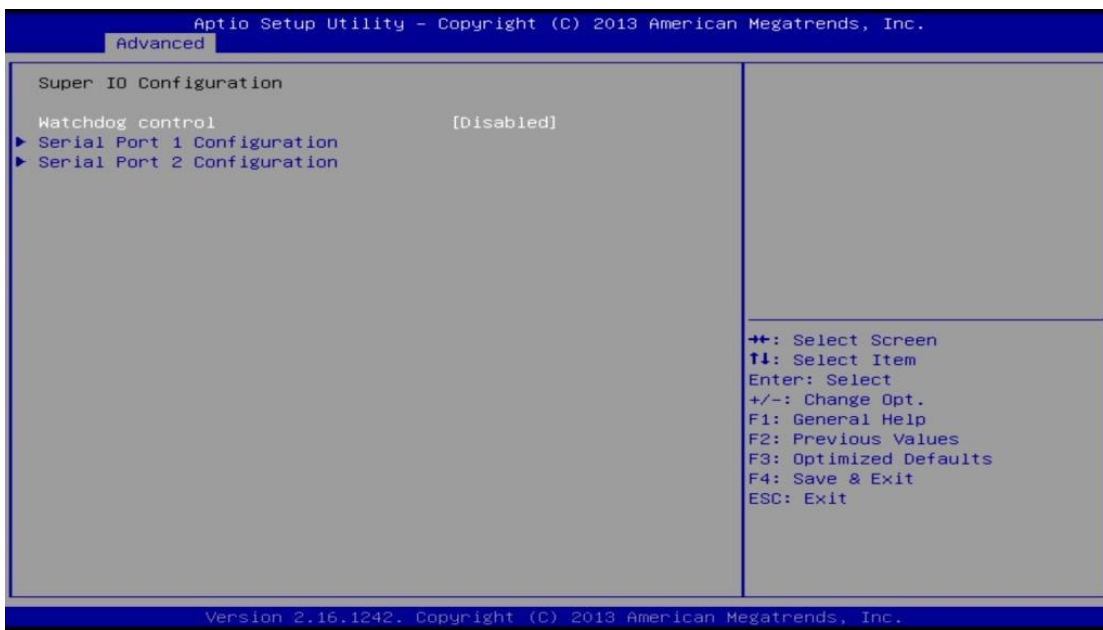

BIOS Setting	Description
Watchdog Control	Controls the Watchdog. Options: Disabled, 30 sec, 60 sec, 90 sec, 120 sec
Serial Port 1 & 2 Configuration	Sets parameters of Serial Port 1 & 2 (COMA & COMB). Enables / Disables the serial port and select an optimal setting for the Super IO device.

4.4.3.1. Serial Port 1 Configuration

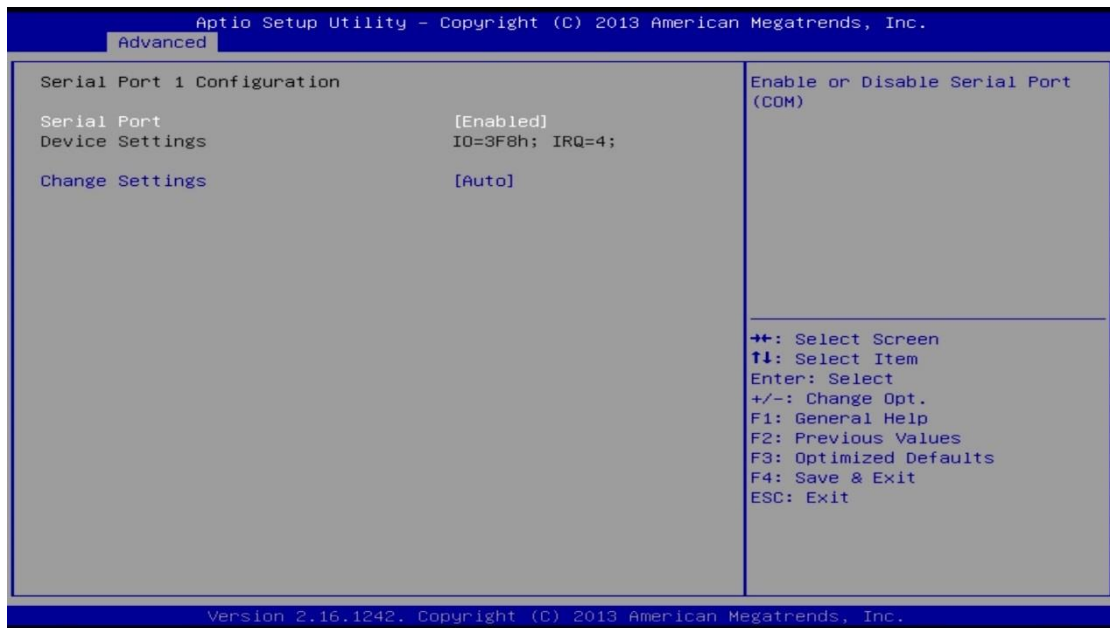

BIOS Setting	Description
Serial Port	Enables / Disables serial port (COM).
Change Settings	<p>Selects an optimal settings for Super I/O device.</p> <p>Options:</p> <ul style="list-style-type: none"> • Auto • IO = 3F8h; IRQ = 4 • IO = 3F8h; IRQ = 3, 4, 5, 6, 7, 9, 10, 11, 12 • IO = 2F8h; IRQ = 3, 4, 5, 6, 7, 9, 10, 11, 12 • IO = 3E8h; IRQ = 3, 4, 5, 6, 7, 9, 10, 11, 12 • IO = 2E8h; IRQ = 3, 4, 5, 6, 7, 9, 10, 11, 12

4.4.3.2. Serial Port 2 Configuration

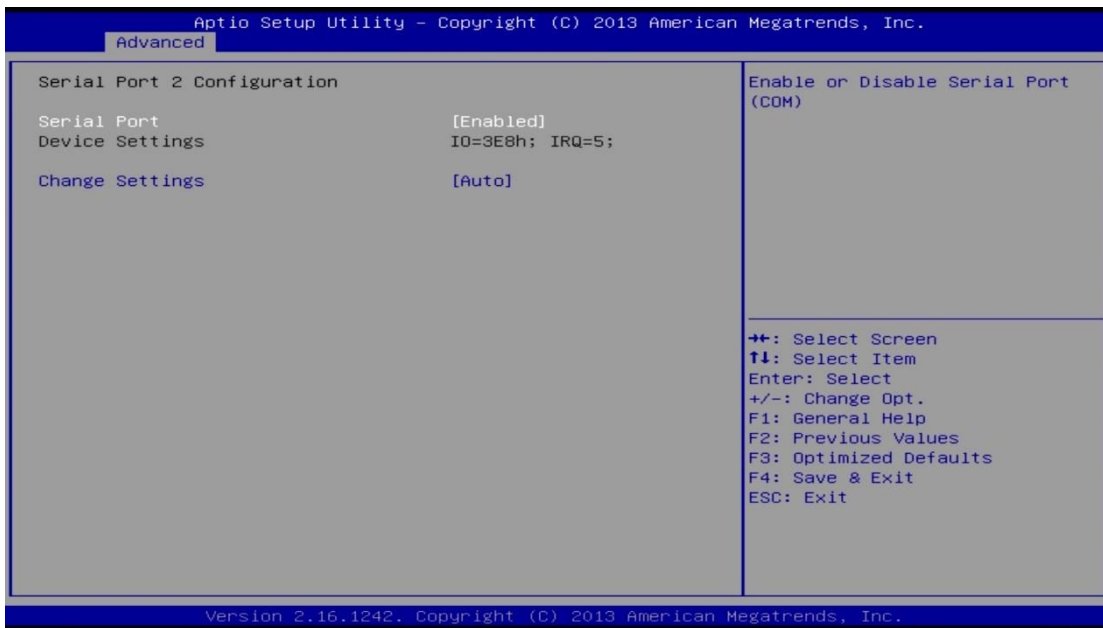

BIOS Setting	Description
Serial Port	Enables / Disables serial port (COM).
Change Settings	Selects an optimal settings for Super I/O device. Options: <ul style="list-style-type: none"> • Auto • IO = 3E8h; IRQ = 3 • IO = 3E8h; IRQ = 3, 4, 5, 6, 7, 9, 10, 11, 12 • IO = 2E8h; IRQ = 3, 4, 5, 6, 7, 9, 10, 11, 12 • IO = 2F0h; IRQ = 3, 4, 5, 6, 7, 9, 10, 11, 12 • IO = 2E0h; IRQ = 3, 4, 5, 6, 7, 9, 10, 11, 12
Device Mode	Serial port 1 loop back / RS232 / RS422 / RS485 mode select.

4.4.4 HW Monitor

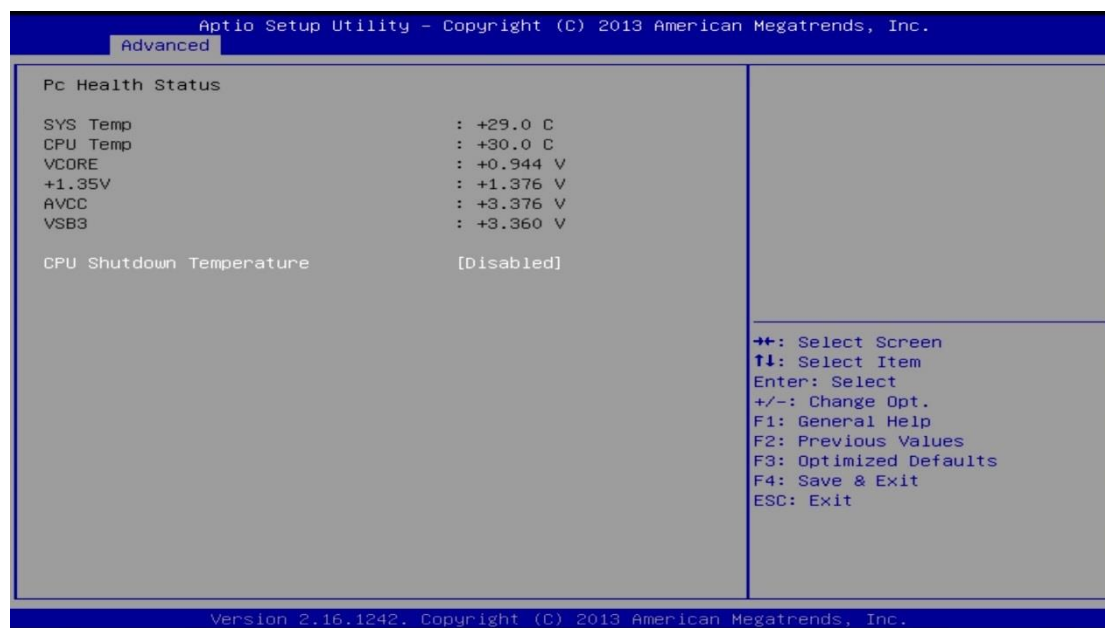

BIOS Setting	Description
CPU Shutdown Temperature	Disables or sets system shutdown temperature to 70°C, 75°C, 80°C, 85°C, 90°C or 95°C.
Temperatures / Voltages	These fields are the parameters of the hardware monitoring function feature of the motherboard. The values are read-only values as monitored by the system and show the PC health status.

4.4.5 CPU Configuration

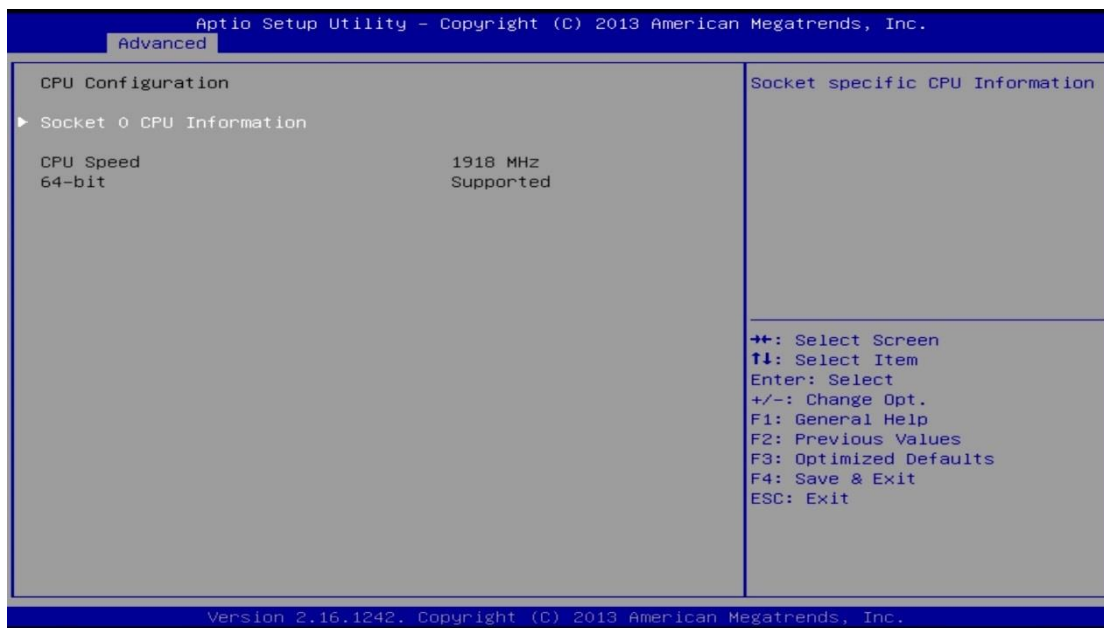

BIOS Setting	Description
Socket 0 CPU Information	Socket specific CPU Information

4.4.6 PPM Configuration

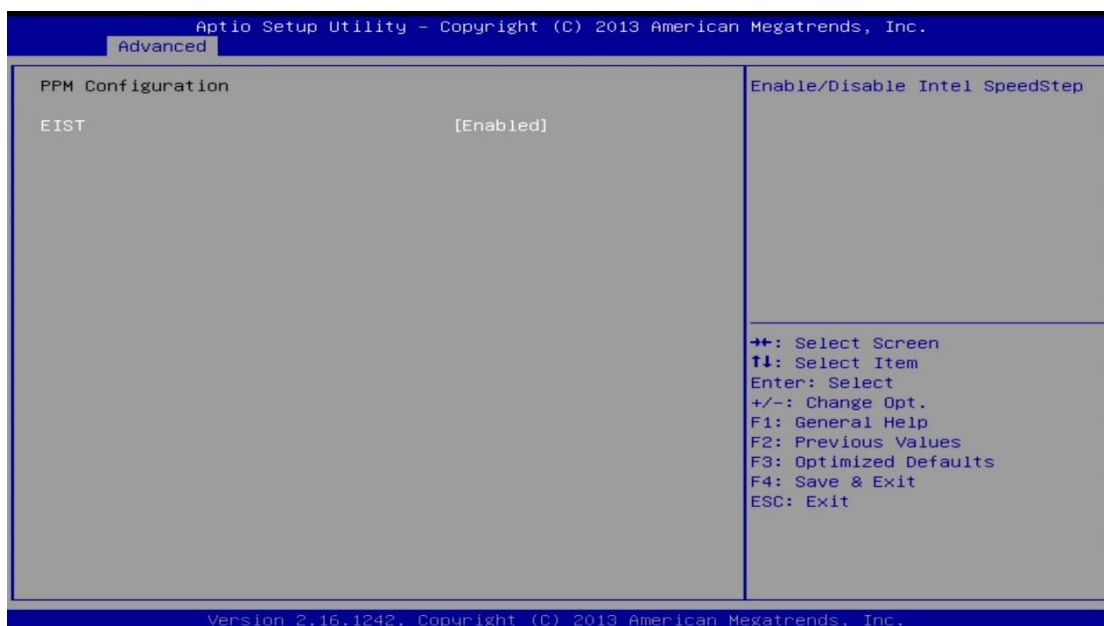

BIOS Setting	Description
EIST	Enables / Disables Intel SpeedStep.

4.4.7 IDE Configuration

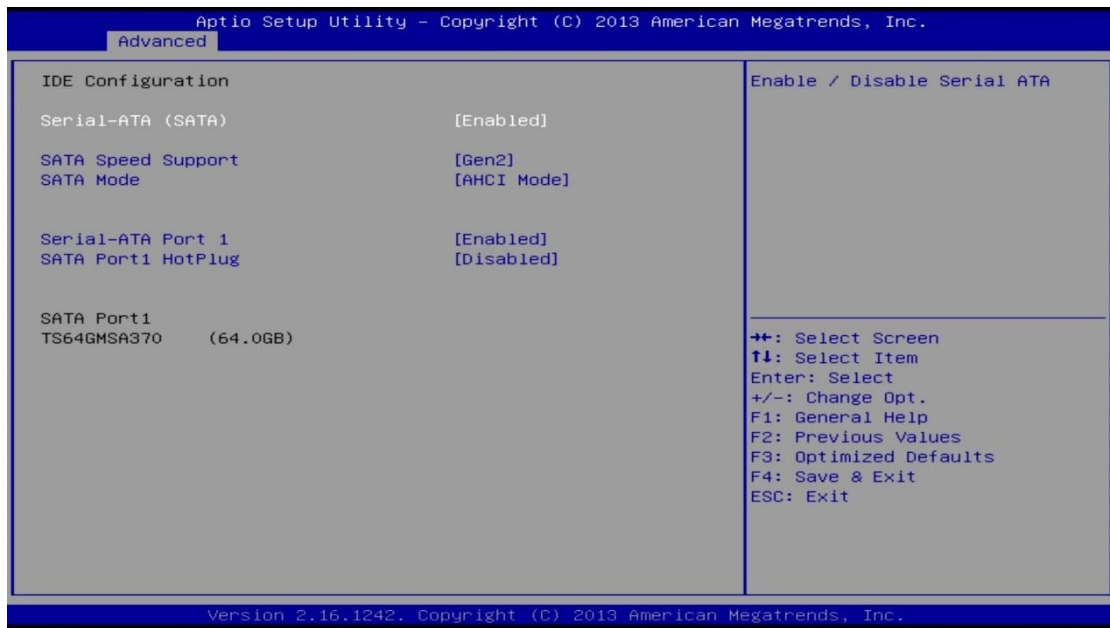

BIOS Setting	Description
Serial ATA (SATA)	Enables / Disables Serial ATA.
SATA Speed Support	Selects SATA speed support as Gen.1 or Gen.
SATA Mode	Selects the SATA mode as IDE or AHCI.
Serial ATA Port 1	Enables / Disables Serial ATA Port 1.
SATA Port 1 HotPlug	Enables / Disables SATA Port 1 HotPlug.

4.4.8 USB Configuration

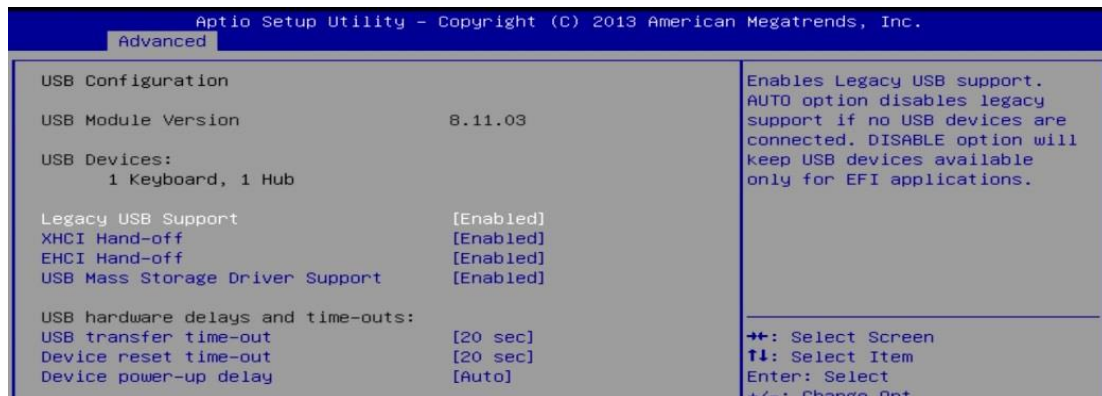

BIOS Setting	Description
Legacy USB Support	<ul style="list-style-type: none"> • Enable: Enables Legacy USB Support. • Auto: Disables legacy support if no USB devices are connected. • Disable: Keeps USB devices available only for EFI applications.
XHCI Hand-off	This is a workaround for OSES without XHCI hand-off support. The XHCI ownership change should be claimed by XHCI driver.
EHCI Hand-off	This is a workaround for OSES without EHCI hand-off support. The EHCI ownership change should be claimed by EHCI driver.
USB Mass Storage Driver Support	Enables / Disables the support for USB mass storage driver.
Port 60/64 Emulation	Enables I/O port 60h/64h emulation support. This should be enabled for the complete USB keyboard legacy support for non-USB aware OSES.
USB Transfer time-out	The time-out value for Control, Bulk, and Interrupt transfers.
Device reset time-out	Seconds of delaying execution of start unit command to USB mass storage device.
Device power-up delay	The maximum time the device will take before it properly reports itself to the Host Controller. "Auto" uses default value for a Root port it is 100ms. But for a Hub port, the delay is taken from Hub descriptor.

4.5 Chipset Settings

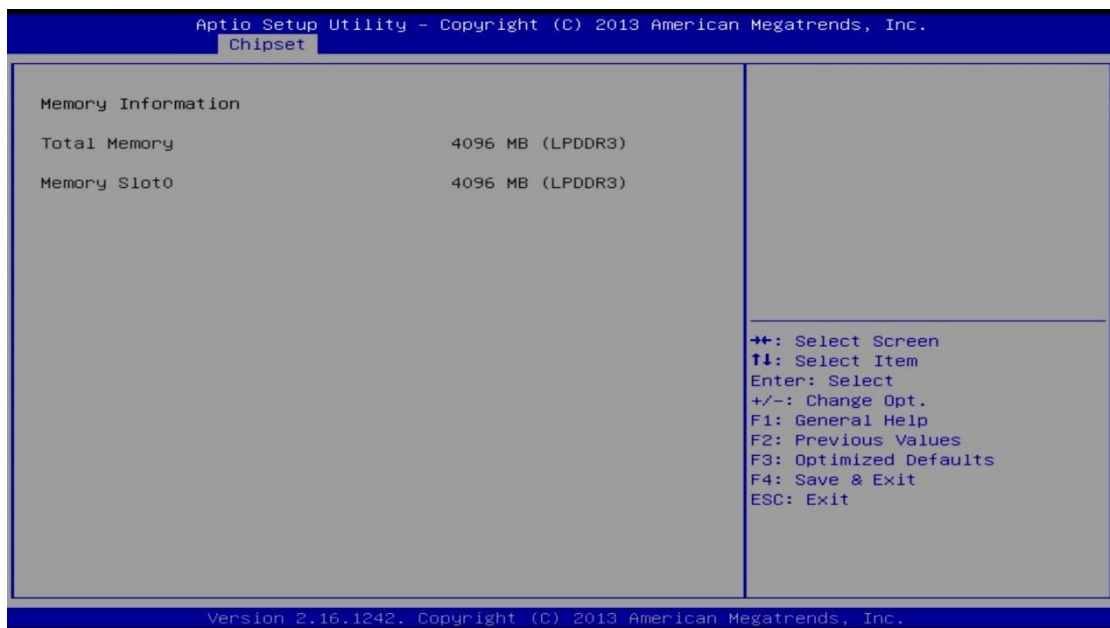
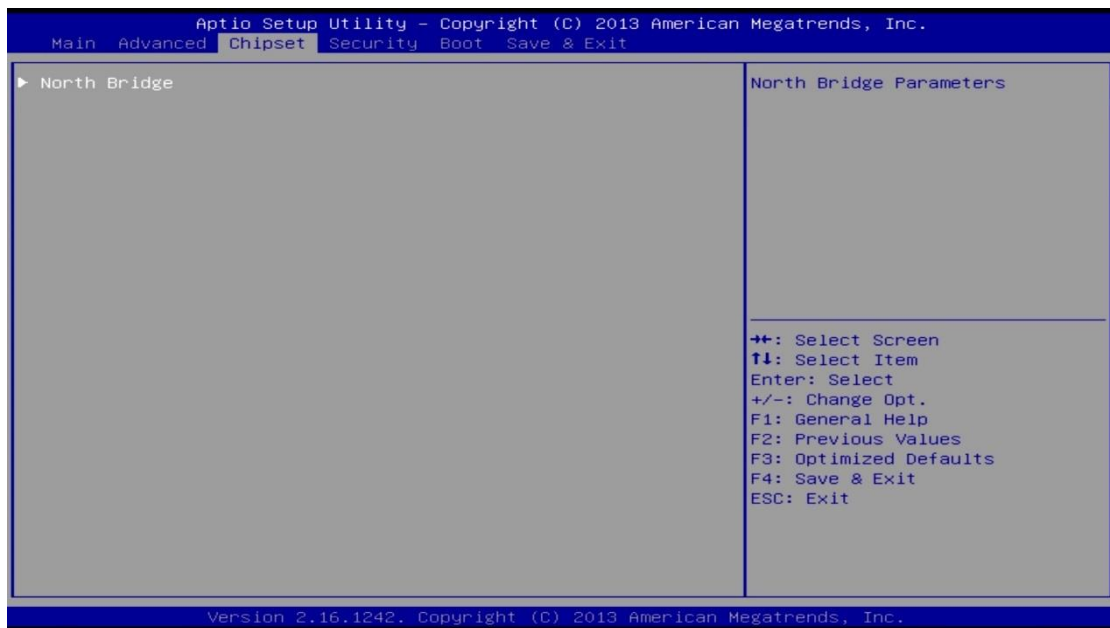

BIOS Setting	Description
North Bridge	Displays the parameters of North Bridge.

4.6 Security Settings



BIOS Setting	Description
Administrator Password	Sets an administrator password for the setup utility.
User Password	Sets a user password.

4.7 Boot Settings

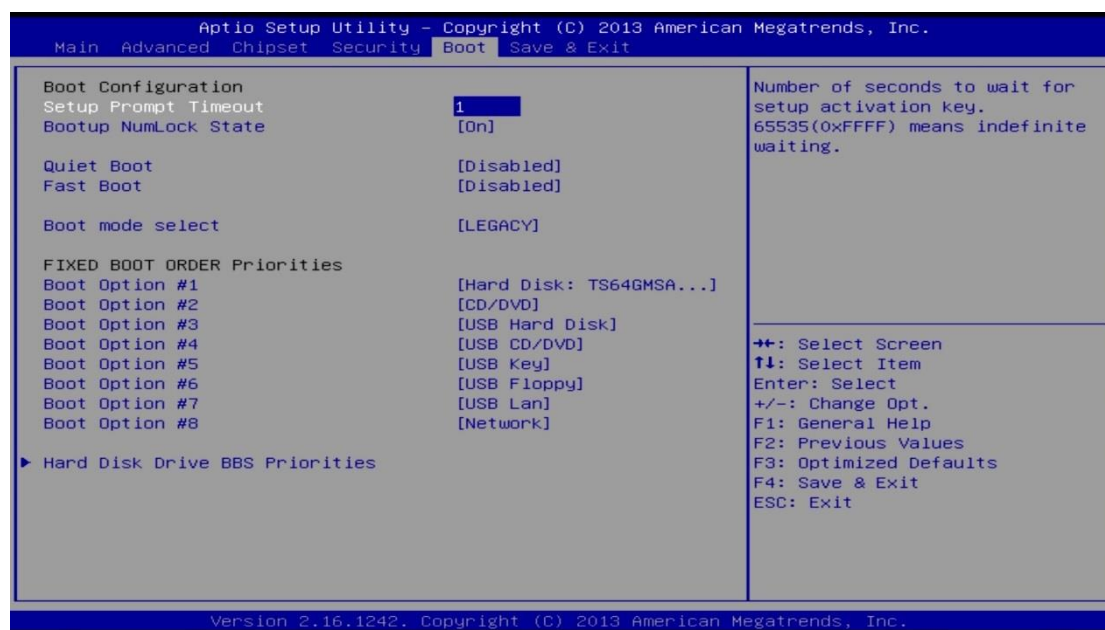

BIOS Setting	Description
Setup Prompt Timeout	Number of seconds to wait for setup activation key. 65535 (0xFFFF) means indefinite waiting.
Bootup NumLock State	Turns on/off the keyboard NumLock state.
Quiet Boot	Enables / Disables Quiet Boot option.
Fast Boot	Enables / Disables boot with initialization of a minimal set of devices required to launch active boot option. Has not effect for BBS boot options.
Boot Mode Select	Selects a Boot mode, Legacy / UEFI.
Boot Option Priorities	Sets the system boot order priorities for hard disk, CD/DVD, USB, Network.
Hard Disk Drive BBS Priorities	Specifies the boot device priority sequence from available UEFI hard disk drives.

4.8 Save & Exit Settings

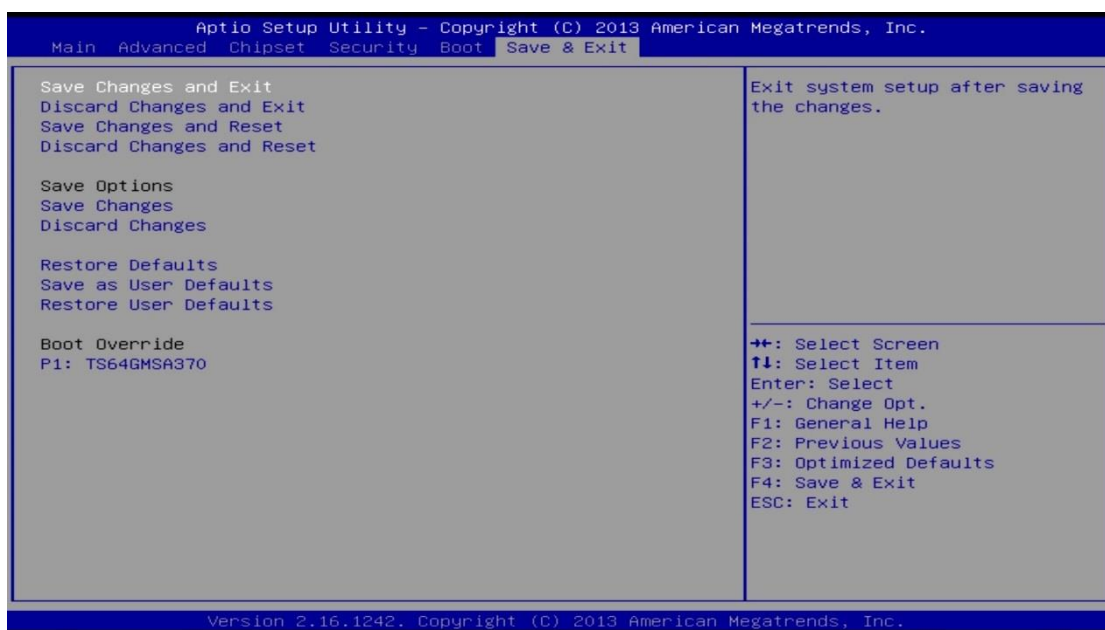

BIOS Setting	Description
Save Changes and Exit	Exits system setup after saving the changes.
Discard Changes and Exit	Exits system setup without saving any changes.
Save Changes and Reset	Resets the system after saving the changes.
Discard Changes and Reset	Resets system setup without saving any changes.
Save Changes	Saves changes done so far to any of the setup options.
Discard Changes	Discards changes done so far to any of the setup options.
Restore Defaults	Restores / Loads defaults values for all the setup options.
Save as User Defaults	Saves the changes done so far as user defaults.
Restore User Defaults	Restores the user defaults to all the setup options.

Appendix

This section provides the mapping addresses of peripheral devices and the sample code of watchdog timer configuration.

- I/O Port Address Map
- Interrupt Request Lines (IRQ)
- Watchdog Timer Configuration

A. I/O Port Address Map

Each peripheral device in the system is assigned a set of I/O port addresses which also becomes the identity of the device. The following table lists the I/O port addresses used.

Address	Device Description
0x00000A00-0x00000A0F	Motherboard resources
0x00000290-0x0000029F	Motherboard resources
0x00000A20-0x00000A2F	Motherboard resources
0x00000A30-0x00000A3F	Motherboard resources
0x0000002E-0x0000002F	Motherboard resources
0x0000004E-0x0000004F	Motherboard resources
0x00000061-0x00000061	Motherboard resources
0x00000063-0x00000063	Motherboard resources
0x00000065-0x00000065	Motherboard resources
0x00000067-0x00000067	Motherboard resources
0x00000070-0x00000070	Motherboard resources
0x00000070-0x00000070	System CMOS/real time clock
0x00000080-0x0000008F	Motherboard resources
0x00000092-0x00000092	Motherboard resources
0x000000B2-0x000000B3	Motherboard resources
0x00000680-0x0000069F	Motherboard resources
0x00000400-0x0000047F	Motherboard resources
0x00000500-0x000005FE	Motherboard resources
0x00000600-0x0000061F	Motherboard resources
0x0000E000-0x0000E01F	Intel(R) Atom(TM)/Celeron(R)/Pentium(R) Processor Platform Control Unit - SMBus Port - 0F12
0x0000D000-0x0000DFFF	Intel(R) Atom(TM)/Celeron(R)/Pentium(R) Processor PCI Express - Root Port 1 - 0F48
0x0000D000-0x0000DFFF	Realtek PCIe GBE Family Controller
0x0000E070-0x0000E077	Standard SATA AHCI Controller
0x0000E060-0x0000E063	Standard SATA AHCI Controller
0x0000E050-0x0000E057	Standard SATA AHCI Controller

Address	Device Description
0x0000E040-0x0000E043	Standard SATA AHCI Controller
0x0000E020-0x0000E03F	Standard SATA AHCI Controller
0x000003F8-0x000003FF	Communications Port (COM1)
0x000003E8-0x000003EF	Communications Port (COM2)
0x00000040-0x00000043	System timer
0x00000050-0x00000053	System timer
0x00000000-0x0000006F	PCI Express Root Complex
0x00000078-0x00000CF7	PCI Express Root Complex
0x00000D00-0x0000FFFF	PCI Express Root Complex
0x0000E080-0x0000E087	Intel(R) HD Graphics
0x000003B0-0x000003BB	Intel(R) HD Graphics
0x000003C0-0x000003DF	Intel(R) HD Graphics
0x00000020-0x00000021	Programmable interrupt controller
0x00000024-0x00000025	Programmable interrupt controller
0x00000028-0x00000029	Programmable interrupt controller
0x0000002C-0x0000002D	Programmable interrupt controller
0x00000030-0x00000031	Programmable interrupt controller
0x00000034-0x00000035	Programmable interrupt controller
0x00000038-0x00000039	Programmable interrupt controller
0x0000003C-0x0000003D	Programmable interrupt controller
0x000000A0-0x000000A1	Programmable interrupt controller
0x000000A4-0x000000A5	Programmable interrupt controller
0x000000A8-0x000000A9	Programmable interrupt controller
0x000000AC-0x000000AD	Programmable interrupt controller
0x000000B0-0x000000B1	Programmable interrupt controller
0x000000B4-0x000000B5	Programmable interrupt controller
0x000000B8-0x000000B9	Programmable interrupt controller
0x000000BC-0x000000BD	Programmable interrupt controller
0x000004D0-0x000004D1	Programmable interrupt controller

B. Interrupt Request Lines (IRQ)

Peripheral devices use interrupt request lines to notify CPU for the service required. The following table shows the IRQ used by the devices on board.

Level	Function
IRQ 3	Intel(R) Atom(TM)/Celeron(R)/Pentium(R) Processor Platform Control Unit - SMBus Port - 0F12
IRQ 4294967291	Intel(R) Trusted Execution Engine Interface
IRQ 8	High precision event timer
IRQ 4294967294	Standard SATA AHCI Controller
IRQ 4	Communications Port (COM1)
IRQ 5	Communications Port (COM2)
IRQ 4294967293	Realtek PCIe GBE Family Controller
IRQ 0	System timer
IRQ 23	Intel(R) Atom(TM)/Celeron(R)/Pentium(R) Processor EHCI USB - 0F34
IRQ 22	High Definition Audio Controller
IRQ 54 ~ IRQ 204	Microsoft ACPI-Compliant System
IRQ 256 ~ IRQ 511	Microsoft ACPI-Compliant System
IRQ 4294967292	Intel(R) HD Graphics

C. Watchdog Timer Configuration

The Watchdog Timer (WDT) is used to generate a variety of output signals after a user programmable count. The WDT is suitable for the use in the prevention of system lock-up, such as when software becomes trapped in a deadlock. Under these sorts of circumstances, the timer will count to zero and the selected outputs will be driven.

Under normal circumstance, you will need to restart the WDT at regular intervals before the timer counts to zero.

1. Sample Code: The file NCT5523D.H

```
//-----  
//  
// THIS CODE AND INFORMATION IS PROVIDED "AS IS" WITHOUT WARRANTY OF ANY  
// KIND, EITHER EXPRESSED OR IMPLIED, INCLUDING BUT NOT LIMITED TO THE  
// IMPLIED WARRANTIES OF MERCHANTABILITY AND/OR FITNESS FOR A PARTICULAR  
// PURPOSE.  
//  
//-----  
#ifndef __NCT5523D_H  
#define __NCT5523D_H                1  
//-----  
#define  NCT5523D_INDEX_PORT      (NCT5523D_BASE)  
#define  NCT5523D_DATA_PORT      (NCT5523D_BASE+1)  
//-----  
#define  NCT5523D_REG_LD          0x07  
//-----  
#define NCT5523D_UNLOCK           0x87  
#define  NCT5523D_LOCK           0xAA  
//-----  
unsigned int Init_NCT5523D(void);  
void Set_NCT5523D_LD( unsigned char);  
void Set_NCT5523D_Reg( unsigned char, unsigned char);  
unsigned char Get_NCT5523D_Reg( unsigned char);  
//-----  
#endif    __NCT5523D_H
```

2. Sample Code: The file MAIN.CPP

```
//-----
//
// THIS CODE AND INFORMATION IS PROVIDED "AS IS" WITHOUT WARRANTY OF ANY
// KIND, EITHER EXPRESSED OR IMPLIED, INCLUDING BUT NOT LIMITED TO THE
// IMPLIED WARRANTIES OF MERCHANTABILITY AND/OR FITNESS FOR A PARTICULAR
// PURPOSE.
//
//-----
#include <dos.h>
#include <conio.h>
#include <stdio.h>
#include <stdlib.h>
#include "NCT5523D.H"
//-----
int main (void);

void WDTInitial(void);
void WDTEnable(unsigned char);
void WDTDisable(void);

//-----
int main (void)
{
    char SIO;

    SIO = Init_NCT5523D();
    if (SIO == 0)
    {
        printf("Can not detect Nuvoton NCT5523D, program abort.\n");
        return(1);
    }

    WDTInitial();

    WDTEnable(10);

    WDTDisable();

    return 0;
}
//-----
void WDTInitial(void)
{
    unsigned char bBuf;
    Set_NCT5523D_LD(0x08);                //switch to logic device 8
    bBuf = Get_NCT5523D_Reg(0x30);
    bBuf &= (~0x01);
    Set_NCT5523D_Reg(0x30, bBuf);        //Enable WDTO
}
//-----
void WDTEnable(unsigned char NewInterval)
{

```

```

unsigned char bBuf;

Set_NCT5523D_LD(0x08);           //switch to logic device 8
Set_NCT5523D_Reg(0x30, 0x01);   //enable timer

bBuf = Get_NCT5523D_Reg(0xF0);
bBuf &= (~0x08);
Set_NCT5523D_Reg(0xF0, bBuf);   //count mode is second

Set_NCT5523D_Reg(0xF1, NewInterval); //set timer
}
//-----
void WDTDisable(void)
{
Set_NCT5523D_LD(0x08);           //switch to logic device 8
Set_NCT5523D_Reg(0xF1, 0x00);   //clear watchdog timer
Set_NCT5523D_Reg(0x30, 0x00);   //watchdog disabled
}
//-----

```

3. Sample Code: The file NCT5523D.CPP

```
//-----
//
// THIS CODE AND INFORMATION IS PROVIDED "AS IS" WITHOUT WARRANTY OF ANY
// KIND, EITHER EXPRESSED OR IMPLIED, INCLUDING BUT NOT LIMITED TO THE
// IMPLIED WARRANTIES OF MERCHANTABILITY AND/OR FITNESS FOR A PARTICULAR
// PURPOSE.
//
//-----
#include "NCT5523D.H"
#include <dos.h>
//-----
unsigned int NCT5523D_BASE;
void Unlock_NCT5523D (void);
void Lock_NCT5523D (void);
//-----
unsigned int Init_NCT5523D(void)
{
    unsigned int result;
    unsigned char ucDid;

    NCT5523D_BASE = 0x4E;
    result = NCT5523D_BASE;

    ucDid = Get_NCT5523D_Reg(0x20);
    if (ucDid == 0xC4)                //NCT5523D??
    {    goto Init_Finish; }

    NCT5523D_BASE = 0x2E;
    result = NCT5523D_BASE;

    ucDid = Get_NCT5523D_Reg(0x20);
    if (ucDid == 0xC4)                //NCT5523D??
    {    goto Init_Finish; }

    NCT5523D_BASE = 0x00;
    result = NCT5523D_BASE;

Init_Finish:
    return (result);
}
//-----
void Unlock_NCT5523D (void)
{
    outportb(NCT5523D_INDEX_PORT, NCT5523D_UNLOCK);
    outportb(NCT5523D_INDEX_PORT, NCT5523D_UNLOCK);
}
//-----
void Lock_NCT5523D (void)
{
    outportb(NCT5523D_INDEX_PORT, NCT5523D_LOCK);
}
//-----
```

```

void Set_NCT5523D_LD( unsigned char LD)
{
    Unlock_NCT5523D();
    outportb(NCT5523D_INDEX_PORT, NCT5523D_REG_LD);
    outportb(NCT5523D_DATA_PORT, LD);
    Lock_NCT5523D();
}
//-----
void Set_NCT5523D_Reg( unsigned char REG, unsigned char DATA)
{
    Unlock_NCT5523D();
    outportb(NCT5523D_INDEX_PORT, REG);
    outportb(NCT5523D_DATA_PORT, DATA);
    Lock_NCT5523D();
}
//-----
unsigned char Get_NCT5523D_Reg(unsigned char REG)
{
    unsigned char Result;
    Unlock_NCT5523D();
    outportb(NCT5523D_INDEX_PORT, REG);
    Result = inportb(NCT5523D_DATA_PORT);
    Lock_NCT5523D();
    return Result;
}
//-----

```