

# **IB200**

**AMD Ryzen™ Embedded R-Series  
2.5-inch SBC**

## **User's Manual**

Version 1.0  
January 2025

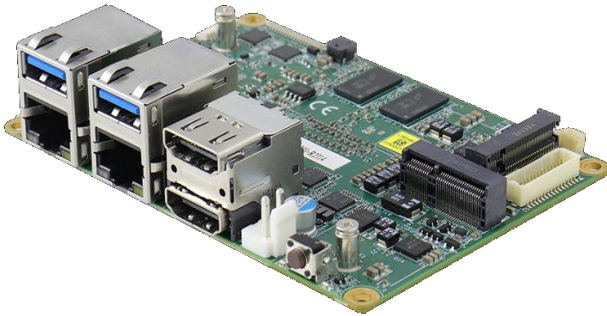

## **Copyright**

© 2025 IBASE Technology, Inc. All rights reserved.

No part of this publication may be reproduced, copied, stored in a retrieval system, translated into any language or transmitted in any form or by any means, electronic, mechanical, photocopying, or otherwise, without the prior written consent of IBASE Technology, Inc.

## **Disclaimer**

Every effort has been made to ensure the information in the document is correct; however, IBASE does not guarantee this document is error-free." - No specific mistake, but you might consider revising the second part of the sentence to something like "However, IBASE cannot guarantee that this document is free of errors.

IBASE assumes no liability for incidental or consequential damages arising from misapplication or inability to use the product or the information contained herein, nor for any infringements of rights of third parties, which may result from its use.

## **Trademarks**

All the trademarks, registrations and brands mentioned herein are used for identification purposes only and may be trademarks and/or registered trademarks of their respective owners.

## Compliance



This is a class B product. In a domestic environment, this product may cause radio interference in which case users may be required to take adequate measures.



This product has been tested and found to comply with the limits for a Class B device, pursuant to Part 15 of the FCC Rules. These limits are designed to provide reasonable protection against harmful interference in a residential installation. This equipment generates, uses and can radiate radio frequency energy and, if not installed and used in accordance with manufacturer's instructions, may cause harmful interference to radio communications.

### WEEE



This product must not be disposed of as normal household waste, in accordance with the EU directive for Waste Electrical and Electronic Equipment (WEEE - 2012/19/EU). Instead, it should be disposed of by returning it to a municipal recycling collection point. Check local regulations for disposal of electronic products.

### Green IBASE



This product complies with RoHS 2 restrictions, which prohibit the use of certain hazardous substances in electrical and electronic equipment. The following substances must not exceed the specified concentrations:

- Hexavalent chromium: 1,000 ppm
- Poly-brominated biphenyls (PBBs): 1,000 ppm
- Poly-brominated diphenyl ethers (PBDEs): 1,000 ppm
- Cadmium: 100 ppm
- Mercury: 1,000 ppm
- Lead: 1,000 ppm
- Bis(2-ethylhexyl) phthalate (DEHP): 1,000 ppm
- Butyl benzyl phthalate (BBP): 1,000 ppm
- Dibutyl phthalate (DBP): 1,000 ppm
- Diisobutyl phthalate (DIBP): 1,000 ppm

## Important Safety Information

Carefully read the precautions before using the board.

### Environmental conditions:

- Use this product in environments with ambient temperatures between 0°C and 60°C.
- Do not leave this product in an environment where the storage temperature may be below -20° C or above 80° C. To prevent damage, the product must be used in a controlled environment.

### Care for your IBASE products:

- Before cleaning the PCB, unplug all cables and remove the battery.
- Clean the PCB with a circuit board cleaner, degreaser, or use cotton swabs and alcohol.
- Vacuum the dust with a computer vacuum cleaner to prevent the fan from being clogged.



### Warning

### Attention during use:

- Do not use this product near water.
- Do not spill water or any other liquids on this product.
- Do not place heavy objects on the top of this product.

### Anti-static precautions

- Wear an anti-static wrist strap to avoid electrostatic discharge.
- Place the PCB on an anti-static kit or mat.
- Hold the edges of PCB when handling.
- Hold the edges of non-metallic components of the product instead of the surface of the PCB.
- Ground yourself by touching a grounded conductor or a grounded bit of metal frequently to discharge any static.



### Caution

Replace only with the same or equivalent type recommended by the manufacturer. Please recycle used batteries at your nearest facility following local guidelines.

## Warranty Policy

- **IBASE standard products:**

24-month (2-year) warranty from the date of shipment. If the date of shipment cannot be ascertained, the product serial numbers can be used to determine the approximate shipping date.

- **3<sup>rd</sup>-party parts:**

12-month (1-year) warranty from delivery for the 3<sup>rd</sup>-party parts that are not manufactured by IBASE, such as CPU, CPU cooler, memory, storage devices, power adapter, panel and touchscreen.

- \* Products that fail due to misuse, accidents, improper installation, or unauthorized repairs will be considered out of warranty. Customers will be responsible for repair and shipping costs.

## Technical Support & Services

1. Visit our website to find the latest information about the product.
2. If you need any further assistance from your distributor or sales representative concerning problems that you may have encountered, please prepare the following information:
  - Product model name
  - Product serial number
  - Detailed description of the problem
  - The error messages in text or in screenshots if there is any
  - The arrangement of the peripherals
  - Software in use (such as OS and application software, including the version numbers)
3. If repair service is required, please contact your represent or our support team at [support@ibt.ca](mailto:support@ibt.ca), to read the warranty and RMA policy, visit our website and look for FAQ about warranty.

# Table of Contents

---

<b>Chapter 1</b>	<b>General Information</b>	<b>1</b>
1.1	Introduction	2
1.2	Features	2
1.3	Packing List	3
1.4	Optional Accessories	3
1.5	Specifications	4
1.6	Block Diagram	5
1.7	Product View	6
1.8	Dimensions	8
<b>Chapter 2</b>	<b>Hardware Configuration</b>	<b>9</b>
2.1	Installations	10
2.1.1	M.2 Card Installation / Replacement	10
2.2	Setting the Jumpers	11
2.3	Connector Locations on IB200	12
2.5	Connector Quick Reference	13
2.5.1	Power Switch (SW1)	14
2.5.2	System Reset (J4)	14
2.5.3	LVDS Connector (J6)	15
2.5.4	M.2 M-key 2280 Socket (J7)	16
2.5.5	USB 2.0 Connector (J8)	17
2.5.6	M.2 E-key 2230 Socket (J10)	18
2.5.7	SATA Connector (J11)	19
2.5.8	Audio Connector (J9)	20
2.5.9	DC Power Input Connector (J12)	21
2.5.10	Digital IO (J14)	22
2.5.11	Debug Port (J15)	23
2.5.12	LCD Backlight Connector (J16)	24
2.5.13	CPU Fan Power Connector (J17)	25
2.5.14	COM1 & COM2 Ports (J18)	26
2.5.15	COM3 & COM4 Ports (J19)	27

<b>Chapter 3</b>	<b>Drivers Installation .....</b>	<b>29</b>
3.1	Introduction .....	30
3.2	AMD Ryzen™ R2000 Chipset Drivers .....	30
3.3	AMD Ryzen™ R2000 Graphics Drivers .....	32
3.4	Realtek High Definition Audio Driver .....	34
3.5	Intel LAN Controller Drivers .....	35
<b>Chapter 4</b>	<b>BIOS Setup .....</b>	<b>39</b>
4.1	Introduction .....	40
4.2	BIOS Setup .....	40
4.3	Main Settings .....	41
4.4	Advanced Settings .....	41
4.5	Chipset Settings .....	51
4.6	Security Settings .....	52
4.7	Boot Settings .....	54
4.8	Save & Exit Settings .....	55

This page is intentionally left blank.

# Chapter 1

## General Information

The information provided in this chapter includes:

- Features
- Packing List
- Specifications
- Block Diagram
- Product View
- Board Dimensions

## 1.1 Introduction

The IB200 is a compact and powerful 2.5-inch Single Board Computer (SBC) that harnesses the advanced computing power of the AMD Ryzen™ Embedded R2000 series APU, featuring the Zen+ architecture with up to 4 cores and 8 threads, ensuring high-performance multitasking capabilities. It comes with onboard DDR memory, supporting up to 8GB to accommodate intensive applications. For visual and display solutions, it offers dual HDMI 2.0b ports and LVDS support, capable of driving high-resolution displays up to 1920x1080 at 60 Hz. Connectivity options are robust, including two GbE LAN ports for high-speed networking, two USB 3.2 Gen2 ports for fast data transfer at 10Gbps with PDPC support, and three USB 2.0 ports for additional peripheral connections. Storage expansion is facilitated through one M.2 (M-key, type 2280) slot and one M.2 (E-key, type 2230) slot, making the IB200 a versatile and efficient choice for a wide range of embedded computing applications.

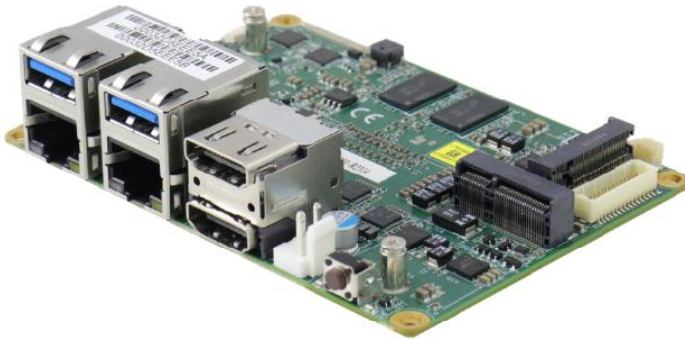

## 1.2 Features

- AMD Ryzen™ Embedded R2000 series APU on board, up to 4 cores/8 threads
- Onboard DDR4 memory, Max. 8GB
- 2x HDMI 2.0b & LVDS: 5V/3.3V, 24 bit, dual channel (LVDS: 1920x1080 @60 Hz)
- 2x GbE LAN, 4x COM, 2x USB 3.2 Gen2 (10Gbps) [with PDPC support], 3x USB 2.0 via pin headers
- Supports 1x M.2 (M-key, type 2280) & 1x M.2 (E-key, type 2230)
- Supports COM1/COM2: RS-232/422/485, COM3/COM4: RS-232
- Energy-efficient 12W-25W thermal design

## 1.3 Packing List

Your product package should include the items listed below. If any of the items below is missing, contact the distributor or dealer from whom you have purchased the product.

- IB200 board

## 1.4 Optional Accessories

IBASE provides optional accessories as listed below.

- SATA Cable (SATA-93 2-HD)

## 1.5 Specifications

<b>Product Name</b>	<b>IB200</b>
<b>Description</b>	AMD Ryzen™ R2000 series(3.5/3.7GHz) 2.5-inch SBC w/ dual LAN, 2x HDMI, LVDS (24-bit dual-channel), 12V DC-in
<b>Form Factor</b>	2.5-inch SBC
<b>System</b>	
<b>Operating System</b>	<ul style="list-style-type: none"> <li>Windows 10 (64-bit)</li> <li>Linux</li> </ul>
<b>CPU &amp; Chipset</b>	AMD Ryzen™ Embedded R2000 Series on board
<b>Memory</b>	Onboard DDR4 memory, Max. 8GB
<b>Storage</b>	<ul style="list-style-type: none"> <li>1x SATA III</li> <li>1x M.2 (M-key)</li> </ul>
Mini Type Slots	<ul style="list-style-type: none"> <li>1x M.2 (M-key, type 2280)</li> <li>1x M.2 (E-key, type 2230)</li> </ul>
<b>Graphics</b>	AMD Radeon™ Vega integrated
<b>Ethernet</b>	2x Intel® I226IT Gigabit LAN
<b>Super I/O</b>	Fintek F81966AB-I
<b>Serial Port</b>	<ul style="list-style-type: none"> <li>COM1 / COM2 : RS-232/422/485 (Default: RS-232, adjustable via BIOS)</li> <li>COM3 / COM4 : RS232</li> </ul>
<b>USB 2.0</b>	3x USB 2.0 via pin header
<b>USB 3.x</b>	2x USB 3.2 Gen2 (10Gbps)
<b>Audio Codec</b>	Built-in audio w/ Realtek audio codec ALC888S-VD2-GR
<b>TPM</b>	2.0
<b>Others</b>	Digital I/O
<b>Dimensions</b>	100mm x 72mm
<b>RoHS</b>	Yes
<b>Environment</b>	
<b>Temperature</b>	<ul style="list-style-type: none"> <li>Operating: 0 ~ 60 °C (32 ~ 140 °F)</li> <li>Storage: -20 ~ 80 °C (-4 ~ 176 °F)</li> </ul>
<b>Relative Humidity</b>	0 ~ 90%, non-condensing at 60 °C

## 1.6 Block Diagram

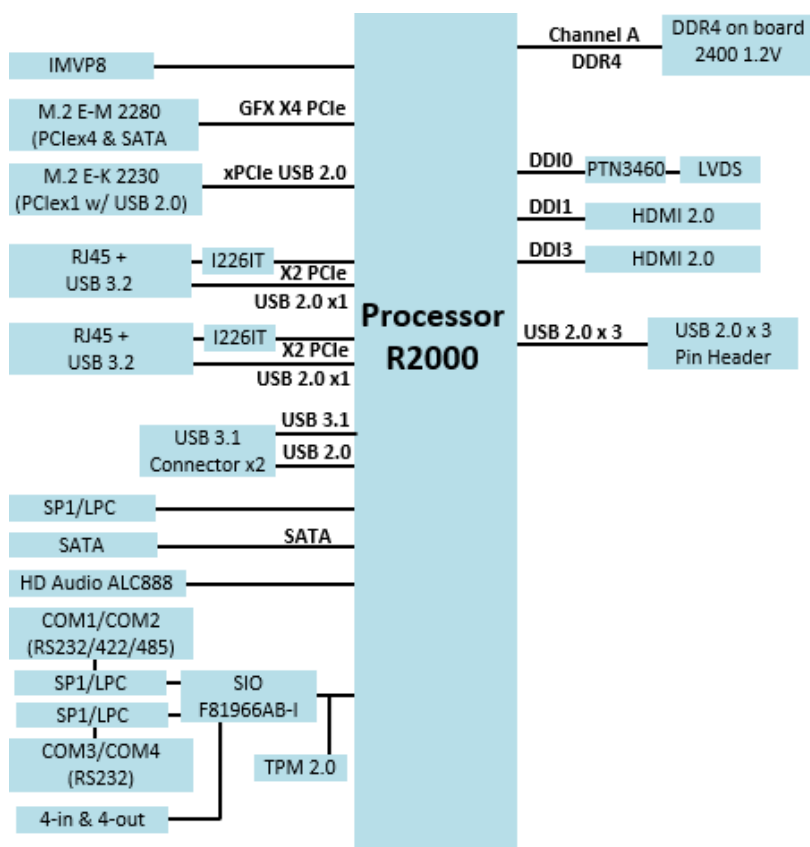

# 1.7 Product View

## Top / Bottom / I/O View

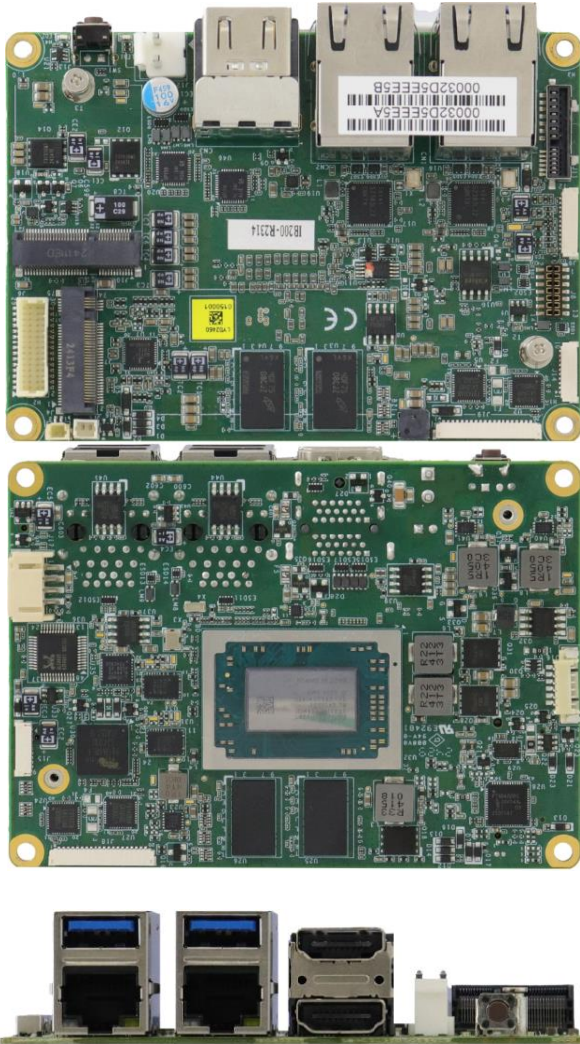

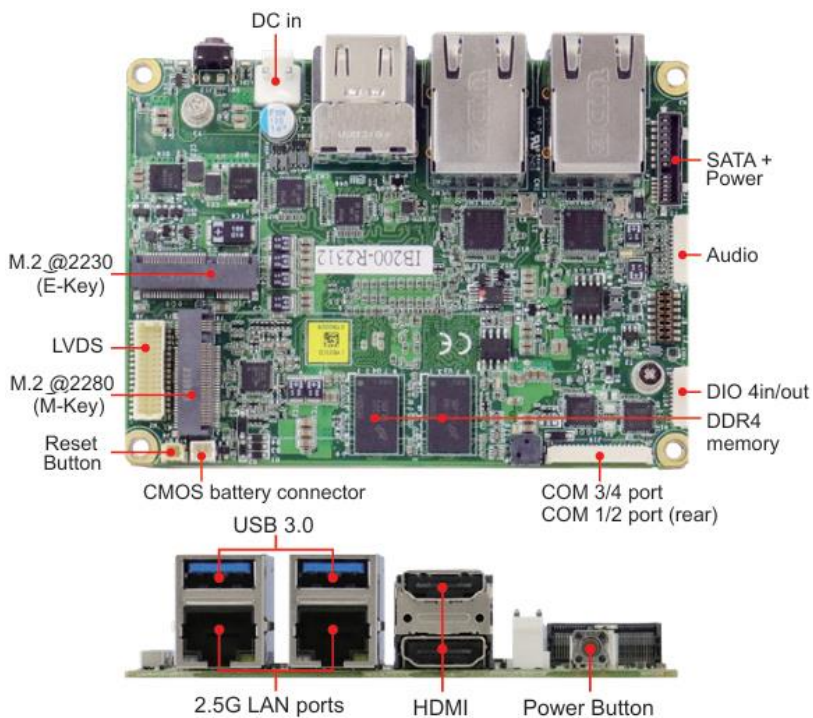

# 1.8 Dimensions

Unit: in mm

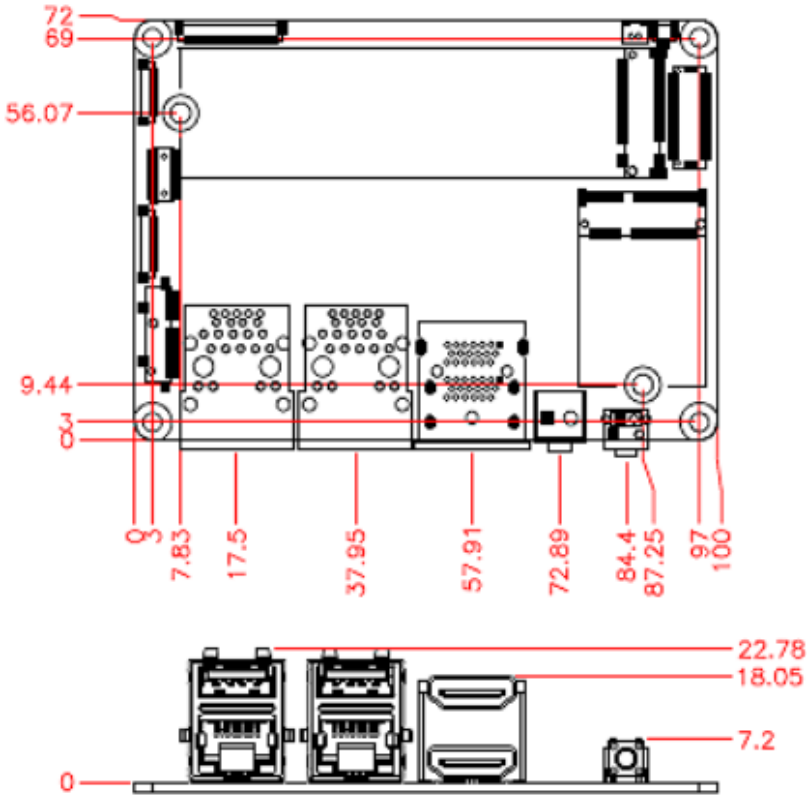

# Chapter 2

## Hardware Configuration

This section provides information on jumper settings and connectors on the board in order to set up a workable system. On top of that, you will also need to install crucial pieces such as the CPU and the memory before using the product. The topics covered are:

- Memory installation
- Jumper and connector locations
- Jumper settings and connectors information

## 2.1 Installations

### 2.1.1 M.2 Card Installation / Replacement

1. Locate the M.2 slot.
2. Align the key of the M.2 card to the interface, and insert the card slantwise.
3. Push the M.2 card down and fix it with the an M3 screw.

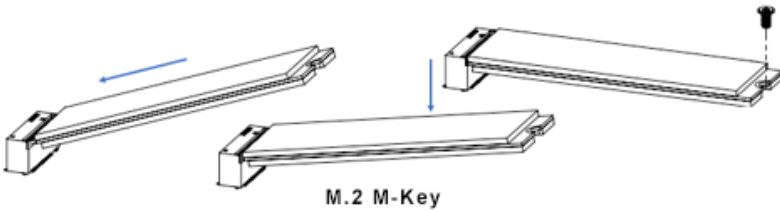

## 2.2 Setting the Jumpers

Set up and configure your board by using jumpers for various settings and features according to your needs and applications. Contact your supplier if you have doubts about the best configuration for your use.

### 2.2.1 How to Set Jumpers

Jumpers are short-length conductors consisting of several metal pins with a non-conductive base mounted on the circuit board. Jumper caps are used to have the functions and features enabled or disabled. If a jumper has 3 pins, you can connect either PIN1 to PIN2 or PIN2 to PIN3 by shorting.

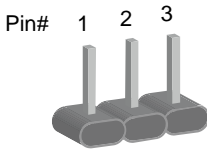

A 3-pin jumper

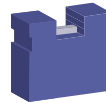

A jumper cap

Refer to the illustration below to set jumpers.

Pin closed	Oblique view	Illustration
Open		
1-2		
2-3		

When two pins of a jumper are encased in a jumper cap, this jumper is **closed**, i.e. turned **On**.

When a jumper cap is removed from two jumper pins, this jumper is **open**, i.e. turned **Off**.

## 2.3 Connector Locations on IB200

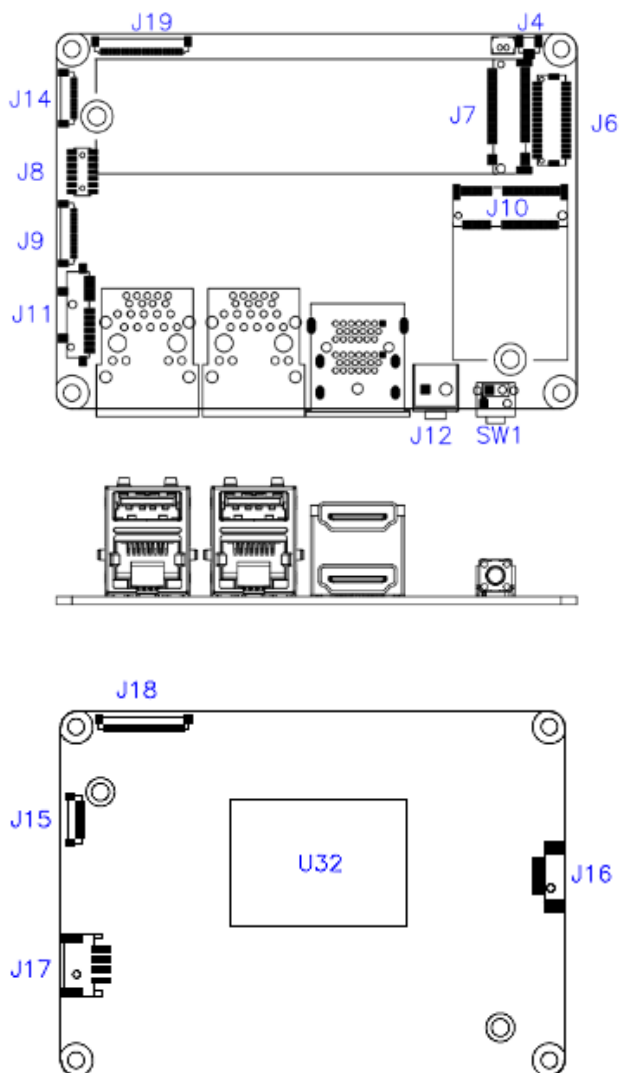

## 2.5 Connector Quick Reference

Function	Connector
Power Switch	SW1
System Reset	J4
LVDS Connector	J6
M.2 M-key 2280 Socket	J7
USB 2.0 Connector	J8
M.2 E-key 2230 Socket	J10
SATA Connector	J11
Audio Connector	J9
DC Power Input Connector	J12
Digital IO	J14
Debug Port	J15
LCD Backlight Connector	J16
CPU Fan Power Connector	J17
COM1 & COM2 Ports	J18
COM3 & COM4 Ports	J19

### 2.5.1 Power Switch (SW1)

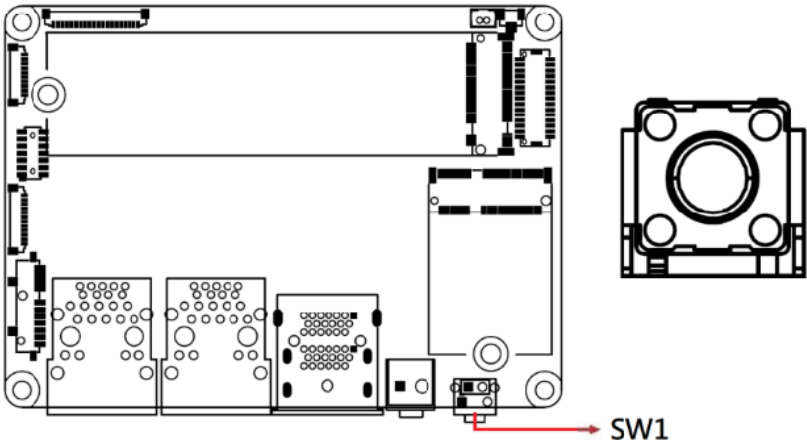

### 2.5.2 System Reset (J4)

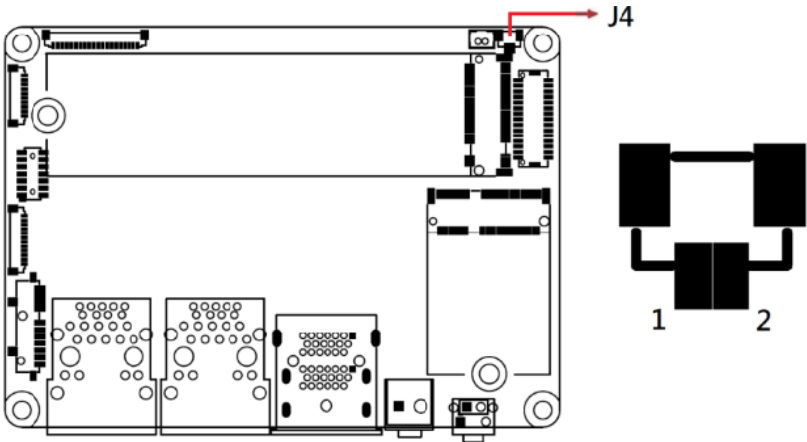

Pin	Assignment
1	Reset
2	Ground

## 2.5.3 LVDS Connector (J6)

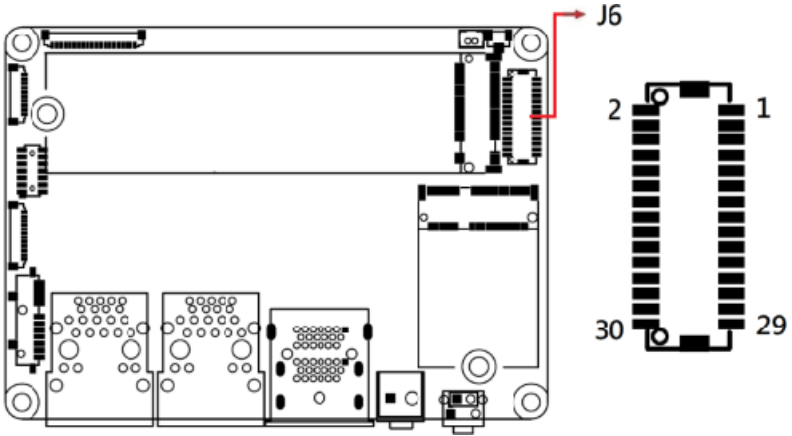

Pin	Assignment	Pin	Assignment
1	LVSDE_P	2	LVSDO_P
3	LVSDE_N	4	LVSDO_N
5	GND	6	GND
7	LVSCKE_P	8	LVSCKO_P
9	LVSCKE_N	10	LVSCKO_N
11	GND	12	GND
13	LVSCE_P	14	LVSCO_N
15	LVSCE_N	16	LVSCO_P
17	GND	18	GND
19	LVSBE_P	20	LVSBO_P
21	LVSBE_N	22	LVSBO_N
23	GND	24	GND
25	LVSAE_P	26	LVSAO_N
27	LVSAE_N	28	LVSAO_P
29	VDD	30	VDD

### 2.5.4 M.2 M-key 2280 Socket (J7)

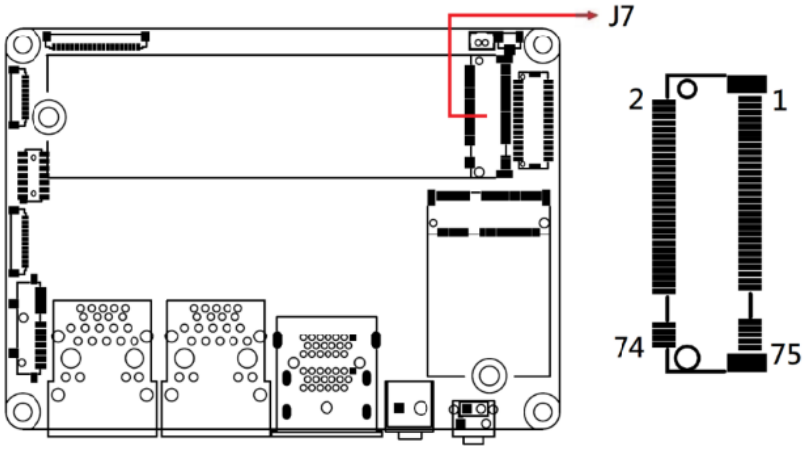

## 2.5.5 USB 2.0 Connector (J8)

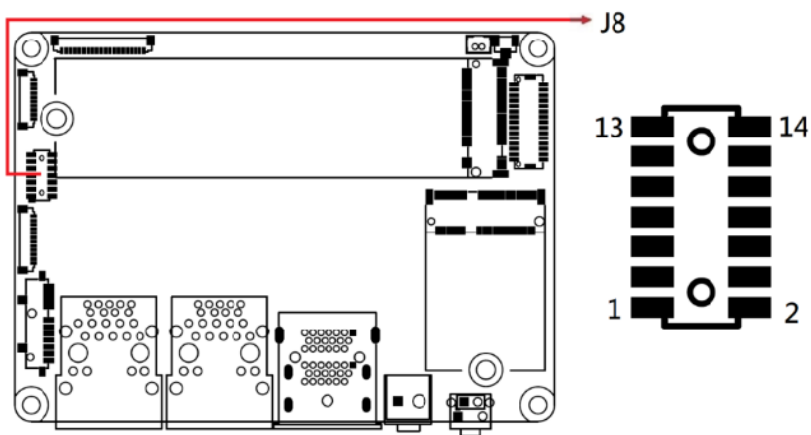

Pin	Assignment	Pin	Assignment
1	VCC	2	VCC
3	D0-	4	D1-
5	D0+	6	D1+
7	Ground	8	Ground
9	VCC5	10	VCC5
11	D2-	12	Ground
13	D2+	14	VCC

## 2.5.6 M.2 E-key 2230 Socket (J10)

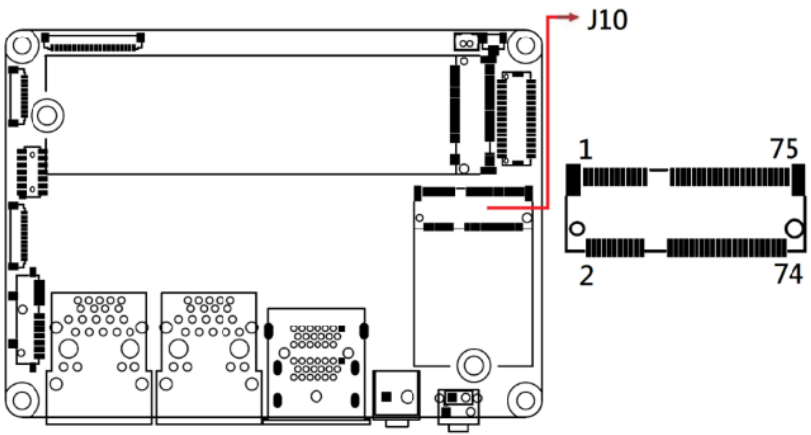

## 2.5.7 SATA Connector (J11)

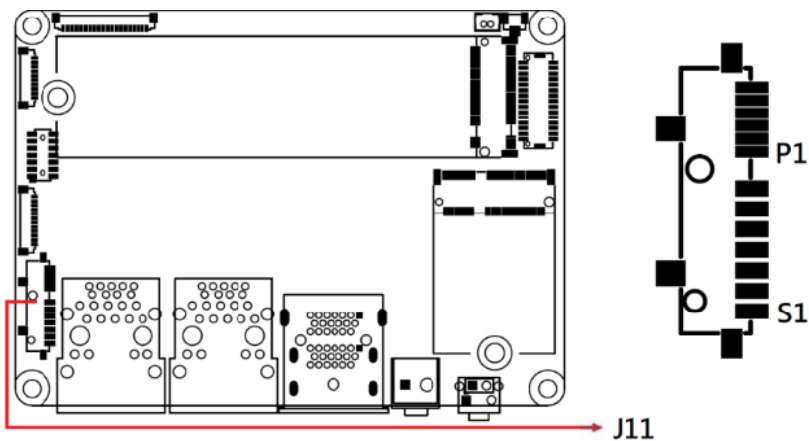

Pin	Assignment	Pin	Assignment
1	GND	P1	NC
S2	SATA_TXP0	P2	NC
S3	SATA_TXN0	P3	GND
S4	GND	P4	GND
S5	SATA_RXN0	P5	+5V
S6	SATA_RXP0	P6	+5V
S7	GND		

## 2.5.8 Audio Connector (J9)

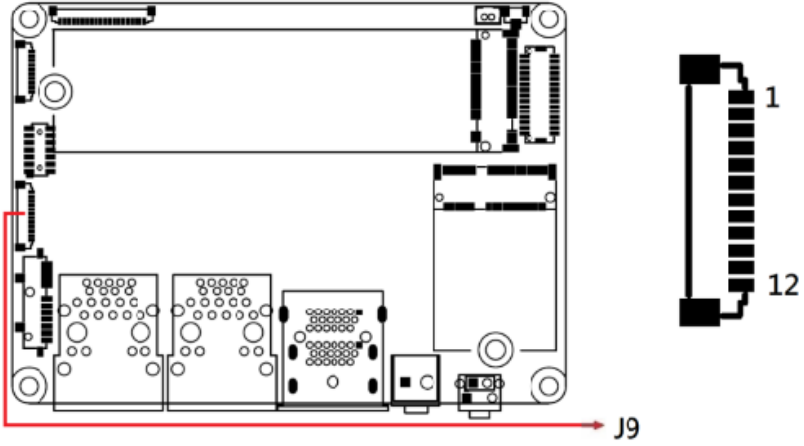

Pin	Assignment
1	GND
2	LINE_OUT_R
3	LINE_OUT_L
4	JD_FRONT
5	GND
6	LINE_IN_R
7	LINE_IN_L
8	JD_LINEIN
9	GND
10	MIC1_R
11	MIC1_L
12	JD_MIC1

### 2.5.9 DC Power Input Connector (J12)

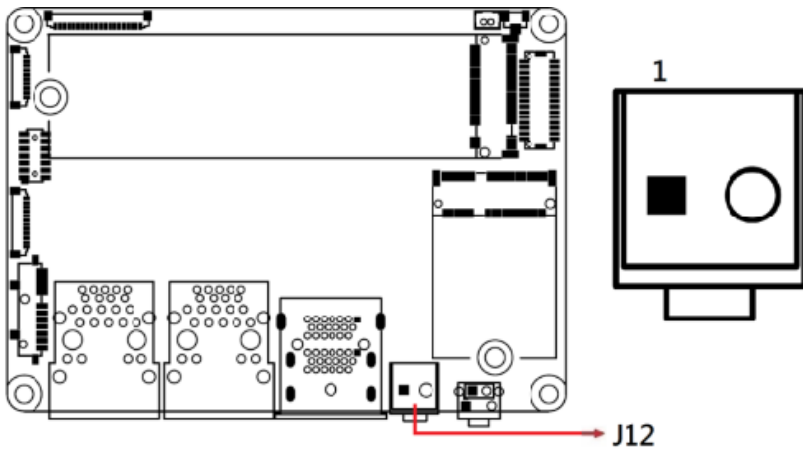

Pin	Assignment
1	+12V
2	Ground

### 2.5.10 Digital IO (J14)

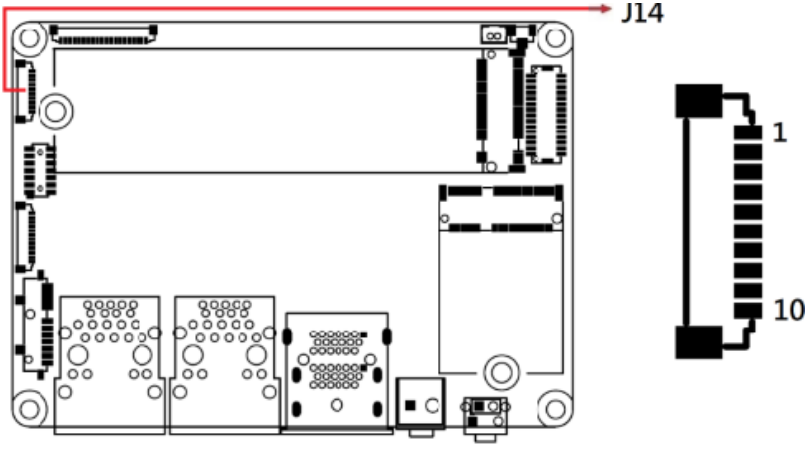

Pin	Assignment
1	+5V
2	OUT0
3	OUT1
4	OUT2
5	OUT3
6	GND
7	IN0
8	IN1
9	IN2
10	IN3

## 2.5.11 Debug Port (J15)

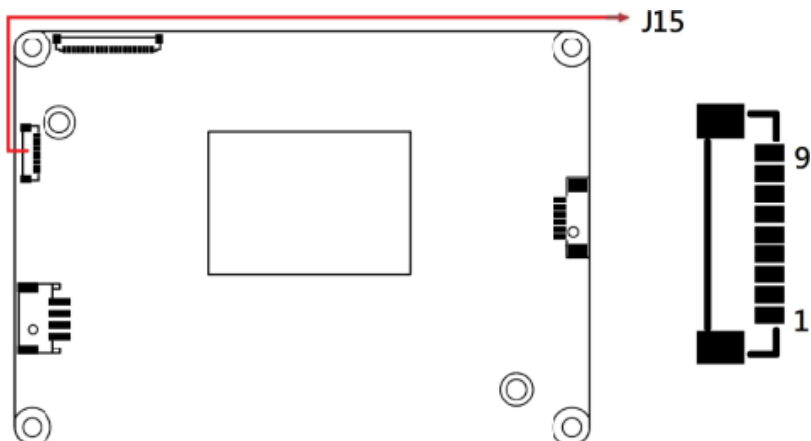

Pin	Assignment
1	+3.3V
2	LPC_RST#
3	LPC_FRAME#
4	GND
5	LPC_AD0
6	LPC_AD1
7	LPC_AD2
8	LPC_AD3
9	LPC_CLK0

### 2.5.12 LCD Backlight Connector (J16)

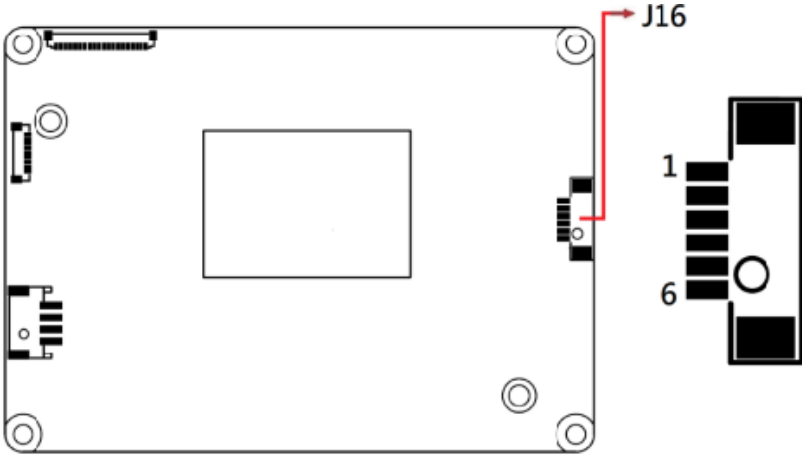

Pin	Assignment
1	+12V
2	+12V
3	GND
4	GND
5	Backlight Enable
6	Brightness Control

### 2.5.13 CPU Fan Power Connector (J17)

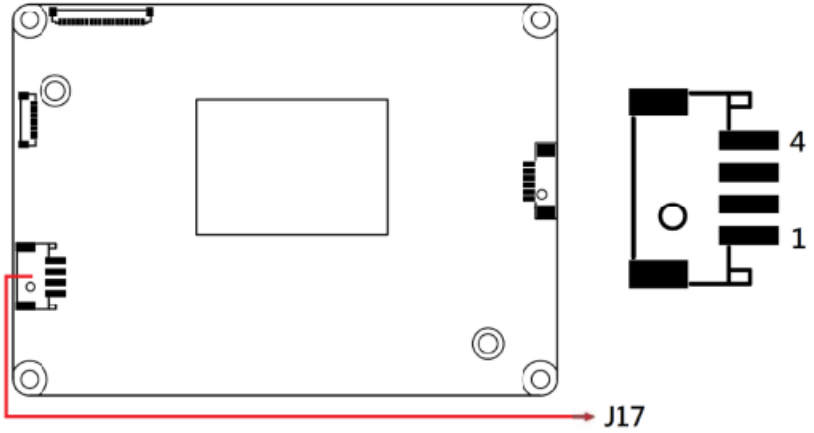

Pin	Assignment	Pin	Assignment
1	Ground	3	Rotation detection
2	+12V	4	Control

### 2.5.14 COM1 & COM2 Ports (J18)

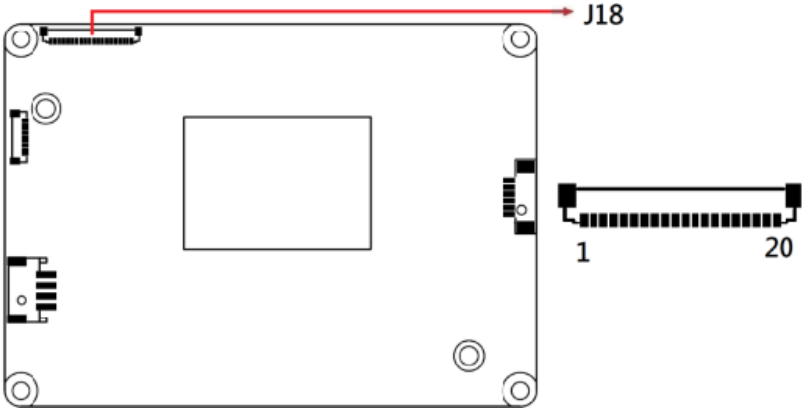

Pin	Assignment	Pin	Assignment
1	DCD#1	11	DCD#2
2	SIN1	12	SIN2
3	SOUT1	13	SOUT2
4	DTR#1	14	DTR#2
5	GND	15	GND
6	DSR#1	16	DSR#2
7	RTS#1	17	RTS#2
8	CTS#1	18	CTS#2
9	RI#1	19	RI#2
10	RI#1	20	RI#2

## 2.5.15 COM3 &amp; COM4 Ports (J19)

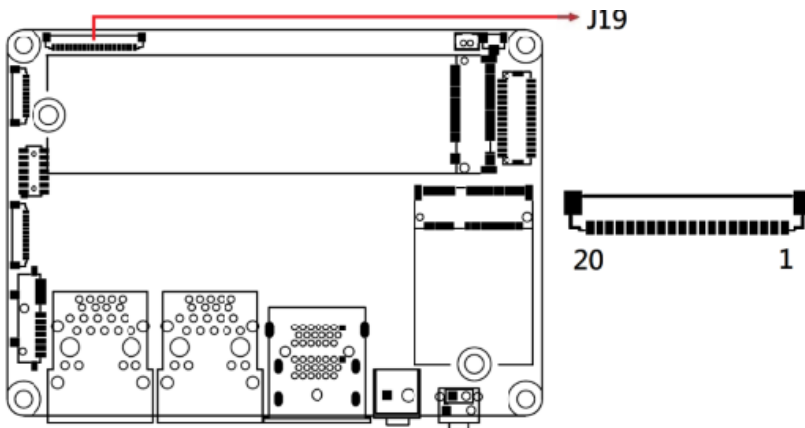

Pin	Assignment	Pin	Assignment
1	DCD#3	11	DCD#4
2	SIN3	12	SIN4
3	SOUT3	13	SOUT4
4	DTR#3	14	DTR#4
5	GND	15	GND
6	DSR#3	16	DSR#4
7	RTS#3	17	RTS#4
8	CTS#3	18	CTS#4
9	RI#3	19	RI#4
10	RI#3	20	RI#4

This page is intentionally left blank.

# Chapter 3

## Drivers Installation

This chapter introduces installation of the following drivers:

- AMD Ryzen™ R2000 Chipset Drivers
- AMD Ryzen™ R2000 Graphics Drivers
- Realtek High Definition Audio Driver
- Intel LAN Controller Drivers

### 3.1 Introduction

This section guides you through installing software and drivers.

### 3.2 AMD Ryzen™ R2000 Chipset Drivers

1. Go to the download page of the product. Copy the compressed drivers file to your computer. Double click the file to decompress it. Run “CDGuide” to go to the main drivers page as shown below. Click **AMD** on the left pane and then **AMD Ryzen R2000 Drivers** on the right.

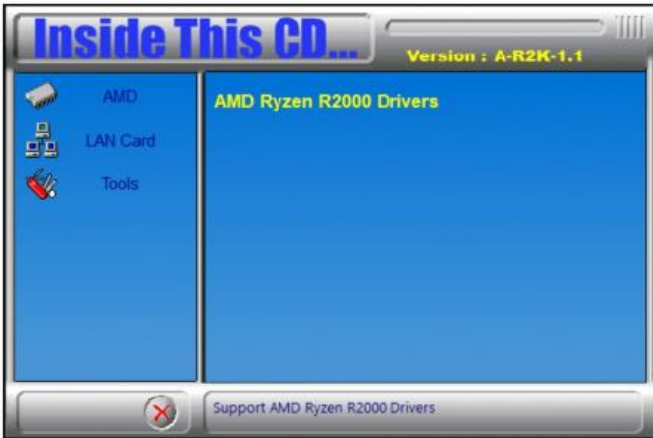

2. Click **AMD Ryzen R2000 Chipset Drivers**.

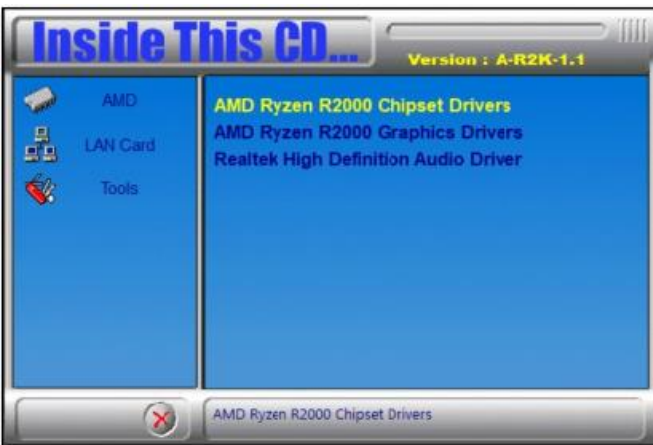

### 3 Driver Installation

3. On the following screen (AMD Chipset Software Installer), click **Install**.

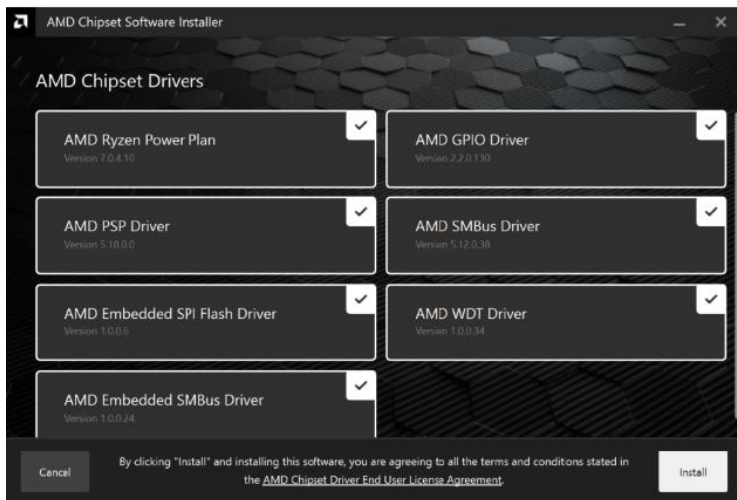

4. After the AMD Chipset Software is installed successfully, click **Restart**.



### 3.3 AMD Ryzen™ R2000 Graphics Drivers

1. Click **AMD** on the left pane and then **AMD Ryzen R2000 Drivers** on the right pane.

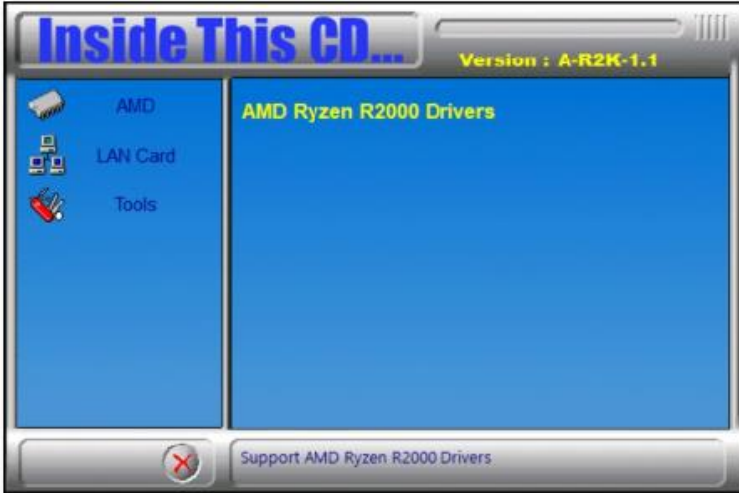

2. Click **AMD Ryzen R2000 Graphics Drivers**.

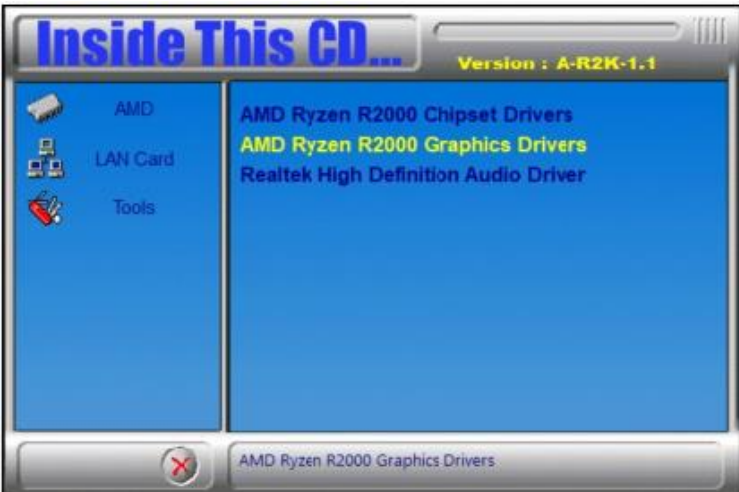

### 3 Driver Installation

3. On the following screen (AMD Radeon PRO Software Installer), click **Install**.



4. To complete the installation process, click Restart.



### 3.4 Realtek High Definition Audio Driver

1. Click **AMD** on the left pane and then **AMD Ryzen R2000 Drivers** on the right pane.

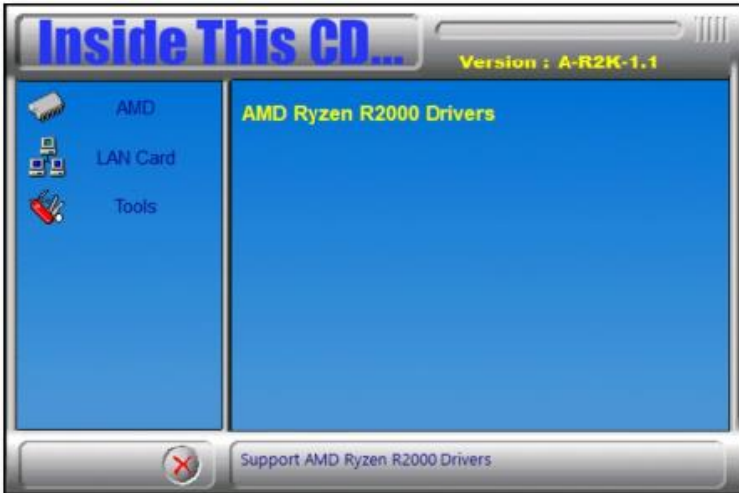

2. Click **Realtek High Definition Audio Driver**.

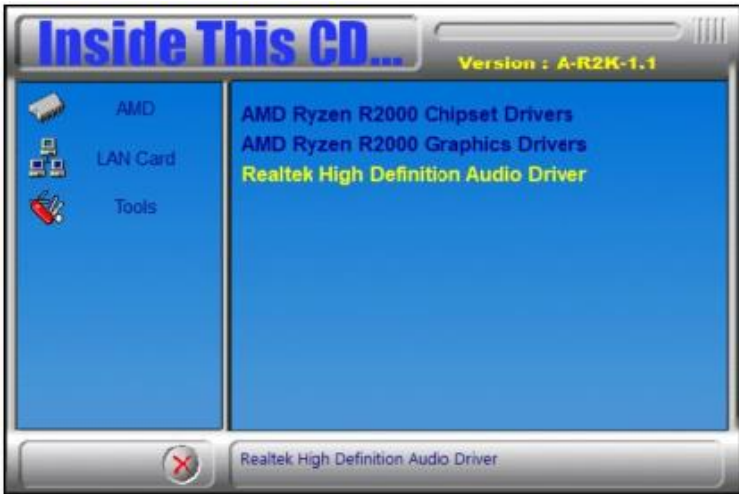

3. On the Welcome screen to the InstallShield Wizard for the audio driver, click **Next** to continue the installation.

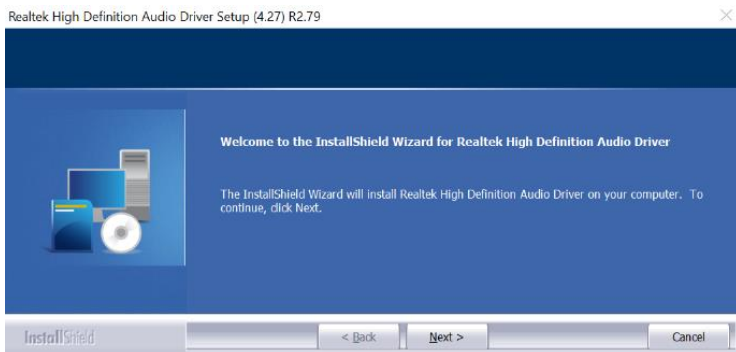

4. When the InstallShield Wizard has completed the audio driver installation, you must restart your computer.



### 3.5 Intel LAN Controller Drivers

1. Click **LAN Card** on the left pane and then **Intel LAN Controller Drivers** on the right pane.

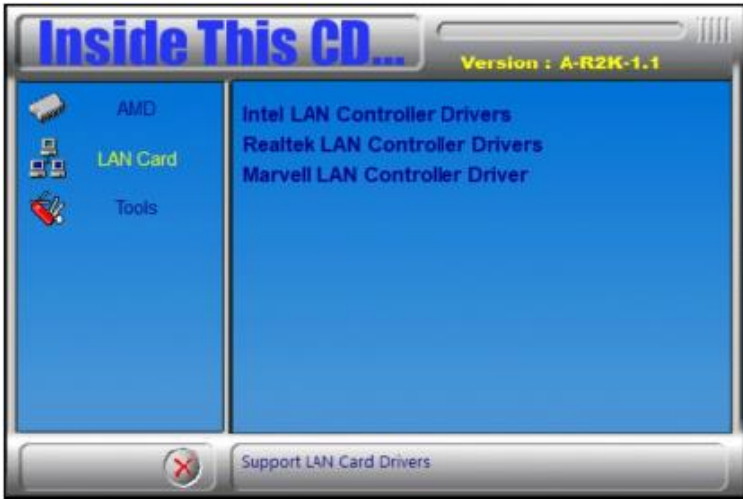

2. Click **Intel(R) I21x / I22x Gigabit Network Drivers**.

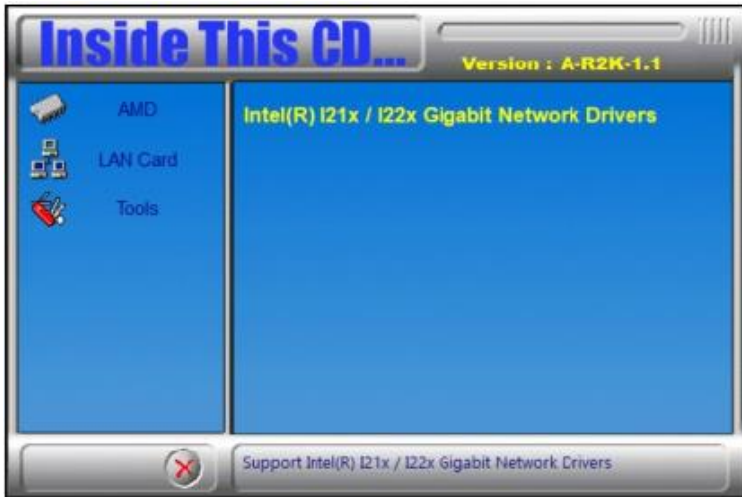

3. On the next screen, click **Install Drivers and Software** to continue.

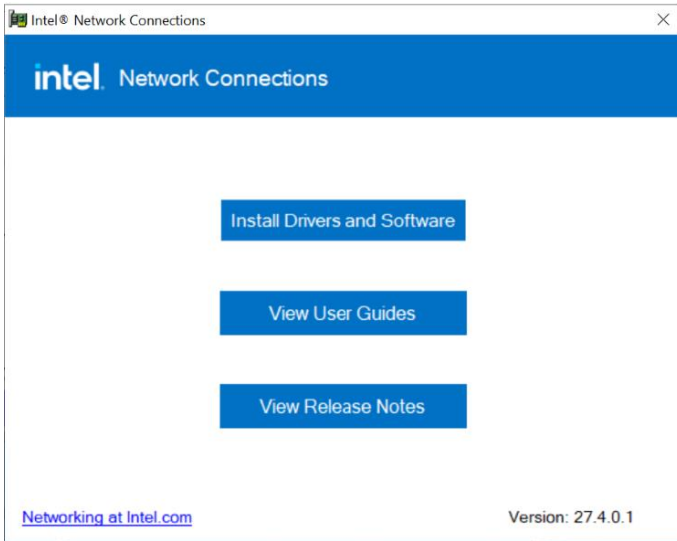

4. On the Welcome screen to the Install wizard for the Intel® Network Connections, click **Next**.

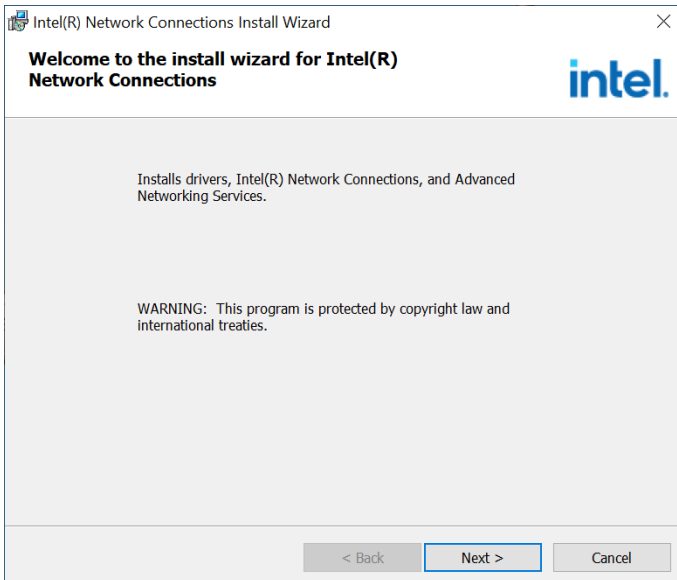

- On the next screen, click **Next** to accept the terms in the license agreement.
- Select the program features to be **installed in the Setup Options** and click **Next**.

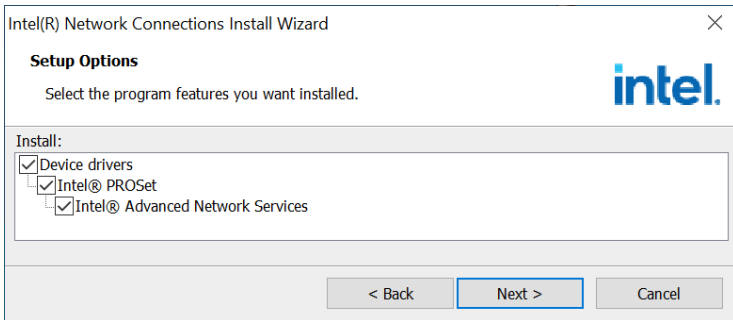

- On the following screen (Ready to Install the Program), click **Install** to begin the installation.

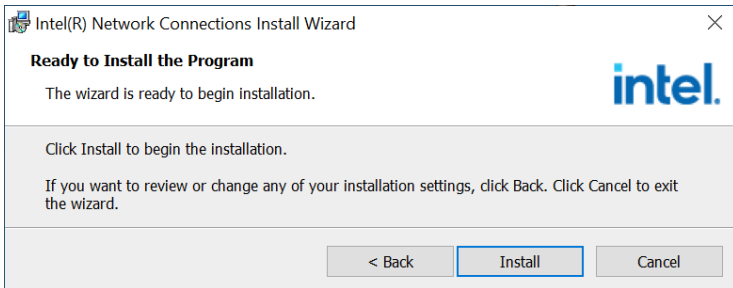

- On the next screen (**Install wizard Completed**), click **Finish**.

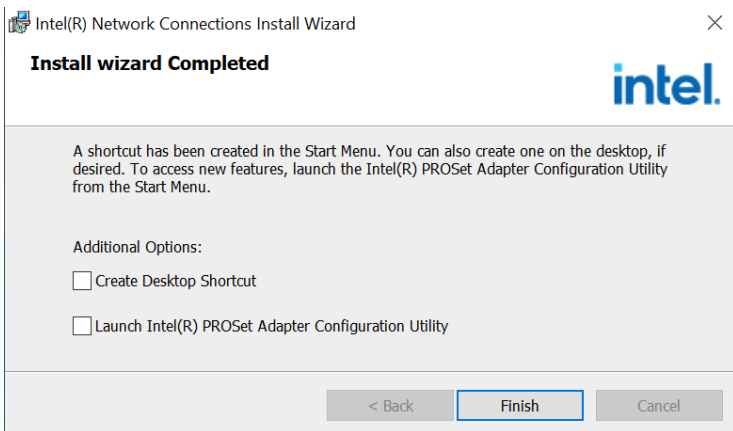

# Chapter 4

## BIOS Setup

This chapter describes the different settings available in the AMI BIOS that comes with the board. The topics covered in this chapter are as follows:

- Main Settings
- Advanced Settings
- Chipset Settings
- Boot Settings
- Security Settings
- Save & Exit

## 4.1 Introduction

The BIOS (Basic Input/Output System) installed in the ROM of your computer system supports AMD APU. The BIOS provides critical low-level support for standard devices such as disk drives, serial ports and parallel ports. It also provides password protection as well as special support for detailed fine-tuning of the chipset controlling the entire system.

## 4.2 BIOS Setup

The BIOS provides a Setup utility program for specifying the system configurations and settings. The BIOS ROM of the system stores the Setup utility. When you turn on the computer, the BIOS is immediately activated. Press the <Del> key immediately allows you to enter the Setup utility. If you are a little bit late pressing the <Del> key, POST (Power On Self Test) will continue with its test routines, thus preventing you from invoking the Setup.

If you still need to enter Setup, restart the system by pressing the "Reset" button or simultaneously pressing the <Ctrl>, <Alt> and <Delete> keys. You can also restart by turning the system Off and back On again.

The following message will appear on the screen:

```
Press <DEL> to Enter Setup
```

In general, press the arrow keys to highlight items, <Enter> to select, the <PgUp> and <PgDn> keys to change entries, <F1> for help, and <Esc> to quit.

When you enter the BIOS Setup utility, the *Main Menu* screen will appear on the screen. The Main Menu allows you to select from various setup functions and exit choices.

---

**Warning:** It is strongly recommended that you avoid making any changes to the chipset defaults.

These defaults have been carefully chosen by both AMI and your system manufacturer to provide the absolute maximum performance and reliability. Changing the defaults could make the system unstable and crash in some cases.

---

### 4.3 Main Settings

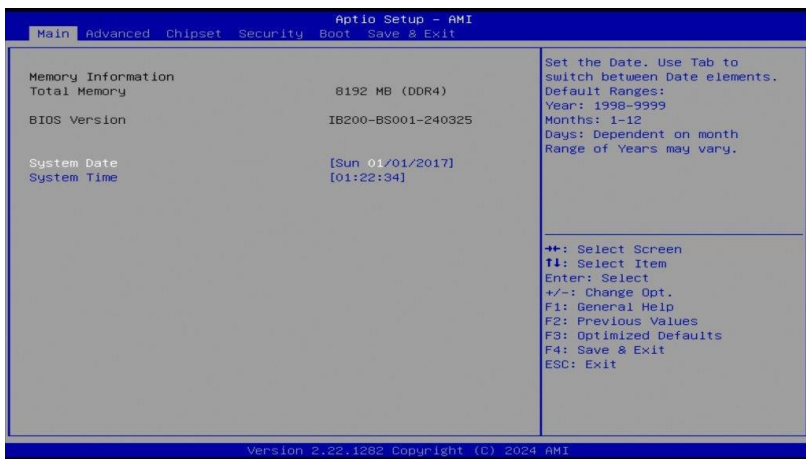

BIOS Setting	Description
System Date	Sets the date. Use the <Tab> key to switch between the date elements.
System Time	Set the time. Use the <Tab> key to switch between the time elements.

### 4.4 Advanced Settings

This section allows you to configure, improve your system and allows you to set up some system features according to your preference.



## 4.4.1 Trusted Computing

TPM 2.0 Device Found	
Firmware Version:	3.78
Vendor:	AMD
Security Device Support	[Enable]
Active PCR banks	SHA256
Available PCR banks	SHA256
SHA256 PCR Bank	[Enabled]
Pending operation	[None]
Platform Hierarchy	[Enabled]
Storage Hierarchy	[Enabled]
Endorsement Hierarchy	[Enabled]
Physical Presence Spec Version	[1.3]
TPM 2.0 InterfaceType	[CRB]
Device Select	[Auto]

BIOS Setting	Description
Security Device Support	Enables / Disables BIOS support for security device. O.S. will not show security device. TCG EFI protocol and INT1A interface will not be available.
SHA256 PCR Bank	Options: Enable or Disable
Pending operation	Schedule an operation for the security device. Note: Your computer will reboot during restart in order to change state of security device.
Platform / Storage / Endorsement Hierarchy	Options: Enable or Disable
TPM2.0 UEFI Spec Version	Select the TCG2 Spec Version Support. TCG_1_2: the compatible mode for Win8/Win10. TCG_2: Support new TCG2 protocol and event format for Win10 or later.
Physical Presence Spec Version	Select to tell O.S. to support PPI Spec Version 1.2 or 1.3. Note: some HCK tests might not support 1.3.
Device Select	TPM 1.2 will restrict support to TPM 1.2 devices. TPM 2.0 will restrict support to TPM 2.0 devices. Auto will support both with the default set to TPM 2.0 devices. If not found, TPM 1.2 devices will be enumerated.

## 4.4.2 ACPI Settings

```

ACPI Settings
Enable ACPI Auto Configuration      [Disabled]
Enable Hibernation                  [Disabled]
ACPI Sleep State                    [Suspend Disabled]

```

BIOS Setting	Description
Enable ACPI Auto Configuration	Enables / Disables BIOS ACPI auto configuration.
Enable Hibernation	Enables / Disables the system ability to hibernate (OS/S4 Sleep State). This option may be not effective with some OS.
ACPI Sleep State	Selects an ACPI sleep state where the system will enter when the Suspend button is pressed.

## 4.4.3 IDE Configuration

```

IDE Configuration
SATA Port0      Not Present
SATA Port1     Not Present

```

BIOS Setting	Description
SATA Ports	Detects the connection of SATA0 and SATA1.

#### 4.4.4 LVDS Configuration

```

LVDS Configuration

LVDS Control           [Enabled]
Panel Type             [1920 x 1080]
LVDS Backlight Control [7(Max)]
    
```

```

LVDS Configuration

LVDS Control           [Enabled]
Panel Type             [Panel Type
800 x 480
800 x 600
1024 x 768
1280 x 768
1280 x 800
1280 x 960
1280 x 1024
1366 x 768
1440 x 900
1600 x 900
1600 x 1200
1680 x 1050
1920 x 1080
1920 x 1200
    
```

BIOS Setting	Description
LVDS Control	Options: Enable or Disable
Panel Type	Options: 800 x 480, 800 x 600, 1024 x 768, 1280 x 768, 1280 x 800, 1280 x 960, 1280 x 1024, 1366 x 768, 1440 x 900, 1600 x 900, 1600 x 1200, 1680 x 1050, 1920 x 1080, 1920 x 1200
LVDS Backlight Control	Options: 0(Min), 1, 2, 3, 4, 5, 6, 7 (Max)

## 4.4.5 F81966 Super IO Configuration

```

FB1966 Super IO Configuration

Super IO Chip                               F81966
Serial Port 1 Configuration
Serial Port 2 Configuration
Serial Port 3 Configuration
Serial Port 4 Configuration
  
```

BIOS Setting	Description
Serial Ports Configuration	Sets parameters of Serial Ports. Enables / Disables the serial port and select an optimal setting for the Super IO device.

### Serial Port 1~4 Configuration

```

Serial Port 1 Configuration

Serial Port                               [Enabled]
Device Settings                           ID=3F8h; IRQ=4
Change Settings                           [Auto]
SERIAL PORT MODE SELECT                   [RS232 Mode]

Serial Port 2 Configuration

Serial Port                               [Enabled]
Device Settings                           ID=2F8h; IRQ=3
Change Settings                           [Auto]
SERIAL PORT MODE SELECT                   [RS232 Mode]

Serial Port 3 Configuration

Serial Port                               [Enabled]
Device Settings                           ID=3E8h; IRQ=10
Change Settings                           [Auto]

Serial Port 4 Configuration

Serial Port                               [Enabled]
Device Settings                           ID=2E8h; IRQ=11
Change Settings                           [Auto]
  
```

## 4.4.6 Hardware Monitor

```
PC Health Status
CPU Fan smart fan control      [Disabled]
CPU temperature                : +41 C
System temperature            : +40 C
CPU Fan Speed                  : 5747 RPM
Vcore                          : +1.216 V
+5V                            : +5.003 V
+12V                           : +11.792 V
Memory Voltage                 : +1.208 V
VCC3V                          : +3.328 V
```

BIOS Setting	Description
CPU Smart Fan Control	Options: Disabled, 50C, 60C, 70C, 80C
Temperatures / Voltages	These fields are the parameters of the hardware monitoring function feature of the motherboard. The values are read-only values as monitored by the system and show the PC health status.

### 4.4.7 CPU Configuration

CPU Configuration	View Memory Information related to Node 0
Node 0 Information	

```
Socket0: AMD Ryzen Embedded R2312 with Radeon Graphics
2 Core(s) Running @ 2724 MHz 1218 mV
Processor Family: 17h
Processor Model: 10h-1Fh
CPUID: 00810F81
```

BIOS Setting	Description
Node 0 Information	Displays the memory information related to Node 0.

### 4.4.8 AMI Graphic Output Protocol Policy

```
RAVEN
AMD GOP X64 Release Driver Rev.2.8.0.0.0.Jul 26 20
Output Select [DFP2_HDMI]
```

```
RAVEN
AMD GOP X64 Release Driver Rev.2.8.0.0.0.Jul 26 20
Output Select [DFP2_HDMI]
```

Output Select  
 DFP2\_HDMI

BIOS Setting	Description
Output Select	Allows you to select an output interface.

## 4.4.9 USB Configuration

```

USB Configuration

USB Module Version                28

USB Controllers:
  2 XHCIs
USB Devices:
  1 Keyboard

Legacy USB Support                [Enabled]
XHCI Hand-off                    [Enabled]
USB Mass Storage Driver Support  [Enabled]
Port 60/64 Emulation            [Enabled]

USB hardware delays and time-outs:
USB transfer time-out            [20 sec]
Device reset time-out          [20 sec]
Device power-up delay          [Auto]
  
```

BIOS Setting	Description
Legacy USB Support	<p>Enables Legacy USB support.</p> <ul style="list-style-type: none"> <li>• <b>Auto</b> disables legacy support if there is no USB device connected.</li> <li>• <b>Disable</b> keeps USB devices available only for EFI applications.</li> </ul>
XHCI Hand-off	<p>This is a workaround for OSes without XHCI hand-off support. The XHCI ownership change should be claimed by XHCI driver.</p>
USB Mass Storage Driver Support	<p>Enables / Disables the support for USB mass storage driver.</p>
Port 60/64 Emulation	<p>Enables I/O port 50h/64h emulation support. This should be enabled for the complete USB keyboard legacy support for non-USB aware OSes.</p>
USB Transfer time-out	<p>The time-out value for control, bulk, and Interrupt transfers. Options: 1 sec / 5 sec / 10 sec / 20 sec</p>
Device reset time-out	<p>Seconds of delaying execution of start unit command to USB mass storage device. Options: 10 sec / 20 sec / 30 sec / 40 sec</p>
Device power-up delay	<p>The maximum time the device will take before it properly reports itself to the Host Controller. <b>Auto</b> uses default value for a Root port it is 100ms. But for a Hub port, the delay is taken from Hub descriptor. Options: Auto / Manual</p>

### 4.4.10 Network Stack Configuration

Advanced	
Network Stack	[Disabled]
Network Stack	[Enabled]
IPv4 PXE Support	[Disabled]
IPv4 HTTP Support	[Disabled]
IPv6 PXE Support	[Disabled]
IPv6 HTTP Support	[Disabled]
PXE boot wait time	0
Media detect count	1

BIOS Setting	Description
Network Stack	Enables / Disables UEFI Network Stack
IPv4 PXE Support	Enables / Disables IPv4 PXE Boot Support. If disabled, lpv4 PXE boot option will not be available.
IPv4 HTTP Support	Enables / Disables IPv4 HTTP Boot Support. If disabled, lpv4 HTTP boot option will not be available.
IPv6 PXE Support	Enables / Disables IPv6 PXE Boot Support. If disabled, lpv4 PXE boot option will not be available.
IPv6 HTTP Support	Enables / Disables IPv6 HTTP Boot Support. If disabled, lpv4 HTTP boot option will not be available.
PXE boot wait time	Assigns a period of time to press ESC key to abort the PXE boot.
Media detect count	Assigns a number of times to check the presence of media.

### 4.4.11 CSM Configuration

Trusted Computing	CSM configuration: Enable/Disable, Option ROM execution settings, etc.
ACPI Settings	
IDE Configuration	
LVDS Configuration	
F81966 Super IO Configuration	
Hardware Monitor	
CPJ Configuration	
AMI Graphic Output Protocol Policy	
USB Configuration	
Network Stack Configuration	
CSM Configuration	

Compatibility Support Module Configuration	
CSM Support	[Enabled]

## 4.4.12 NVMe Configuration

Trusted Computing ACPI Settings IDE Configuration LVDS Configuration FB1966 Super IO Configuration Hardware Monitor CPU Configuration AMI Graphic Output Protocol Policy USB Configuration Network Stack Configuration CSM Configuration NVMe Configuration	NVMe Device Options Settings
--	------------------------------

NVMe Configuration

No NVME Device Found

## 4.4.13 AMD CBS

Trusted Computing ACPI Settings IDE Configuration LVDS Configuration FB1966 Super IO Configuration Hardware Monitor CPU Configuration AMI Graphic Output Protocol Policy USB Configuration Network Stack Configuration CSM Configuration NVMe Configuration	AMD CBS Setup Page
AMD CBS	++: Select Screen **

AMD CBS	FCH Common Options
FCH Common Options	

FCH Common Options	Ac Power Loss Options
Ac Power Loss Options	

Ac Power Loss Options	Select Ac Loss Control Method
Ac Loss Control	[Always On]

## 4.5 Chipset Settings

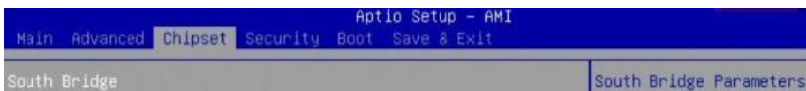

### 4.5.1 SB USB Configuration

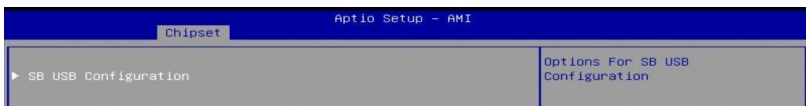

BIOS Setting	Description
SB USB Configuration	Options for SB USB Configuration.

#### 4.5.1.1. XHCI Ports

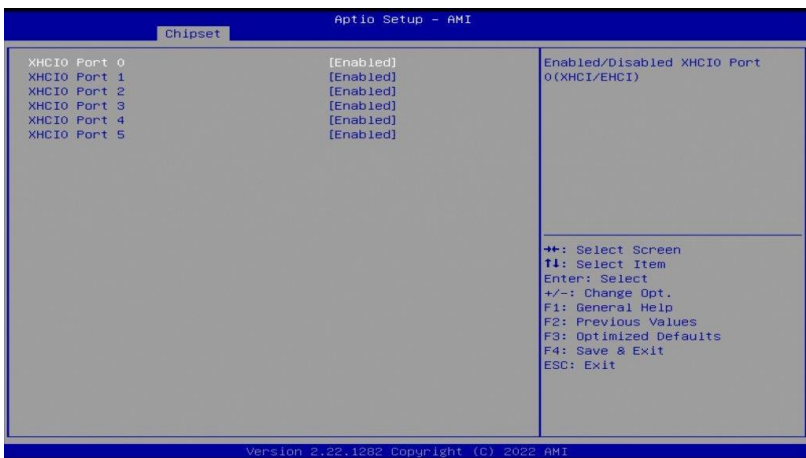

BIOS Setting	Description
XHCI 0 & XHCI 1 Ports	Enables / Disables the XHCI0 & XHCI1 ports (XHCI/EMCI).

## 4.6 Security Settings

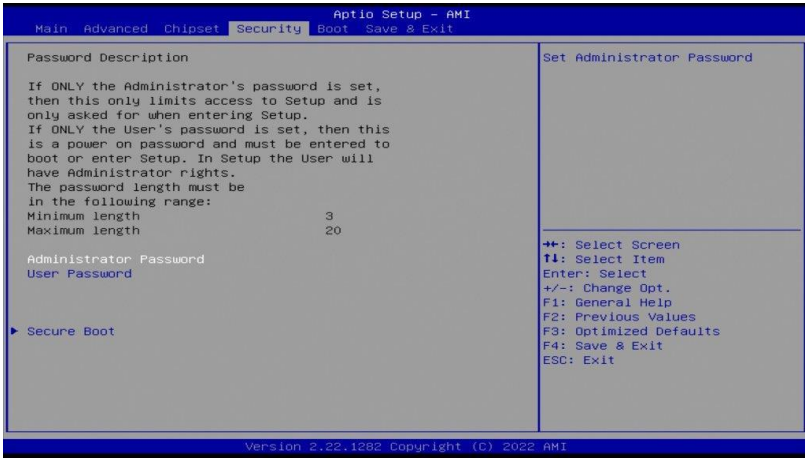

BIOS Setting	Description
Administrator Password	Sets an administrator password for the setup utility.
User Password	Sets a user password.



BIOS Setting	Description
Secure Boot	Secure Boot feature is active if Secure Boot is enabled. Platform Key(PK) is enrolled and the system is in user mode. The mode change requires platform reset.
Secure Boot Mode	Secure Boot mode options: Standard or Custom. In Custom mode, Secure Boot Policy variables can be configured by a physically present user without full authentication.
Restore Factory Keys	Force System to User Mode. Install factory default Secure Boot key databases.
Reset To Setup Mode	Delete all Secure Boot key databases from NVRAM
Key Management	Enables expert users to modify Secure Boot Policy variables without full authentication

## 4.7 Boot Settings



BIOS Setting	Description
Setup Prompt Timeout	Number of seconds to wait for setup activation key. 65535(0xFFFF) means indefinite waiting.
Bootup NumLock State	Selects the keyboard NumLock state.
Quiet Boot	Enables / Disables Quiet Boot option.
Boot mode select	Selects a Boot mode, Legacy / UEFI.
Boot Option Priorities	Sets the system boot order.
UEFI USB Key Drive BBS Priorities	Specifies the Boot Device Priority sequence from available UEFI USB Key Drives.

## 4.8 Save & Exit Settings



BIOS Setting	Description
Save Changes and Exit	Exits system setup after saving the changes.
Discard Changes and Exit	Exits system setup without saving any changes.
Save Changes and Reset	Resets the system after saving the changes.
Discard Changes and Reset	Resets system setup without saving any changes.
Save Changes	Saves changes done so far to any of the setup options.
Discard Changes	Discards changes done so far to any of the setup options.
Restore Defaults	Restores / Loads defaults values for all the setup options.
Save as User Defaults	Saves the changes done so far as User Defaults.
Restore User Defaults	Restores the user defaults to all the setup options.

This page is intentionally left blank.