

# **FWA8708-C FWA8708-H 1U Rackmount Network Appliance**

## **User's Manual**

Version 1.0  
(Dec. 2018)



## **Copyright**

© 2018 IBASE Canada. All rights reserved.

No part of this publication may be reproduced, copied, stored in a retrieval system, translated into any language or transmitted in any form or by any means, electronic, mechanical, photocopying, or otherwise, without the prior written consent of IBASE Technology, Inc. (hereinafter referred to as “IBASE”).

## **Disclaimer**

IBASE reserves the right to make changes and improvements to the products described in this document without prior notice. Every effort has been made to ensure the information in the document is correct; however, IBASE does not guarantee this document is error-free. IBASE assumes no liability for incidental or consequential damages arising from misapplication or inability to use the product or the information contained herein, nor for any infringements of rights of third parties, which may result from its use.

## **Trademarks**

All the trademarks, registrations and brands mentioned herein are used for identification purposes only and may be trademarks and/or registered trademarks of their respective owners.

## Compliance

### CE

This product has passed CE tests for environmental specifications and limits. This product is in accordance with the directives of the Union European (EU). If users modify and/or install other devices in this equipment, the CE conformity declaration may no longer apply.

### FCC

This product has been tested and found to comply with the limits for a Class A device, pursuant to Part 15 of the FCC Rules. These limits are designed to provide reasonable protection against harmful interference in a residential installation. This equipment generates, uses and can radiate radio frequency energy and, if not installed and used in accordance with manufacturer's instructions, may cause harmful interference to radio communications.

### WEEE



This product must not be disposed of as normal household waste, in accordance with the EU directive of for waste electrical and electronic equipment (WEEE - 2012/19/EU). Instead, it should be disposed of by returning it to a municipal recycling collection point. Check local regulations for disposal of electronic products.

### Green IBASE



This product is compliant with the current RoHS restrictions and prohibits use of the following substances in concentrations exceeding 0.1% by weight (1000 ppm) except for cadmium, limited to 0.01% by weight (100 ppm).

- Lead (Pb)
- Mercury (Hg)
- Cadmium (Cd)
- Hexavalent chromium (Cr6+)
- Polybrominated biphenyls (PBB)
- Polybrominated diphenyl ether (PBDE)

# Important Safety Information

Carefully read the precautions before using the device.

## Environmental conditions:

- Lay the device horizontally on a stable and solid surface in case the device may fall, causing serious damage.
- Slots and openings on the chassis are for ventilation. Do not block or cover these openings. Make sure you leave plenty of space around the device for ventilation. NEVER INSERT OBJECTS OF ANY KIND INTO THE VENTILATION OPENINGS.
- Use this product in environments at ambient temperatures 0°C ~ 40°.
- DO NOT LEAVE THIS DEVICE IN AN ENVIRONMENT WHERE THE STORAGE TEMPERATURE MAY GO BELOW -20°C OR ABOVE 70°C. This could damage the device. The device must be used in a controlled environment.

## Care for your new products:

- Before cleaning the device, turn it off and unplug all cables such as power in case a small amount of electrical current may still flow.
- Use neutral cleaning agents or diluted alcohol to clean the device chassis with a cloth. Then wipe the chassis with a dry cloth.
- Vacuum the dust with a computer vacuum cleaner to prevent the air vent or slots from being clogged.



## WARNING

## Attention during use:

- Do not use this product near water.
- Do not spill water or any other liquids on your device.
- Do not place heavy objects on the top of the device.
- Operate this device from the type of power indicated on the marking label. If you are not sure of the type of power available, consult your distributor or local power company.
- Do not walk on the power cord or allow anything to rest on it.
- If you use an extension cord, make sure that the total ampere rating of the product plugged into the extension cord does not exceed its limits.
- When handling processor chips or memory modules, avoid touching their pins or gold fingers. Put modules or peripherals back into antistatic bags when they are not in use or not installed in the chassis.

## Avoid Disassembly

Do not disassemble, repair or make any modification to the device. Disassembly, modification, or any attempt at repair could generate hazards and cause damage to the device, even bodily injury or property damage, and will void any warranty.



## CAUTION

Danger of explosion if internal lithium-ion battery is replaced by an incorrect type. Replace only with the same or equivalent type recommended by the manufacturer. Dispose of used batteries according to the manufacturer's instructions. Under no circumstances should the Lithium battery cell be shorted; otherwise the battery cell may heat up or cause potential burn hazards.

## Warranty Policy

- **Standard products:**

24-month (2-year) warranty from the date of shipment. If the date of shipment cannot be ascertained, the product serial numbers can be used to determine the approximate shipping date.
  - **3<sup>rd</sup>-party parts:**

12-month (1-year) warranty from delivery for the 3<sup>rd</sup>-party parts that are not manufactured by us, such as CPU, memory, HDD, power adapter, panel and touchscreen.
- \* PRODUCTS, HOWEVER, THAT FAILS DUE TO MISUSE, ACCIDENT, IMPROPER INSTALLATION OR UNAUTHORIZED REPAIR SHALL BE TREATED AS OUT OF WARRANTY AND CUSTOMERS SHALL BE BILLED FOR REPAIR AND SHIPPING CHARGES.

## Technical Support & Services

1. If you need any further assistance from your distributor or sales representative, prepare the following information of your product and elaborate upon the problem and contact them or [support@ibt.ca](mailto:support@ibt.ca)
  - Product model name
  - Product serial number
  - Detailed description of the problem
  - The error messages in text or in screenshots if there is any
  - The arrangement of the peripherals
  - Software in use (such as OS and application software, including the version numbers)

# Table of Contents

---

Compliance.....	iii
Important Safety Information .....	iv
<b>WARNING</b> .....	<b>iv</b>
<b>CAUTION</b> .....	<b>v</b>
Warranty Policy .....	v
Technical Support & Services .....	v
<b>Chapter 1 General Information.....</b>	<b>1</b>
1.1 Introduction .....	2
1.2 Features.....	3
1.3 Packing List.....	3
1.4 Optional Accessories .....	4
1.5 Specifications.....	4
1.6 Overview.....	7
1.7 Dimensions .....	9
<b>Chapter 2 Hardware Configuration.....</b>	<b>10</b>
2.1 Installation / Replacement.....	11
2.1.1 Network Module Installation / Removal.....	12
2.1.2 HDD Installation / Removal.....	12
2.1.3 Memory Installation / Replacement.....	14
2.1.4 IPMI Module Installation / Replacement.....	15
2.1.5 Fan Module Installation / Removal.....	16
2.1.6 Redundant Power Supply Unit Installation / Replacement .....	16
2.2 Pinout for Console Port .....	16
2.3 Setting the Jumper .....	17
2.4 Jumper & Connector Locations on Motherboard .....	18
2.5 Jumper Quick Reference.....	20
2.5.1 AT & ATX Mode (JP2).....	20
2.5.2 PEG Configuration (JBAT1, JBAT2).....	21
2.5.3 Clearing CMOS Data (JBAT3).....	22
2.5.4 Clearing ME Register (JBAT4).....	23
2.6 Connectors Quick Reference .....	24
2.6.1 External Power Switch Connector (J2).....	25

2.6.2	USB 2.0 Connector (J15).....	26
2.6.3	PM Bus Port (J20).....	27
2.6.4	System Function Connector (JP3).....	28
2.6.5	Digital I/O Connector (JP4) .....	29
2.6.6	External SATA Power Connector (CN1, CN4, CN5).....	30
2.6.7	LCM Connector (CN7) .....	31
2.6.8	ATX Power Connector (J1, J18).....	32
2.6.9	Fan Connector (FAN_CPU1, FAN1, FAN2, FAN3, FAN4)....	33

**Chapter 3 BIOS Setup ..... 34**

3.1	Introduction .....	35
3.2	BIOS Setup.....	35
3.3	Main Settings .....	36
3.4	Advanced Settings .....	37
3.4.1	CPU Configuration.....	37
3.4.2	Trusted Computing .....	38
3.4.3	SATA Configuration .....	39
3.4.4	Smart Settings.....	39
3.4.5	NCT5523D Super I/O Configuration .....	40
3.4.6	NCT7904D HW Monitor.....	43
3.4.7	LAN Bypass Configuration.....	44
3.4.8	Serial Port Console Redirection.....	45
3.4.9	USB Configuration.....	47
3.5	Security Settings .....	48
3.6	Boot Settings.....	49
3.7	Save & Exit Settings.....	50

**Appendix..... 51**

A.	I/O Port Address Map.....	52
B.	Interrupt Request Lines (IRQ) .....	54
C.	Digital I/O Sample Code.....	57
D.	Watchdog Timer Configuration.....	62



# Chapter 1

## General Information

The information provided in this chapter includes:

- Features
- Packing List
- Optional Accessories
- Specifications
- Overview
- Dimensions

## 1.1 Introduction

FWA8708 series are specifically designed for the network security and management market. There are plenty of applications adopting network security or network management as listed below.

- **FWA8708-C**



- **FWA8708-H**



Network Security Applications:

- Firewall
- Unified Threat Management (UTM)
- Virtual Private Network (VPN)
- Proxy Server
- Caching Server

Network Management Applications:

- Load balancing
- Quality of Service
- Remote Access Service

The FWA networking appliance product line covers the spectrum from offering platforms designed for:

- SOHO
- SMB
- Enterprise

Each product is designed to address the distinctive requirements of its respective market segment from cost effective entry-level solutions to high throughput and performance-bound systems for the enterprise level.

## 1.2 Features

- 8<sup>th</sup> Gen. Intel® Xeon® / Core™ i7/i5/i3 processor with up to 6 cores plus C246 or H310 PCH
- 6 x RJ45 GbE + 2x SFP GbE on board ([SFP for FWA8708-C only](#))
- 4 or 2 x DDR4 DIMM, expandable up to 64 GB (ECC or non-ECC)
- Optional IPMI 2.0 module ([for FWA8708-C only](#))
- Optional NIC slot ([for FWA8708-C only](#))
- 1 x Mini-PCIe and 1 x M.2 M2280 expansion slots

## 1.3 Packing List

Your product package should include the items listed below. If any of the items below is missing, contact the distributor or the dealer from whom you purchased the product.

### Models with a single PSU:

- |                                    |     |
|------------------------------------|-----|
| • FWA8708                          | x 1 |
| • 250W Full Range ATX Power Supply | x 1 |
| • Power Cord (180 cm)              | x 1 |
| • Rack Mount Bracket               | x 2 |

### Models with 1+1 redundant PSU:

- |  |     |
|--|-----|
| • FWA8708                              | x 1 |
| • 300W 1+1 Redundant Power Supply Unit | x 1 |
| • Power Cord (180 cm)                  | x 2 |
| • Rack Mount Bracket                   | x 2 |

## 1.4 Optional Accessories

The following optional accessories are available. Please contact us or your dealer if you need any.

- Console Cable (160 cm, PK1-51)
- IPMI Module (IDN100)
- VGA Cable (40 cm, VGA21A)
- NIC Modules:
  - IBN-R420BN (4 x RJ45 GbE, Non-Bypass)
  - IBN-R420B (4 x RJ45 GbE, 2 Bypass Segment)
  - IBN-R840N (8 x RJ45 GbE, Non-Bypass)
  - IBN-R840 (8 x RJ45 GbE, 4 Bypass Segment)
  - IBN-S400 (4 x GbE SFP, Non-Bypass)
  - IBN-S800 (8 x GbE SFP, Non-Bypass)
  - IBN-P400D (2 x 10GbE SFP+, Non-Bypass)
  - IBN-P400Q (4 x 10GbE SFP+, Non-Bypass)
  - IBN-S420D (2 x GbE SFP, 1 Bypass Segment)
  - IBN-S420Q (4 x GbE SFP, 2 Bypass Segment)
  - IBN-P420D (2 x 10GbE SFP+, 1 Bypass Segment)
  - IBN-P420Q (4 x 10GbE SFP+, 2 Bypass Segment)
  - IBN-F200 (2 x 25GbE SFP+, Non-Bypass)

## 1.5 Specifications

Product Name	FWA8708-C	FWA8708-H
<b>System</b>		
<b>Motherboard</b>	MBN805C	MBN805H
<b>Operating System</b>	<ul style="list-style-type: none"> <li>• Windows 10 (64-bit)</li> <li>• Linux Ubuntu 16.04</li> </ul>	
<b>CPU</b>	8 <sup>th</sup> Gen. Intel® Xeon® / Core™ i7/i5/i3 LGA1151	8 <sup>th</sup> Gen. Intel® Core™ i7/i5/i3 LGA1151
<b>Chipset</b>	Intel® C246 PCH	Intel® H310 PCH
<b>Memory</b>	4 x DDR4 DIMM up to 2666 MHz; max. 64 GB UDIMM (ECC or non-ECC)	2 x DDR4 DIMM up to 2666 MHz; max. 32 GB UDIMM (ECC or non-ECC)
<b>Network</b>	<ul style="list-style-type: none"> <li>• 6 x Intel® I210AT GbE controller</li> <li>• 2 x Intel® I210IS GbE controller</li> </ul>	6 x Intel® I211AT GbE controller

Product Name	FWA8708-C	FWA8708-H
Storage	<ul style="list-style-type: none"> <li>1 x 3.5" or 2 x 2.5" SATA drive bay (Optional)</li> <li>1 x M.2 M2280 slot with PCIe (x4) &amp; SATA signal</li> </ul>	1 x 3.5" or 2 x 2.5" SATA drive bay (Optional)
IPMI	IPMI module compliant with IPMI 2.0 (Optional)	N/A
Super I/O	Nuvoton NCT5523D	
Bypass	2 x segment, LAN3 & LAN4, LAN5 & LAN6	
Power Supply	<ul style="list-style-type: none"> <li><b>Single PSU:</b> Full range 250W ATX power supply unit</li> <li><b>1+1 RPSU:</b> 300W 1+1 redundant power supply unit</li> </ul>	
Power Requirement	100 ~ 240V AC	
BIOS	AMI BIOS	
Watchdog	Watchdog Timer 256 segments, 0, 1, 2...255 sec/min	
Chassis	Steel with textured black paint	
Dimensions (W x H x D)	438 x 44 x 422 mm (17.24" x 1.73" x 16.61")	
Weight	9 kg (19.84 lb)	
Certificate	CE / FCC Class A	
Front I/O Ports		
LCM	1 x LCM 20x2 dots with 4 keypads	
LED	3 x LEDs for power, HDD, status	
Console	1 x Console port	
Management Port (MGMT)	1 x MGMT (LAN1 shared with IPMI NC-SI port)	
Ethernet Port	<ul style="list-style-type: none"> <li>Up to 6 x RJ45 GbE + 2 x SFP LAN ports</li> <li>1 x network module slot for an IBN card, with up to 16 GbE ports in total (Optional)</li> </ul>	Up to 6 x RJ45 GbE LAN ports
GPIO	1 x user self-defined GPIO button	
USB	2 x USB 3.0	
IBN Card	IBN module tray (Optional)	N/A
Rear I/O Ports		
AC Inlet	<ul style="list-style-type: none"> <li><b>Single PSU:</b> 1 x 100 ~ 240V AC Inlet, full range 250W ATX power supply</li> <li><b>1+1 RPSU:</b> 2 x 100 ~ 240V AC Inlet, with 2 hot-swappable 300W power supply modules</li> </ul>	

<b>Product Name</b>	<b>FWA8708-C</b>	<b>FWA8708-H</b>
<b>Display</b>	1 x VGA port (reserved and optional) via the onboard pin header	
<b>Fan</b>	3 x system fans	
<b>Expansion</b>	<ul style="list-style-type: none"> <li>• 2 x PCIe (x8) slot</li> <li>• 1 x Mini-PCIe slot with PCIe &amp; SATA</li> <li>• 1 x M.2 M2280 with PCIe (x4) &amp; SATA</li> </ul>	<ul style="list-style-type: none"> <li>• 1 x PCIe (x8) slot</li> <li>• 1 x Mini-PCIe slot with SATA only</li> </ul>
<b>Environment</b>		
<b>Temperature</b>	<ul style="list-style-type: none"> <li>• <b>Operating:</b> 0 ~ 40 °C (32 ~ 104 °F)</li> <li>• <b>Storage:</b> -20~ 70 °C (-4 ~ 158 °F)</li> </ul>	
<b>Relative Humidity</b>	5 ~ 90% at 45 °C (non-condensing)	
<b>Vibration Protection</b>	<ul style="list-style-type: none"> <li>• <b>Operating:</b> 0.25 Grms / 3 ~ 500 Hz (Z-axis)</li> <li>• <b>Non-operating:</b> 1.0 Grms / 3 ~ 500Hz (Z-axis)</li> </ul>	
<b>Shock Protection</b>	Sawtooth wave 40G (X/Y/Z-axis)	

All specifications are subject to change without prior notice.

## 1.6 Overview

### Front View

- FWA8708-C

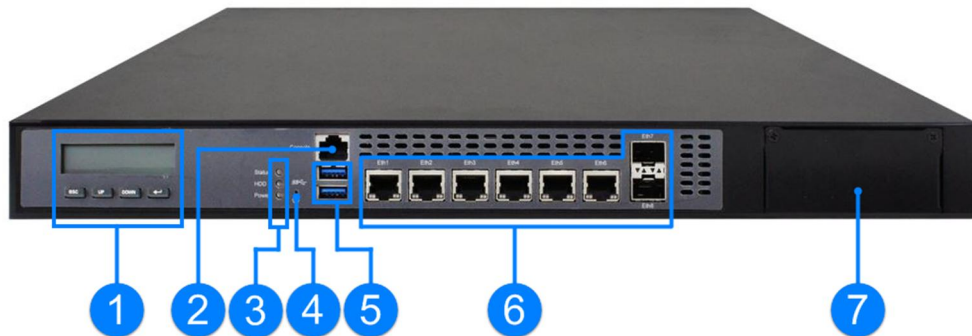

- FWA8708-H

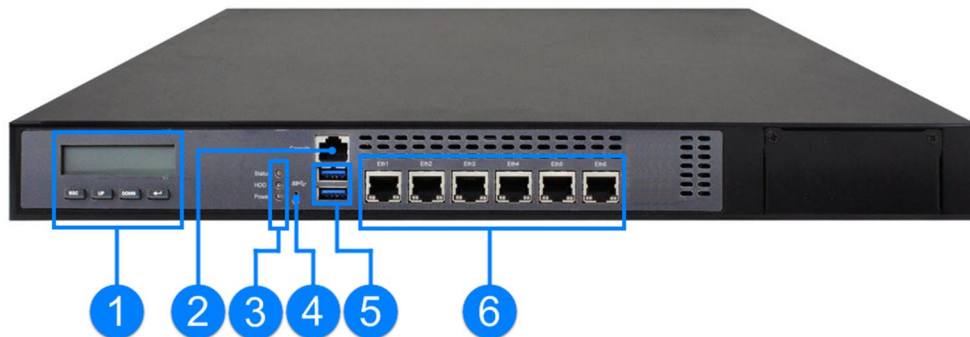

No.	Name	No.	Name
1	LCM Display with 4 buttons	5	USB 3.0 Ports
2	Console Port	6	GbE LAN Ports
3	LED Indicators (From top to bottom: Status, HDD, Power)	7	Reserved Area for IBN module (for <b>FWA8708-C</b> only)
4	User Self-Defined GPIO Button		

## Rear View

- **Single Power Supply Unit**

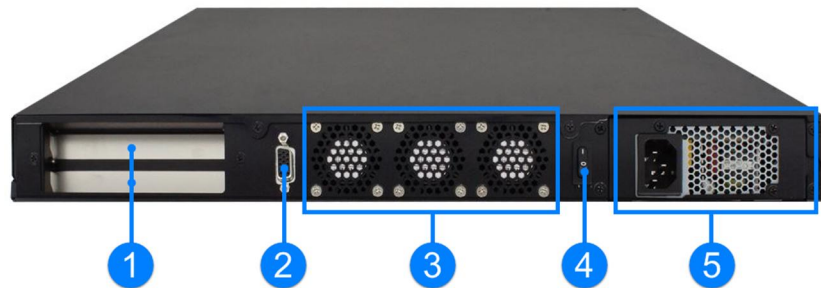

- **Redundant Power Supply Unit**

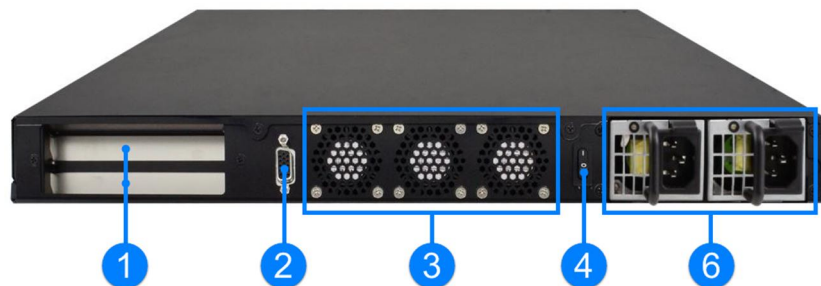

No.	Name	No.	Name
1	PCIe (x8) Expansion Card Slot	4	Power Switch
2	VGA Port (via an onboard pin-header or via the optional IPMI module)	5	Single Power Supply Unit
3	System Fan Modules	6	Redundant Power Supply

## Oblique View

- **FWA8708-C**



- **FWA8708-H**



## 1.7 Dimensions

Unit: mm

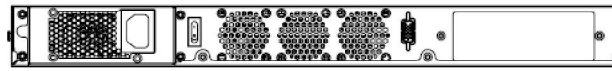

Single PSU

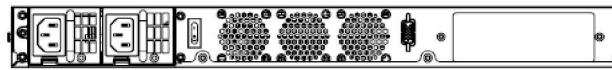

1-1 Redundant PSU

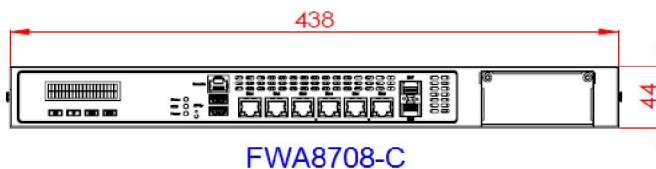
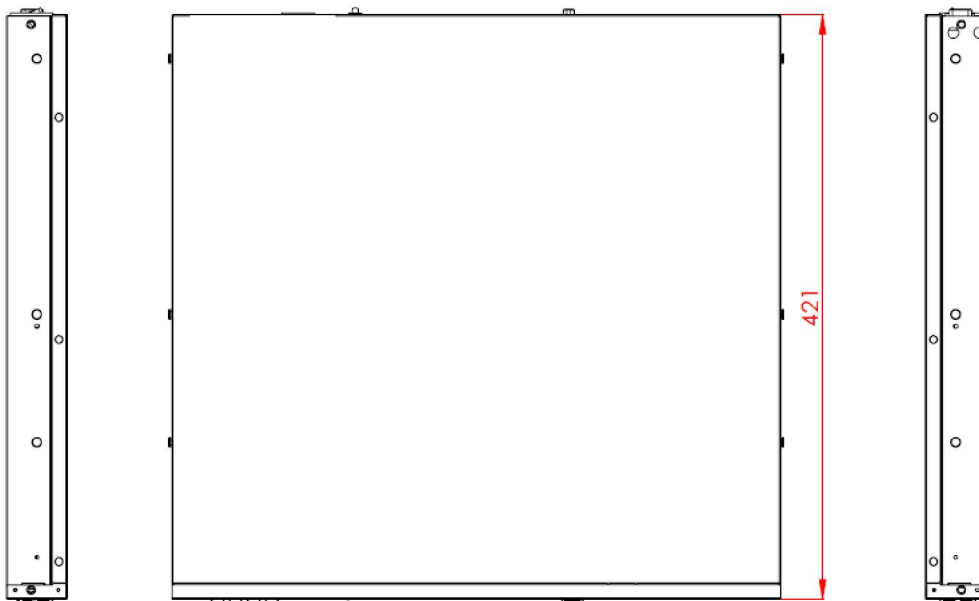

FWA8708-C

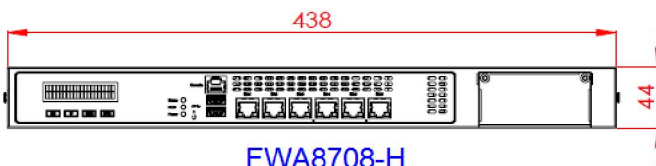

FWA8708-H

## **Chapter 2**

# **Hardware Configuration**

The information provided in this chapter includes:

- Installation / Replacement
- Information and locations of connectors

## 2.1 Installation / Replacement

For the hot-swappable HDD or the IBN Network Interface Modules installations, you can directly install without remove the device cover.

For the memory, M.2, PCIe expansion card or the optional IPMI module, you need to remove 8 screws as shown below to pull out the lid.

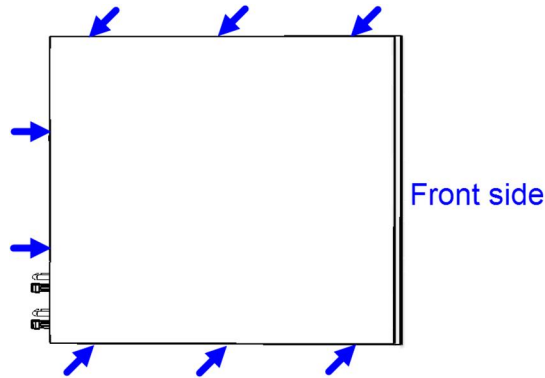

### Configuration inside:

Areas B allows for optional IBN modules, two 2.5" or one 3.5" HDD/SSD. Area A allows for optional two 2.5" or one 3.5" HDD/SSD, or for expansion cards.

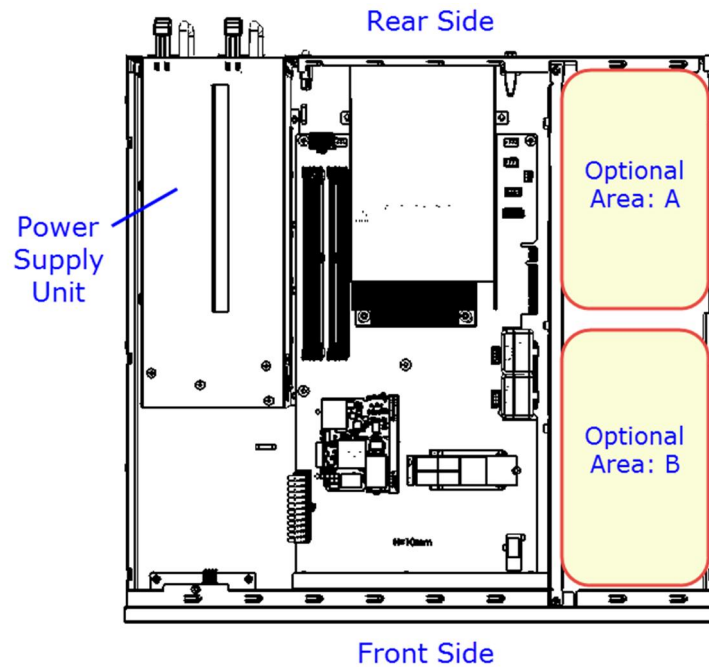

## 2.1.1 Network Module Installation / Removal

---

**Note:** IBN module is purchasable and applicable for FWA8708-C only.

---

Release two screws of a network module and pull it out carefully as shown below for replacement and installation.

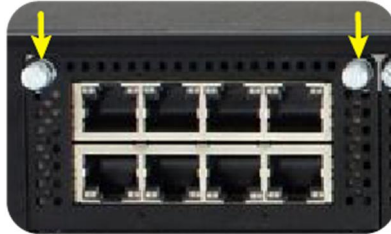

## 2.1.2 HDD Installation / Removal

After you remove the device cover, you can see the optional areas A and B as shown below allowing for optional HDD/SSD and expansion cards installation. If you need to install or replace an HDD/SSD, follow the instructions below for installation.

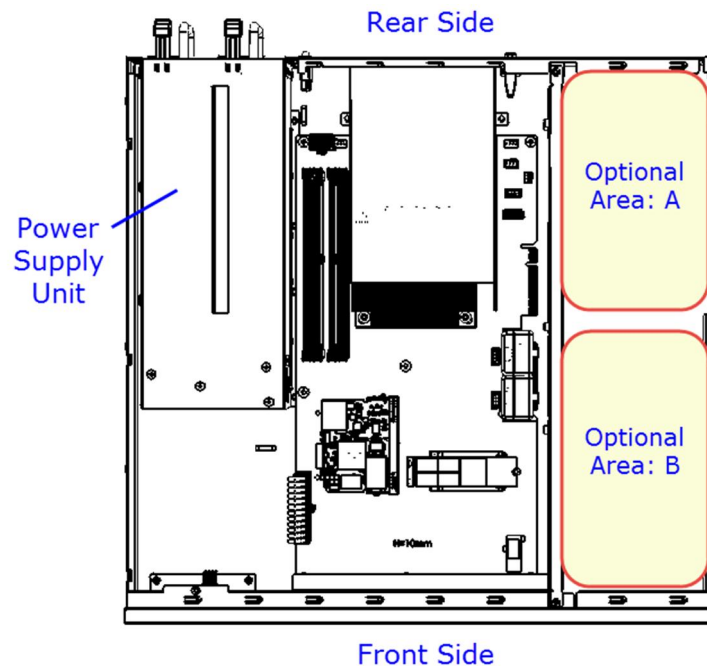

1. Remove 4 screws to loose each 3.5" or 2.5" HDD/SSD tray from the bottom of the device.

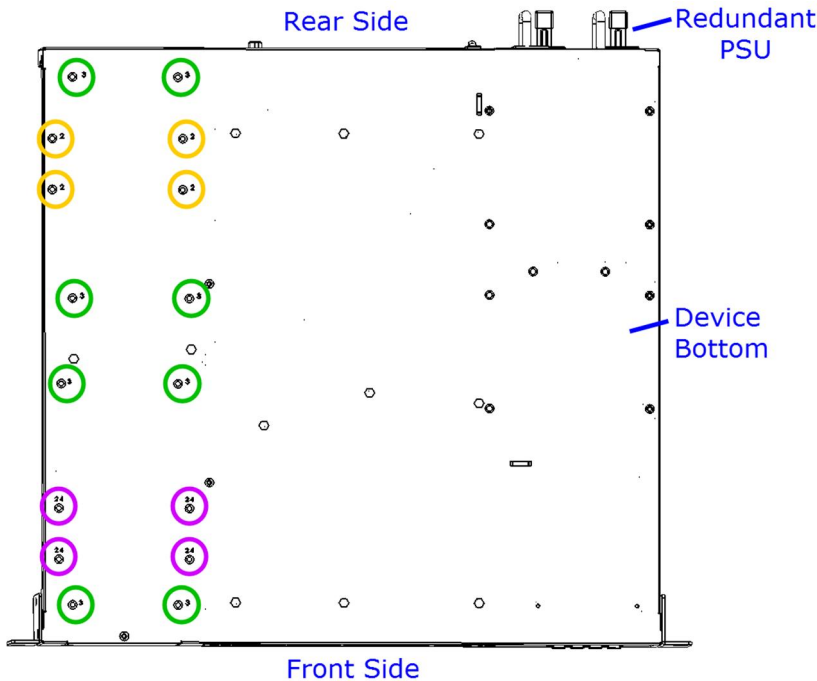

- For 3.5" HDD/SSD
- For 2.5" HDD/SSD
- For 2.5" HDD/SSD & IBN rail bracket

2. Unplug the SATA power and data cable. Remove 4 screws for each 3.5" or 2.5" HDD/SSD to free up the HDD/SSD from the tray.

**3.5" HDD/SSD:**

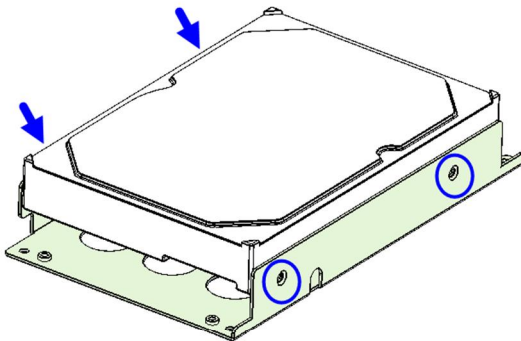

**2.5" HDD/SSD:**

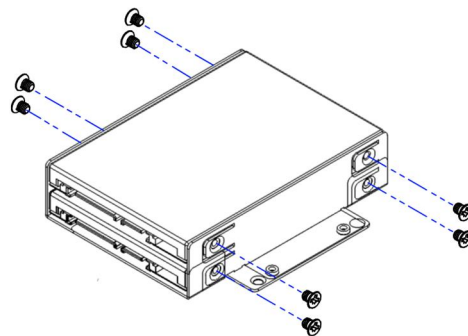

3. Take out the HDD and install a new one onto the tray. Fasten 4 screws back for each HDD.
4. Secure the tray with HDD from the bottom of the device. Note the screw holes for different sizes of HDD/SSD as illustrated below.

### 2.1.3 Memory Installation / Replacement

If you need to install or replace a memory module, follow the instructions below for installation after you remove the device cover.

1. Press the ejector tab of the memory slot down and outwards with your fingertips.

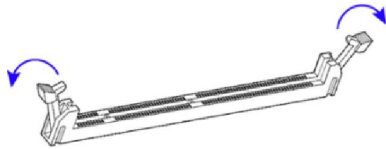

2. Hold the memory module and align the key of the module with that on the memory slot.
3. Gently push the module in an upright position until the ejector tabs of the memory slot close to hold the module in place when the module touches the bottom of the slot.

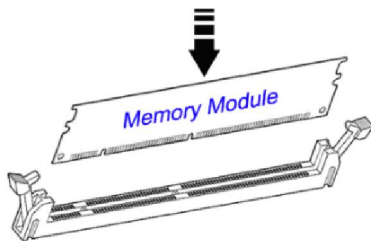

To remove the module, press the ejector tabs outwards with your fingertips to eject the module.

### 2.1.4 IPMI Module Installation / Replacement

If you need to install an IPMI module, remove the system lid firstly and then follow the instructions below.

---

**Note:** IPMI module is optionally purchasable and applicable for FWA8708-C only.

---

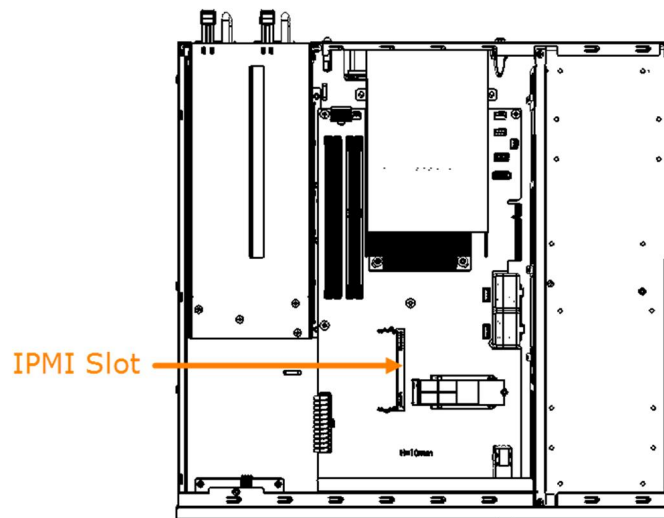

1. Locate the IPMI slot and align the key of the module with that on the slot.
1. Insert the module slantwise and gently push the module straight down until the clips of the slot close to hold the module in place when the module touches the bottom of the slot.

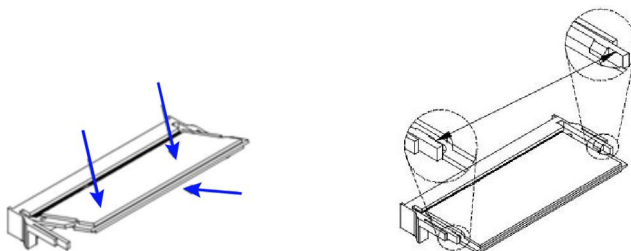

To remove the module, press the clips outwards with your thumb and index finger of both hands.

## 2.1.5 Fan Module Installation / Removal

If you need to install or replace a fan module, after removing the device cover, release 4 screws for each fan module on the rear side of the device, take out the fan, replace with a new one, and tighten these screws.

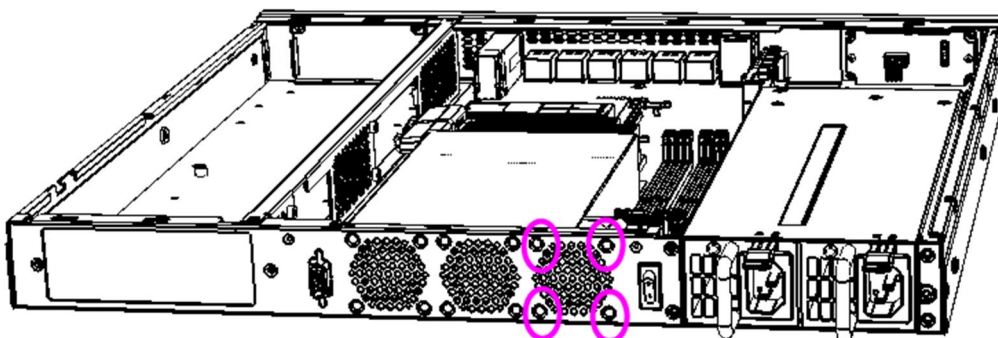

## 2.1.6 Redundant Power Supply Unit Installation / Replacement

If you need to install or replace a redundant power supply unit, push the latch downwards, grasp the handle, pull the PSU out carefully and replace with a new one.

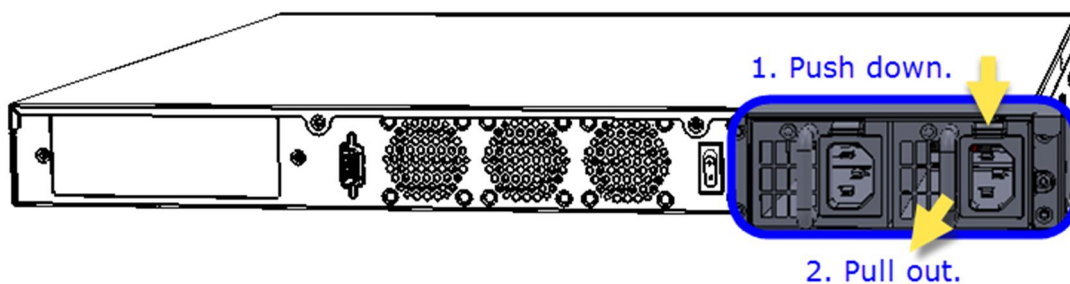

## 2.2 Pinout for Console Port

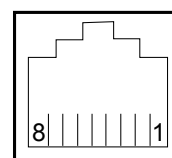

Pin	Signal Name	Pin	Signal Name
1	RTS	5	Ground
2	DTR	6	RXD
3	TXD	7	DSR
4	Ground	8	CTS

### 2.3 Setting the Jumper

Set up and configure your system by using jumpers for various settings and features according to your needs and applications. Contact your supplier if you have doubts about the best configuration for your use.

Jumpers are short-length conductors consisting of several metal pins with a non-conductive base mounted on the circuit board. Jumper caps are used to have the functions and features enabled or disabled. If a jumper has 3 pins, you can connect either PIN1 to PIN2 or PIN2 to PIN3 by shorting.

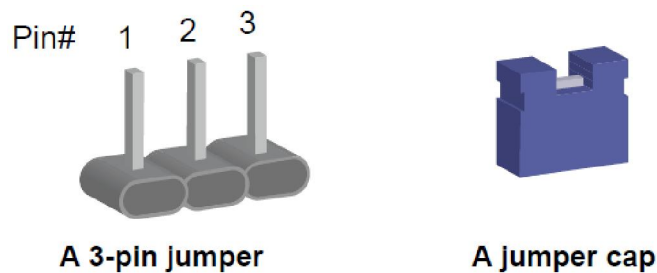

Refer to the illustration below to set jumpers.

Pin closed	Oblique view	Schematic illustration in the manual
Open		
1-2		
2-3		

When two pins of a jumper are encased in a jumper cap, this jumper is **closed**, i.e. turned **On**.

When a jumper cap is removed from two jumper pins, this jumper is **open**, i.e. turned **Off**.





## 2.5 Jumper Quick Reference

Function	Connector Name	Page
AT & ATX Mode Selection	JP2	20
PEG Configuration	JBAT1, JBAT2	21
Clearing CMOS Data	JBAT3	22
Clearing ME Register	JBAT4	23
Factory Use Only	JP1, JBMC1, JBMC2	--

**Note:** The following motherboard drawings in this section are illustrated by the example of **MBN805C**.

### 2.5.1 AT & ATX Mode (JP2)

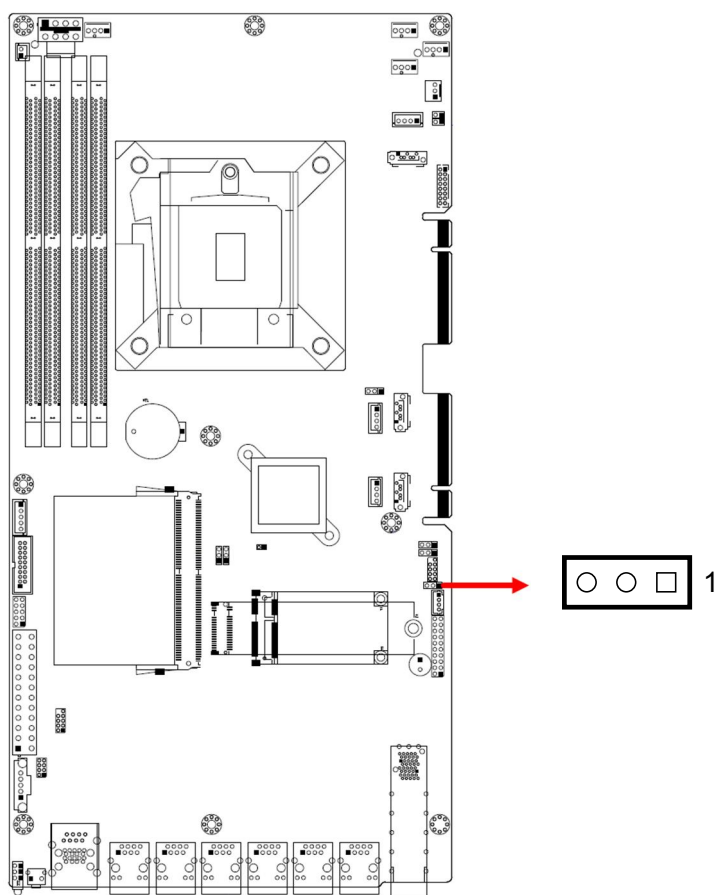





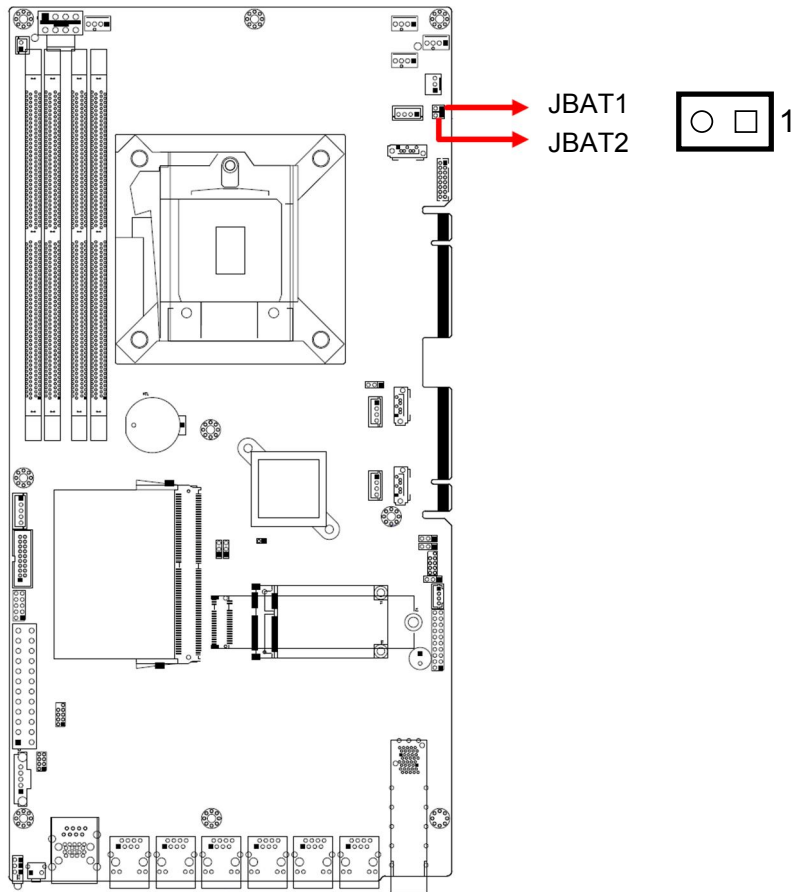



Function	Pin closed	Illustration
AT Mode (Default)	1-2	1
ATX Mode	2-3	1

### 2.5.2 PEG Configuration (JBAT1, JBAT2)





The PEG bifurcation is only configurable for FWA8708-C.  
 1 x PCIe (x16) is always used for FWA8708-H.

Function	Pin closed	Illustration
1 x PCIe (x16)	<b>JBAT1:</b> Open	 1
	<b>JBAT2:</b> Open	 1
2 x PCIe (x8)	<b>JBAT1:</b> Close	 1
	<b>JBAT2:</b> Open	 1
RSVD	<b>JBAT1:</b> Open	 1
	<b>JBAT2:</b> Close	 1
PCIe (x8), PCIe (x4), PCIe (x4) (Default)	<b>JBAT1:</b> Close	 1
	<b>JBAT2:</b> Close	 1

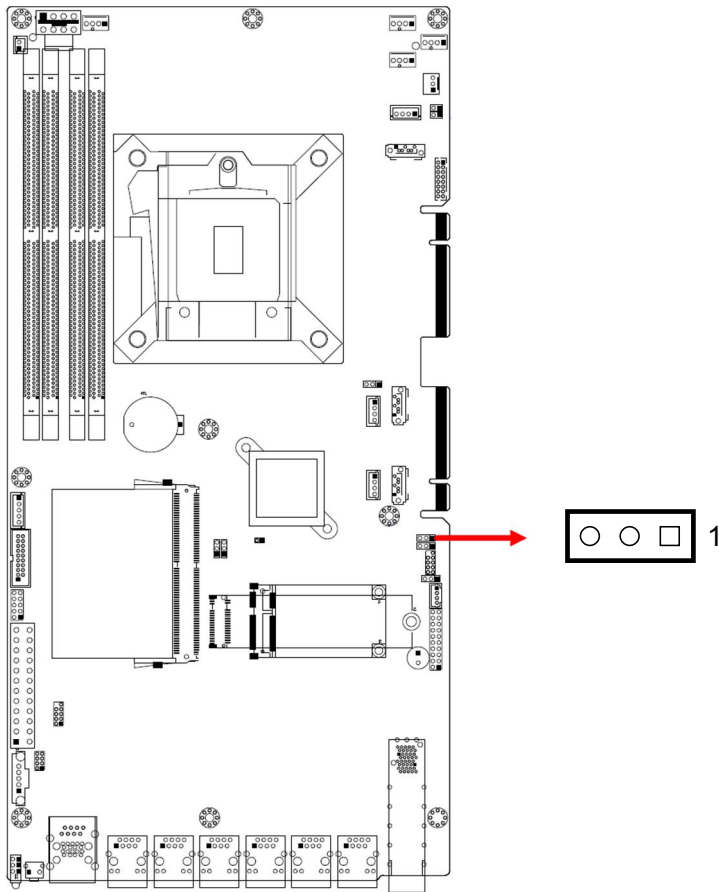
## 2.5.3 Clearing CMOS Data (JBAT3)



Function	Pin closed	Illustration
Normal (Default)	1-2	 1
Clearing CMOS	2-3	 1

### 2.5.4 Clearing ME Register (JBAT4)

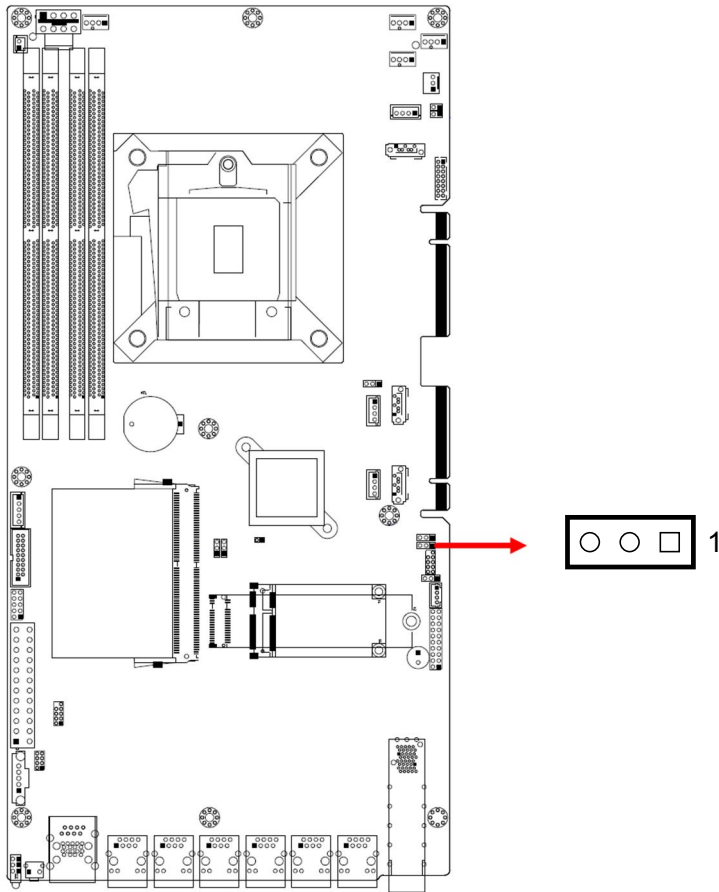

Function	Pin closed	Illustration
Normal (Default)	1-2	1
Clearing ME Register	2-3	1

## 2.6 Connectors Quick Reference

Function	Connector Name	Page
External Power Switch Connector	J2	25
USB 2.0 Connector	J15	26
PM Bus Port <sup>[1]</sup>	J20	27
System Function Connector	JP3	28
Digital I/O Connector	JP4	29
External SATA Power Connector	CN1, CN4, CN5	30
LCM Connector	CN7	31
ATX Power Connector	J1, J18	32
Fan Connector	FAN_CPU1, FAN1, FAN2, FAN3, FAN4	33
Console & Double Stack USB 3.0 Connector	CN9	--
External VGA Connector	J3	--
USB 3.0 Port	J10	--
DDR4 UDIMM Slot	<b>FWA8708-C:</b> J4, J5, J6, J7 <b>FWA8708-H:</b> J5, J7	--
IPMI Slot <sup>[2]</sup>	J12	--
Mini-PCIe Slot	J16	--
M.2 M2280 Slot <sup>[1]</sup>	J17	--
Fiber LAN Connector <sup>[1]</sup>	CN8	--
GbE LAN Port	CN10, CN11, CN12, CN13, CN14, CN15	--
SATA III Port	CN2, CN3, CN6	--
PCIe Gold Finger	<b>Standard:</b> PCIE2 (with x8 signal) <b>For IBN Card only:</b> PCIE1 (with x8 / x4 / x4 signal)	--
Factory Use Only	J8, J11, J14, J19	--

[1]: Available only for FWA8708-C.

[2]: Optionally purchasable for FWA8708-C.

The following motherboard drawings in this section are illustrated by the example of MBN805C.

**2.6.1 External Power Switch Connector (J2)**

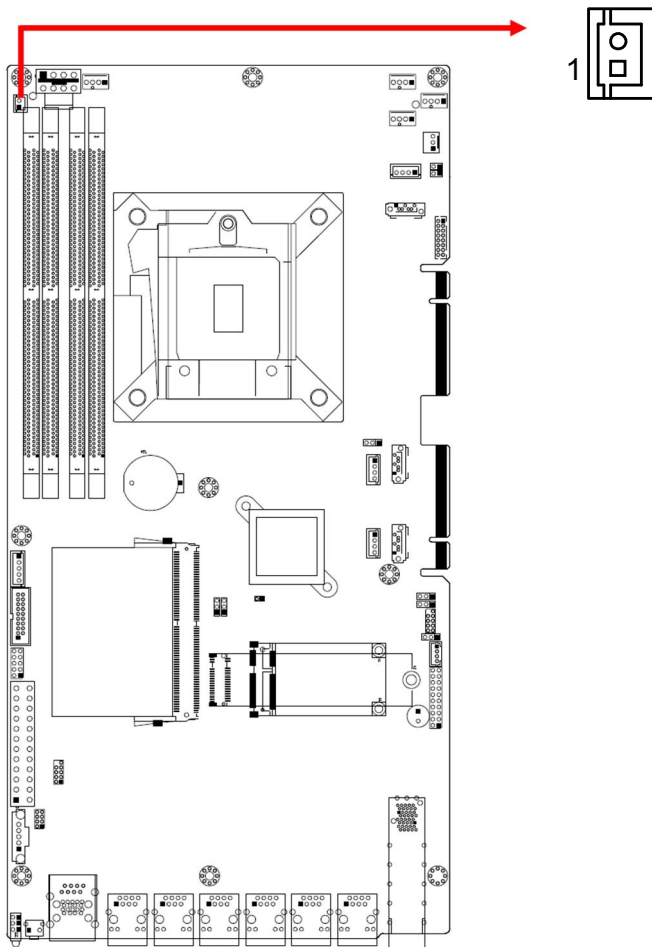

Pin	Signal Name	Pin	Signal Name
1	ATX_PSON#_EN	2	Ground

## 2.6.2 USB 2.0 Connector (J15)

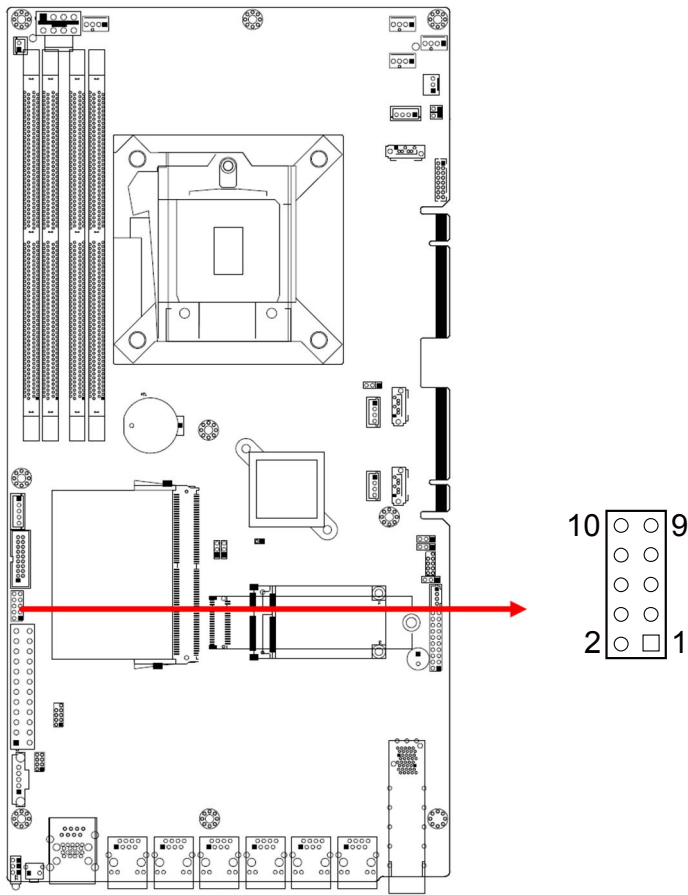

Pin	Signal Name	Pin	Signal Name
1	5VDUAL	2	5VDAUL
3	USB_PN8	4	USB_PN9
5	USB_PP8	6	USB_PP9
7	Ground	8	Ground
9	NC	10	NC

### 2.6.3 PM Bus Port (J20)

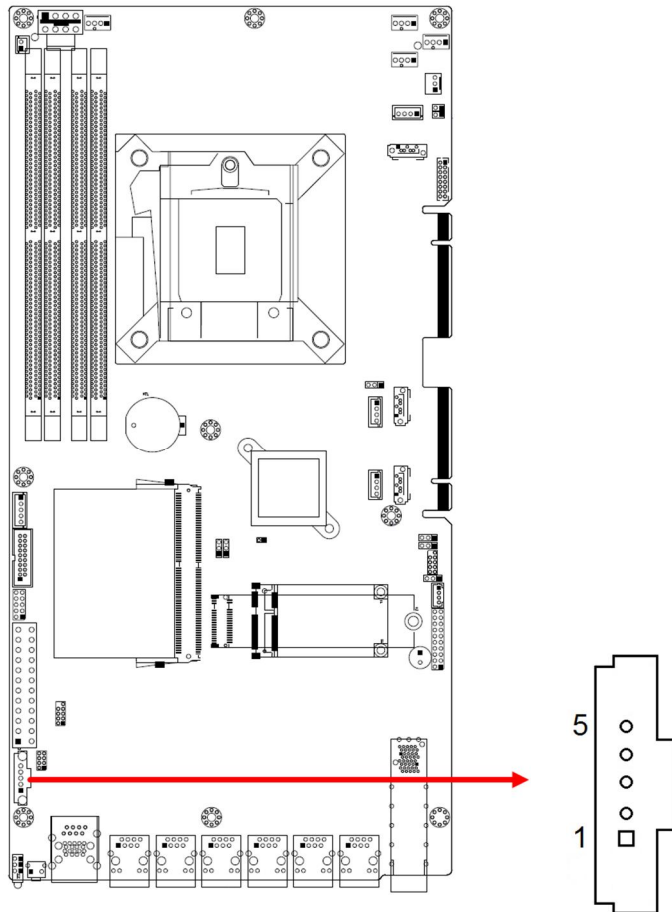

The PM Bus port J20 is only available for FWA8708-C.

Pin	Signal Name	Pin	Signal Name
1	SMB_PWR_5VDUAL_CLK	4	Ground
2	SMB_PWR_5VDUAL_DAT	5	VCC3_3
3	PL_SMBAlert		

## 2.6.4 System Function Connector (JP3)

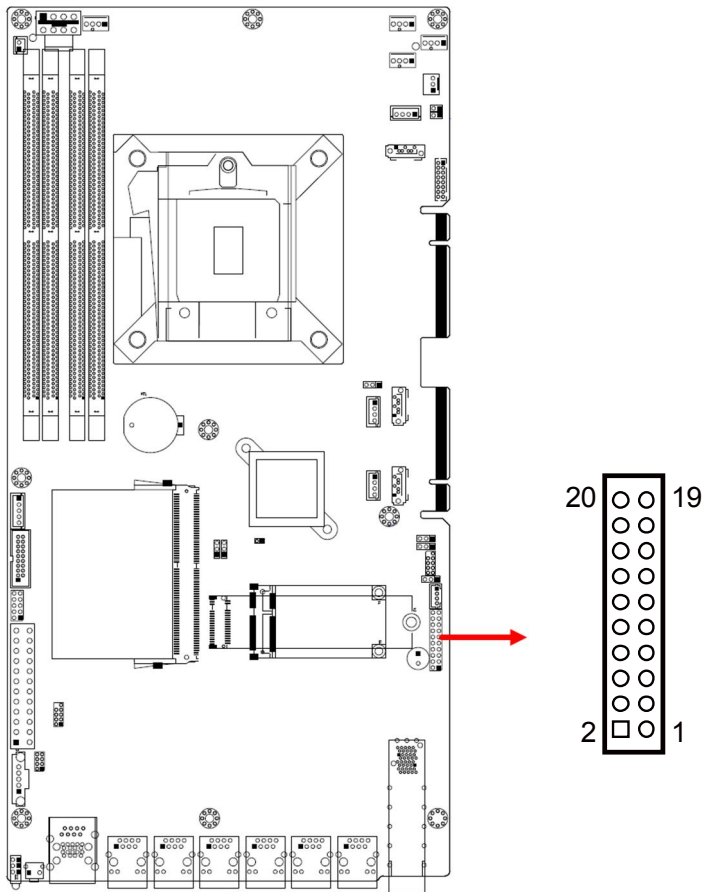

Pin	Signal Name	Pin	Signal Name
1	VCC5	2	Speaker
3	NC	4	NC
5	Ground	6	Ground
7	NC	8	VCC5
9	5VDUAL	10	BYPASSLED0-
11	5VDUAL	12	BYPASSLED1-
13	Ground	14	ATXPWR_BTN#
15	NC	16	NC
17	Ground	18	FRST_OUT
19	VCC3_3	20	-HDD_LED

### 2.6.5 Digital I/O Connector (JP4)

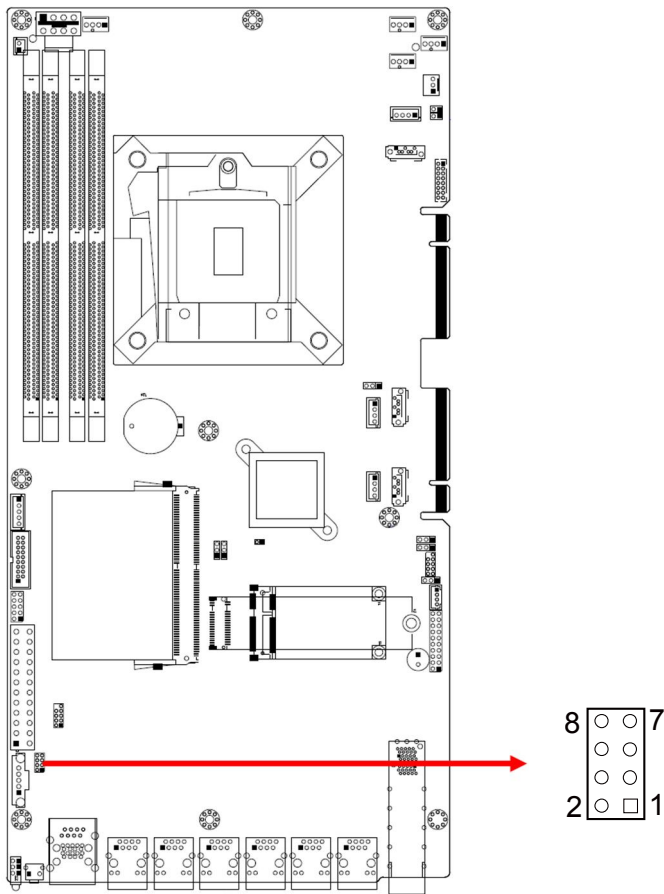

Pin	Signal Name	Pin	Signal Name
1	Ground	2	VCC5
3	INT0_SIOGP22	4	INT0_SIOGP25
5	INT0_SIOGP23	6	INT0_SIOGP26
7	INT0_SIOGP24	8	INT0_SIOGP27

## 2.6.6 External SATA Power Connector (CN1, CN4, CN5)

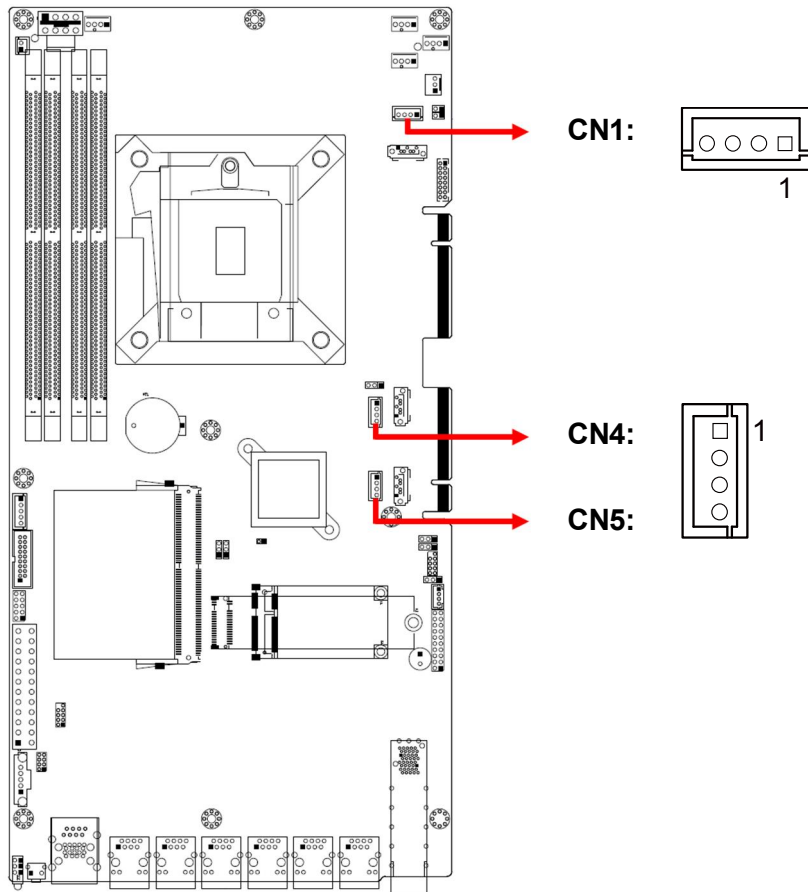

Pin	Signal Name	Pin	Signal Name
1	VCC5	3	Ground
2	Ground	4	VCC12

### 2.6.7 LCM Connector (CN7)

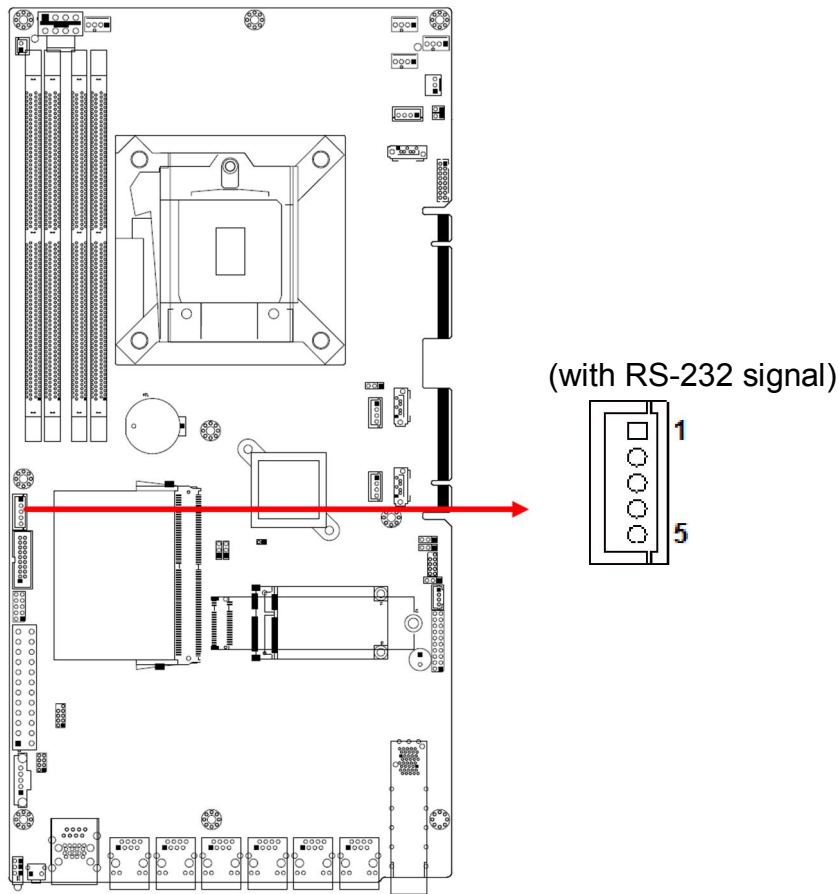

Pin	Signal Name	Pin	Signal Name
1	LCM_RD1	4	VCC5
2	LCM_TD1	5	NC
3	Ground		

## 2.6.8 ATX Power Connector (J1, J18)

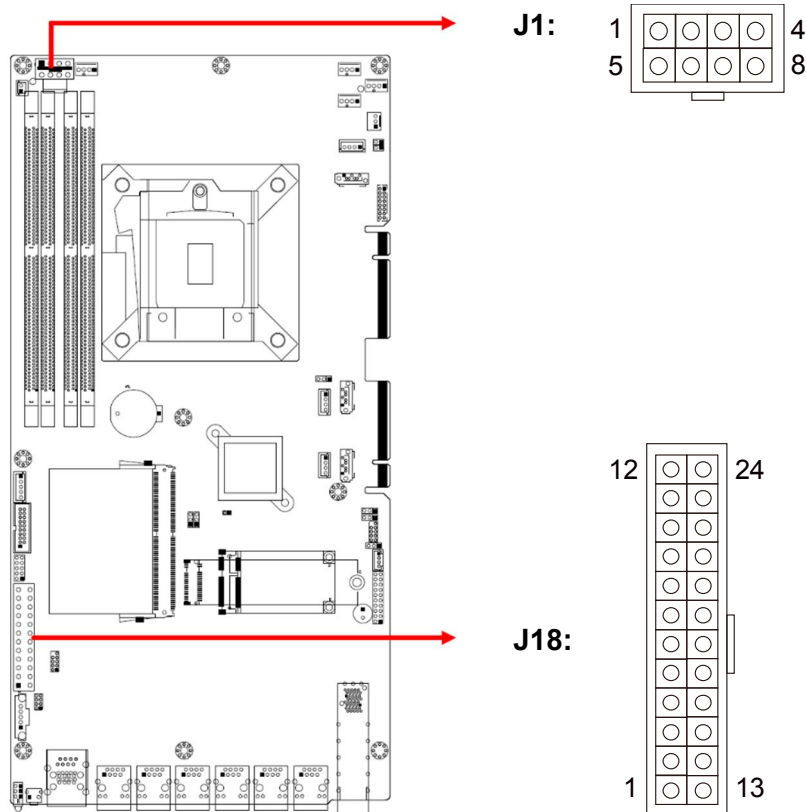

### J1:

Pin	Assignment	Pin	Assignment
1	Ground	5	+12V
2	Ground	6	+12V
3	Ground	7	+12V
4	Ground	8	+12V

### J18:

Pin	Assignment	Pin	Assignment
1	3.3V	13	3.3V
2	3.3V	14	-12V
3	Ground	15	Ground
4	+5V	16	PS-ON
5	Ground	17	Ground
6	+5V	18	Ground
7	Ground	19	Ground
8	Power good	20	-5V
9	5VSB	21	+5V
10	+12V	22	+5V
11	+12V	23	+5V
12	+3.3V	24	Ground

### 2.6.9 Fan Connector (FAN\_CPU1, FAN1, FAN2, FAN3, FAN4)

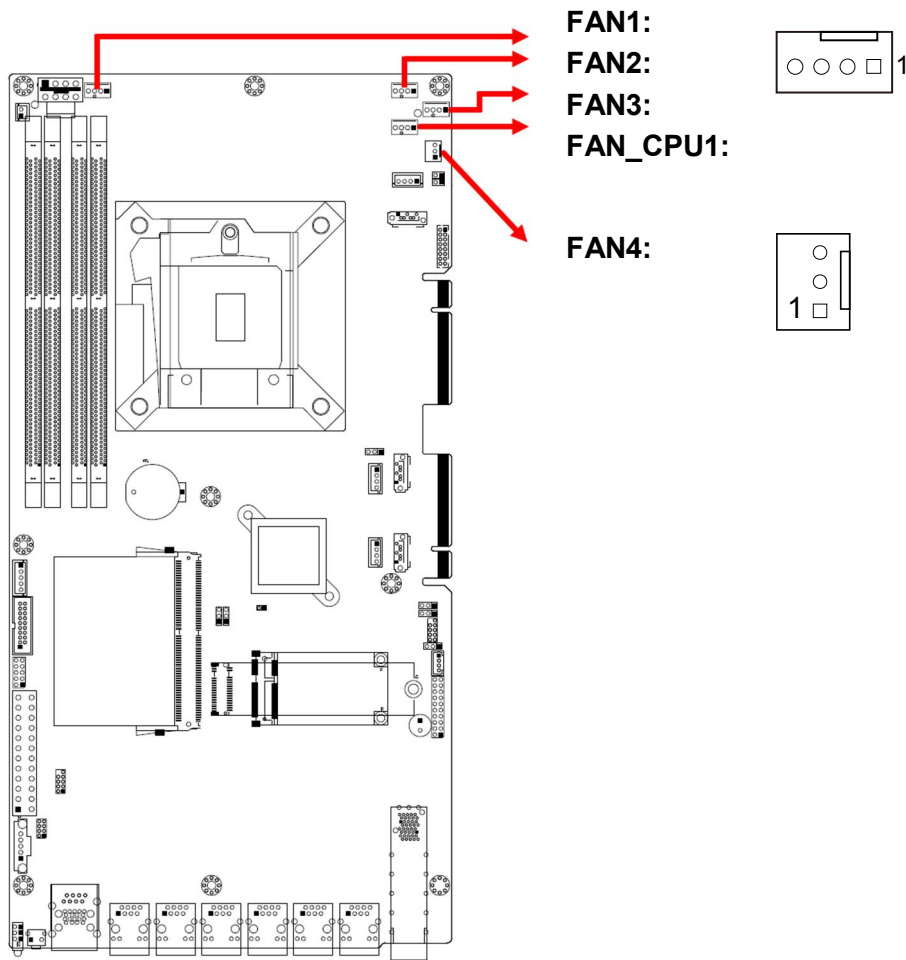

#### CPU\_FAN, FAN1, FAN2, FAN3:

Pin	Assignment	Pin	Assignment
1	Ground	3	FAN_TACH
2	VCC12	4	FAN_PWM

#### FAN4:

Pin	Assignment	Pin	Assignment
1	Ground	3	FAN_TACH
2	VCC12		

## Chapter 3

# BIOS Setup

This chapter describes the different settings available in the AMI BIOS that comes with the board. The topics covered in this chapter are as follows:

- Main Settings
- Advanced Settings
- Chipset Settings
- Security Settings
- Boot Settings
- Save & Exit

### 3.1 Introduction

The BIOS (Basic Input/Output System) installed in the ROM of your computer system supports Intel® processors. The BIOS provides critical low-level support for standard devices such as disk drives, serial ports and parallel ports. It also provides password protection as well as special support for detailed fine-tuning of the chipset controlling the entire system.

### 3.2 BIOS Setup

The BIOS provides a Setup utility program for specifying the system configurations and settings. The BIOS ROM of the system stores the Setup utility. When you turn on the computer, the BIOS is immediately activated. Press the <Del> key immediately allows you to enter the Setup utility. If you are a little bit late pressing the <Del> key, POST (Power On Self Test) will continue with its test routines, thus preventing you from invoking the Setup.

If you still need to enter Setup, restart the system by pressing the "Reset" button or simultaneously pressing the <Ctrl>, <Alt> and <Delete> keys. You can also restart by turning the system Off and back On again.

The following message will appear on the screen:

```
Press <DEL> to Enter Setup
```

In general, press the arrow keys to highlight items, <Enter> to select, the <PgUp> and <PgDn> keys to change entries, <F1> for help, and <Esc> to quit.

When you enter the BIOS Setup utility, the *Main Menu* screen will appear on the screen. The Main Menu allows you to select from various setup functions and exit choices.

---

**Warning:** It is strongly recommended that you avoid making any changes to the chipset defaults.

These defaults have been carefully chosen by both AMI and your system manufacturer to provide the absolute maximum performance and reliability. Changing the defaults could make the system unstable and crash in some cases.

---

### 3.3 Main Settings

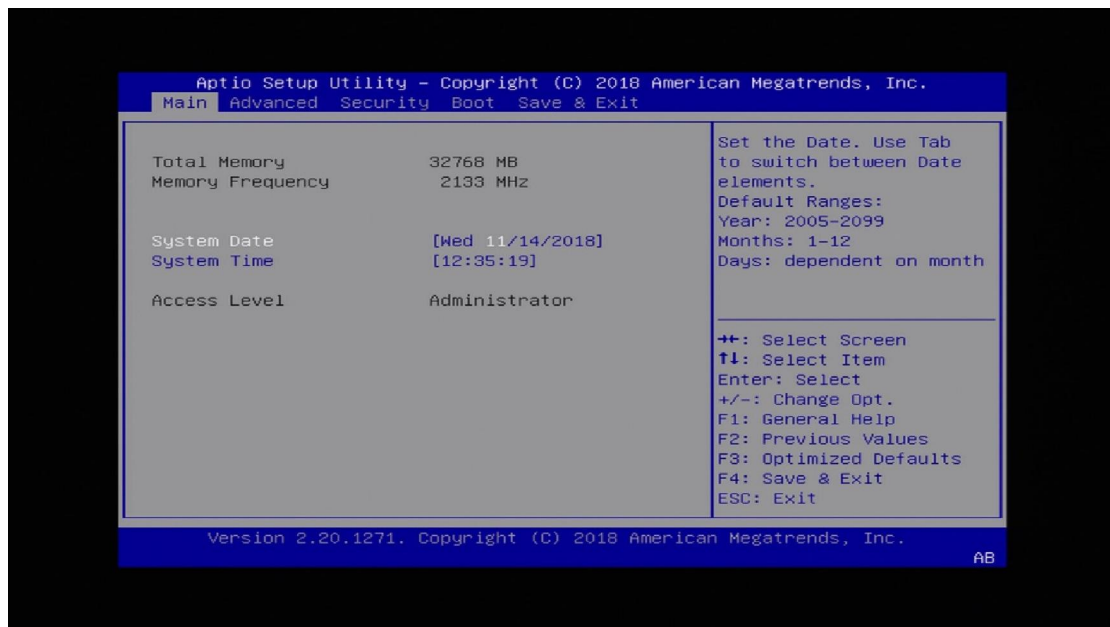

BIOS Setting	Description
System Date	Sets the date. Use the <Tab> key to switch between the data elements.
System Time	Set the time. Use the <Tab> key to switch between the data elements.

### 3.4 Advanced Settings

This section allows you to configure, improve your system and allows you to set up some system features according to your preference.

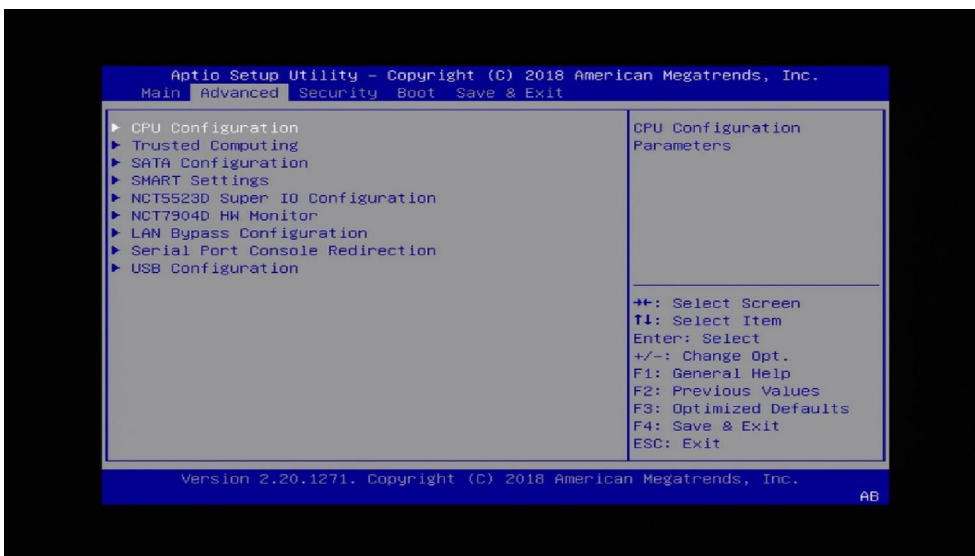

#### 3.4.1 CPU Configuration

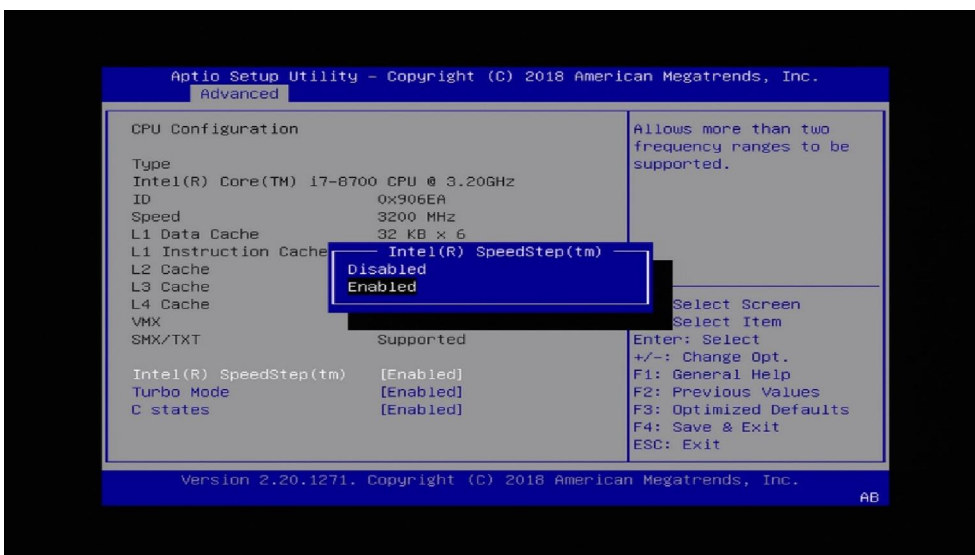

BIOS Setting	Description
Intel(R) SpeedStep(tm)	Allows more than two frequency ranges to be supported.
Turbo Mode	Enables / Disables processor Turbo Mode (requires Intel Speed Step or Intel Speed Shift to be available and enabled).
C states	Enables / Disables CPU power management. Allows CPU to go to C states when it's not 100% utilized.

## 3.4.2 Trusted Computing

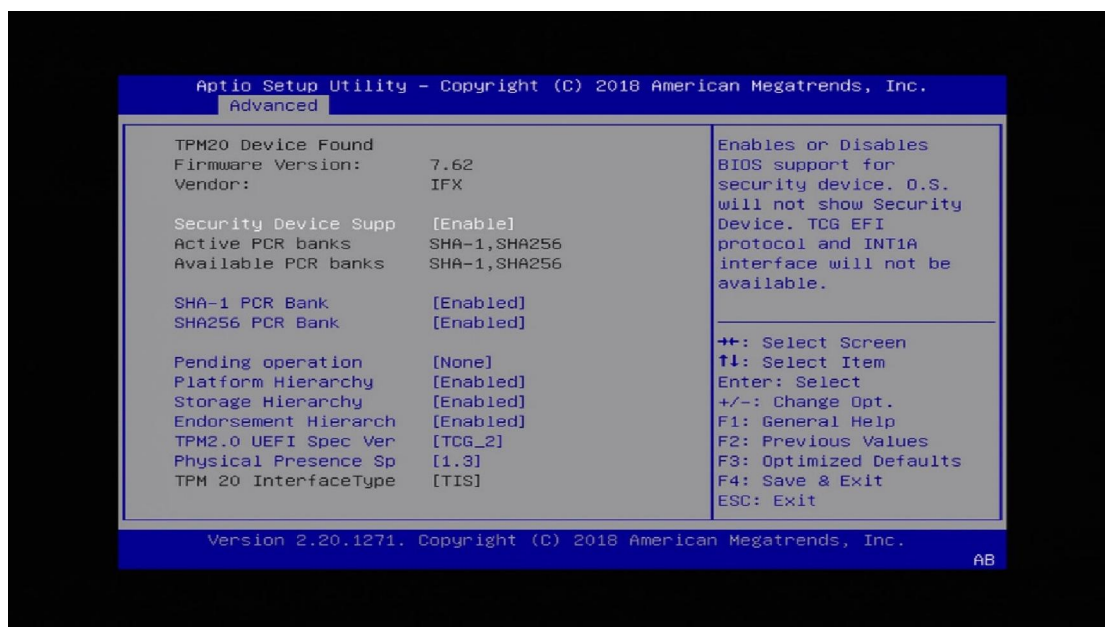

BIOS Setting	Description
Security Device Support	Enables / Disables BIOS support for security device. The operating system will not show the security device. TCG EFI protocol and INT1A interface will not be available.
SHA-1 PCR Bank	Enables / Disables SHA-1 PCR Bank.
SHA256 PCR Bank	Enables / Disables SHA256 PCR Bank.
Pending operation	Schedule an operation for the security device. <b>Note:</b> Your computer will reboot during restart in order to change the state of security device. Options: None, TPM Clear
Platform Hierarchy	Enables / Disables Platform Hierarchy.
Storage Hierarchy	Enables / Disables Storage Hierarchy.
Endorsement Hierarchy	Enables / Disables Endorsement Hierarchy.
TPM 2.0 UEFI Spec Version	Allows you to select the TCG2 spec version support. TCG_1_2: the compatible mode for Windows 10 & 8. TCG_2: Support new TCG2 protocol and event.
Physical Presence Spec	Selects a version of PPI spec version 1.2 or 1.3 to tell OS to support it. <b>Note:</b> Some HCT tests might not support 1.3.

### 3.4.3 SATA Configuration

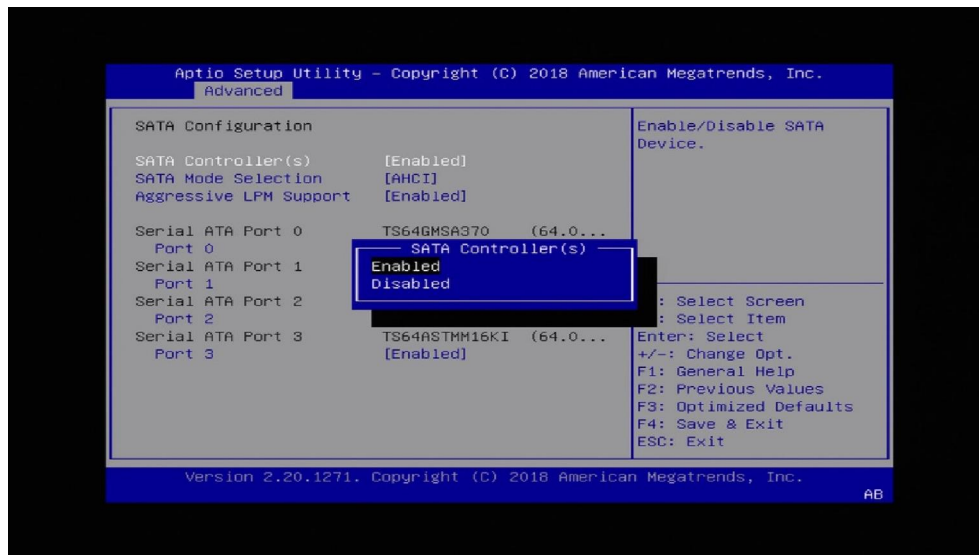

BIOS Setting	Description
SATA Controller(s)	Enables / Disables SATA device.
SATA Mode Selection	Determines how SATA controller(s) operate. This PCH SKU doesn't support RST feature.
Aggressive LPM Support	Enables PCH to aggressively enter link power state.
Serial ATA Port 0/1/2/3	Enables / Disables a Serial ATA port.

### 3.4.4 Smart Settings

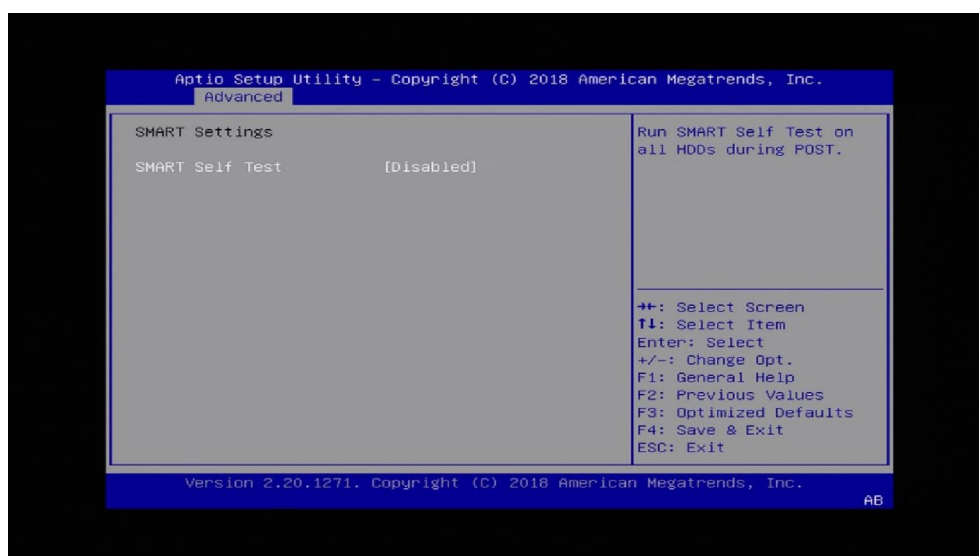

BIOS Setting	Description
Smart Self Test	Run Smart Self Test on all HDDs during POST.

### 3.4.5 NCT5523D Super I/O Configuration

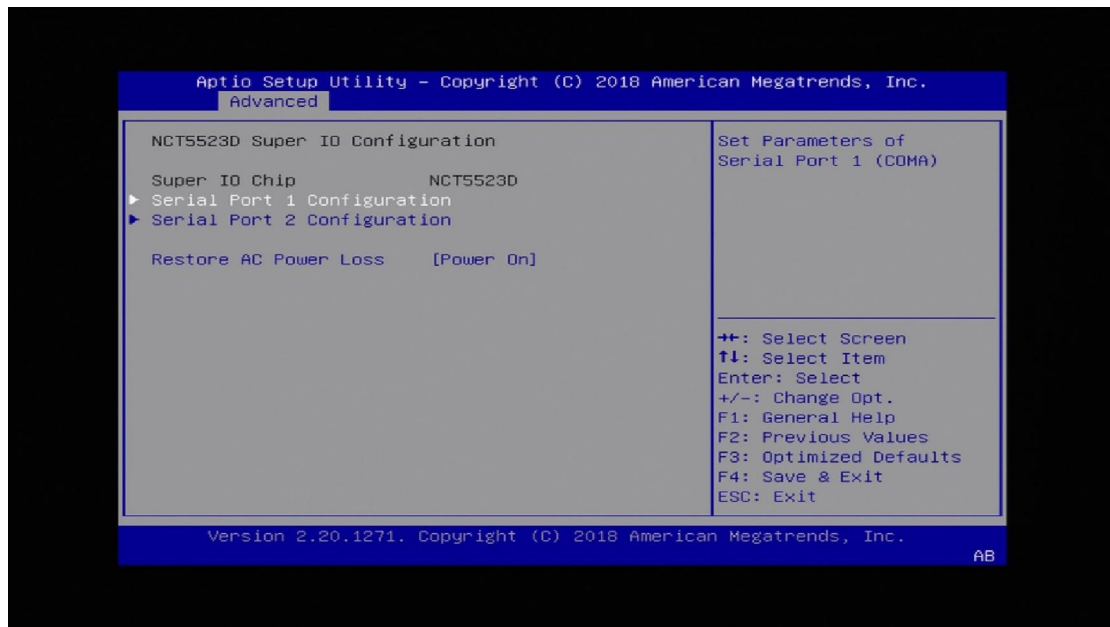

BIOS Setting	Description
Serial Ports Configuration	Sets Parameters of Serial Ports. You can enable / disable the serial port and select an optimal settings for the Super IO device.
Restore AC Power Loss	Select AC power state when power is re-applied after a power failure. Options: Power Off, Power On, Last State

### 3.4.5.1. Serial Port 1 Configuration

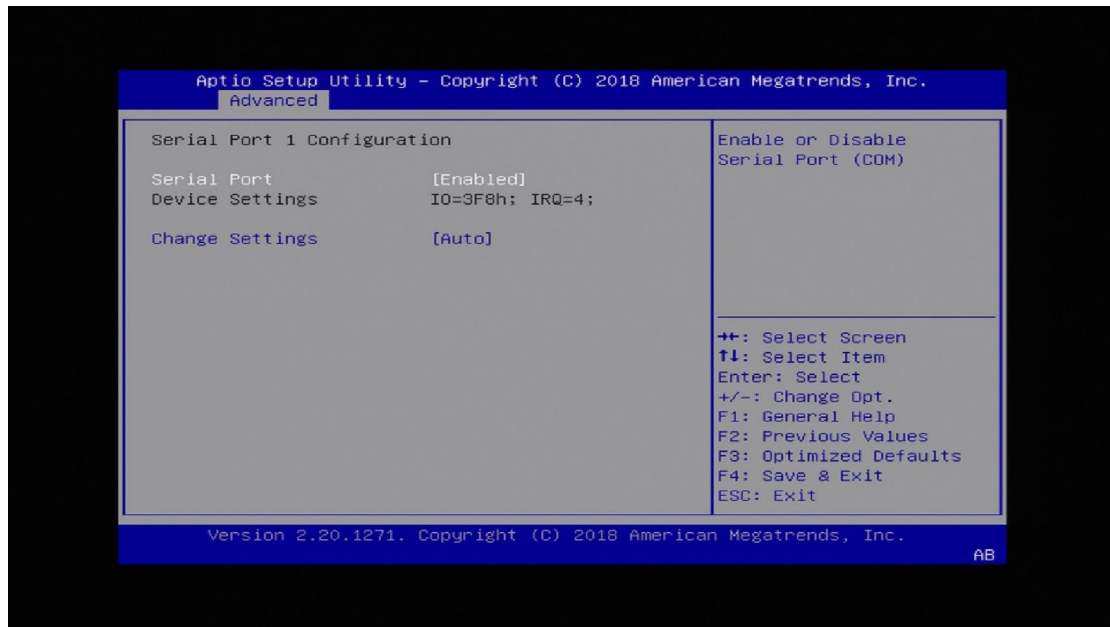

BIOS Setting	Description
Serial Port	Sets parameters of Serial Ports (COM).
Change Settings	<p>Selects an optimal settings for Super I/O device.</p> <p>Options:</p> <ul style="list-style-type: none"> <li>• Auto</li> <li>• IO = 3F8h; IRQ = 4</li> <li>• IO = 3F8h; IRQ = 3, 4, 5, 6, 7</li> <li>• IO = 2F8h; IRQ = 3, 4, 5, 6, 7</li> <li>• IO = 3E8h; IRQ = 3, 4, 5, 6, 7</li> <li>• IO = 2E8h; IRQ = 3, 4, 5, 6, 7</li> </ul>

### 3.4.5.2. Serial Port 2 Configuration

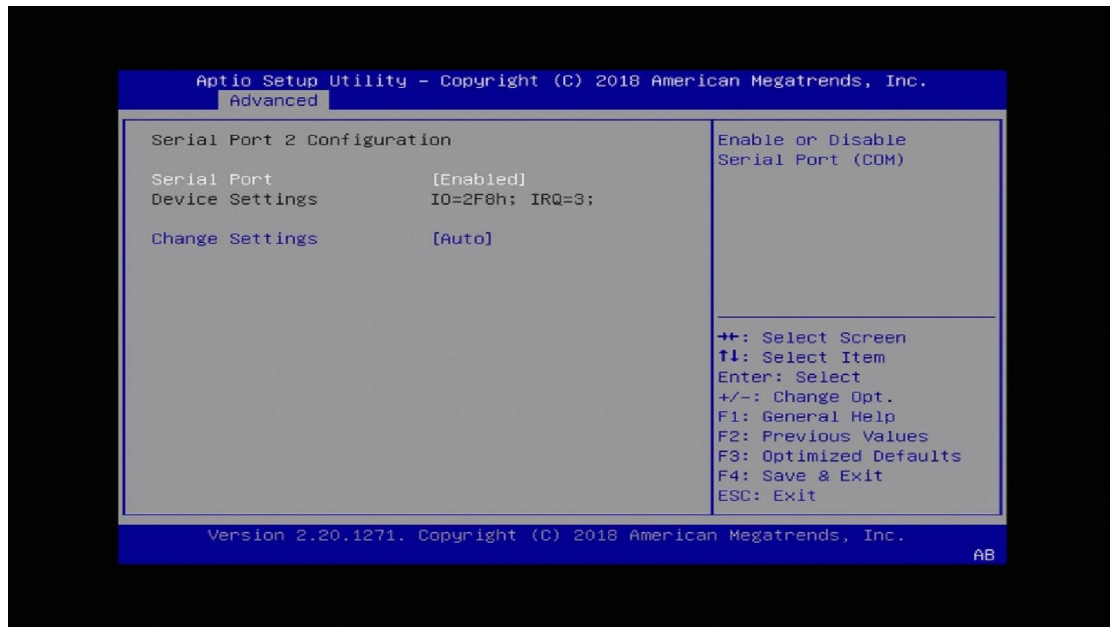

BIOS Setting	Description
Serial Port	Sets parameters of Serial Ports (COM).
Change Settings	<p>Selects an optimal settings for Super I/O device.</p> <p>Options:</p> <ul style="list-style-type: none"> <li>• Auto</li> <li>• IO = 2F8h; IRQ = 3</li> <li>• IO = 3F8h; IRQ = 3, 4, 5, 6, 7</li> <li>• IO = 2F8h; IRQ = 3, 4, 5, 6, 7</li> <li>• IO = 3E8h; IRQ = 3, 4, 5, 6, 7</li> <li>• IO = 2E8h; IRQ = 3, 4, 5, 6, 7</li> </ul>

## 3.4.6 NCT7904D HW Monitor

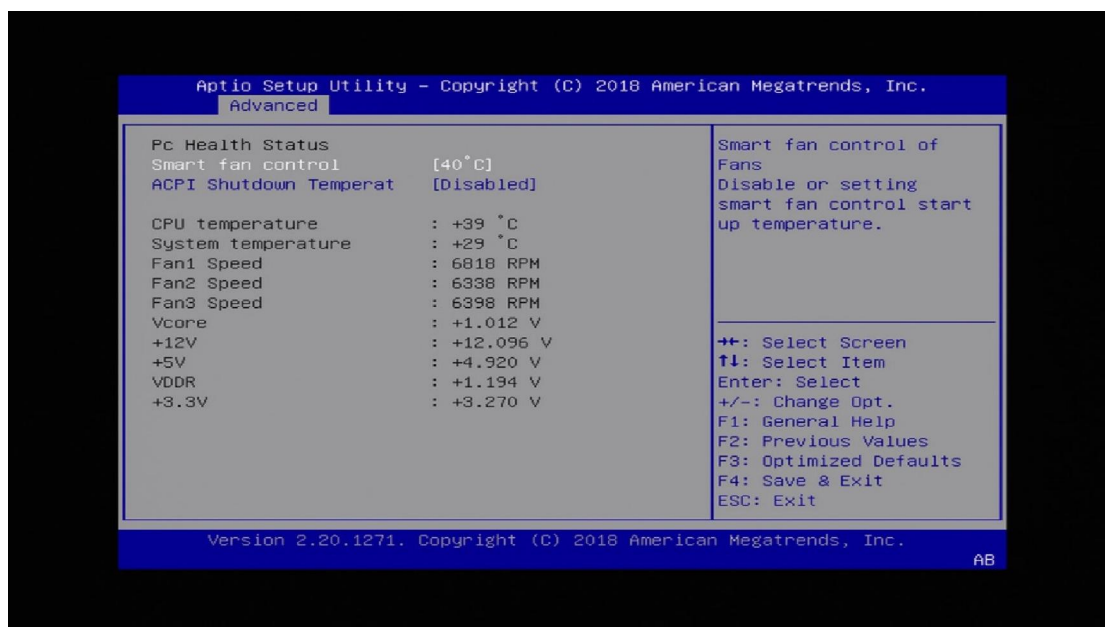

BIOS Setting	Description
Smart Fan Control	Disables or sets the smart fan control start up temperature. Options: Disabled, 40°C, 45°C, 50°C, 55°C, 60°C
ACPI Shutdown Temperature	Options: Disabled, 70°C, 75°C, 80°C, 85°C, 90°C, 95°C
Temperatures / Voltages / Fan Speed	These fields are the parameters of the hardware monitoring function feature of the motherboard. The values are read-only as monitored by the system and showing the PC health status

### 3.4.7 LAN Bypass Configuration

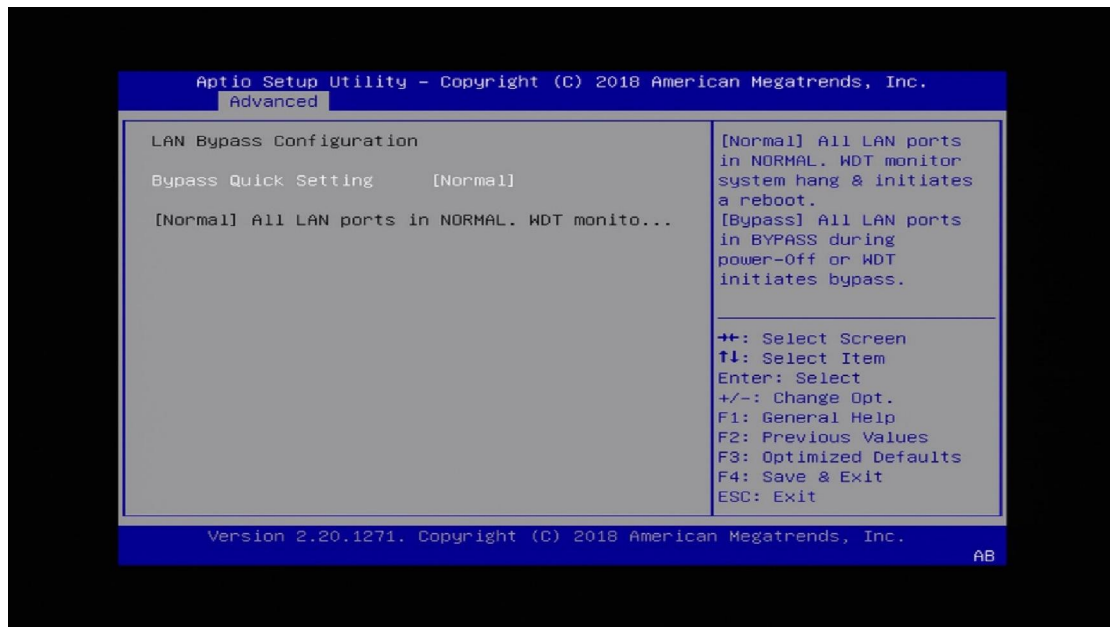

BIOS Setting	Description
Bypass Quick Setting	<ul style="list-style-type: none"> <li>• Bypass Mode: All LAN ports with bypass function in Bypass mode during power-off or WDT initiates bypass. System will not reboot.</li> <li>• Normal Mode: All LAN ports in normal mode. WDT monitor system hang &amp; initiates a reboot.</li> <li>• Firewall Mode: All LAN ports in bypass until OS has control ability to change LAN ports in normal.</li> <li>• Custom Define: All LAN ports can be configured independently.</li> </ul>

### 3.4.8 Serial Port Console Redirection

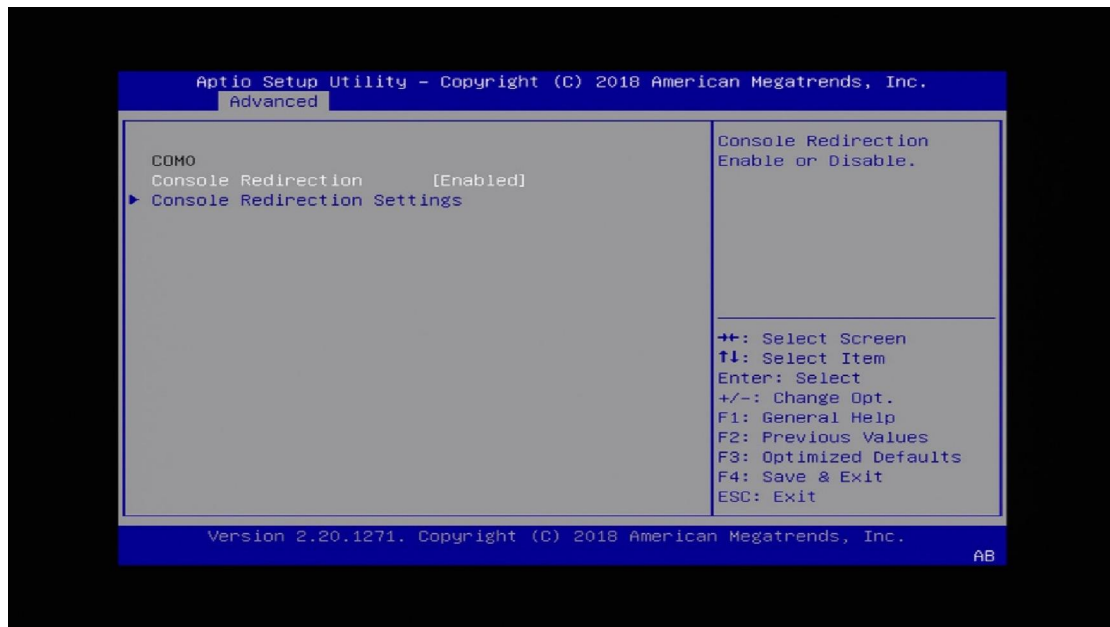

BIOS Setting	Description
Console Redirection	Enables / Disables Console Redirection.
Console Redirection Settings	The settings specify how the host computer and the remote computer (which the user is using) will exchange data. Both computers should have the same or compatible settings. Sets parameters of Console Redirection.

### 3.4.8.1. Console Redirection Settings

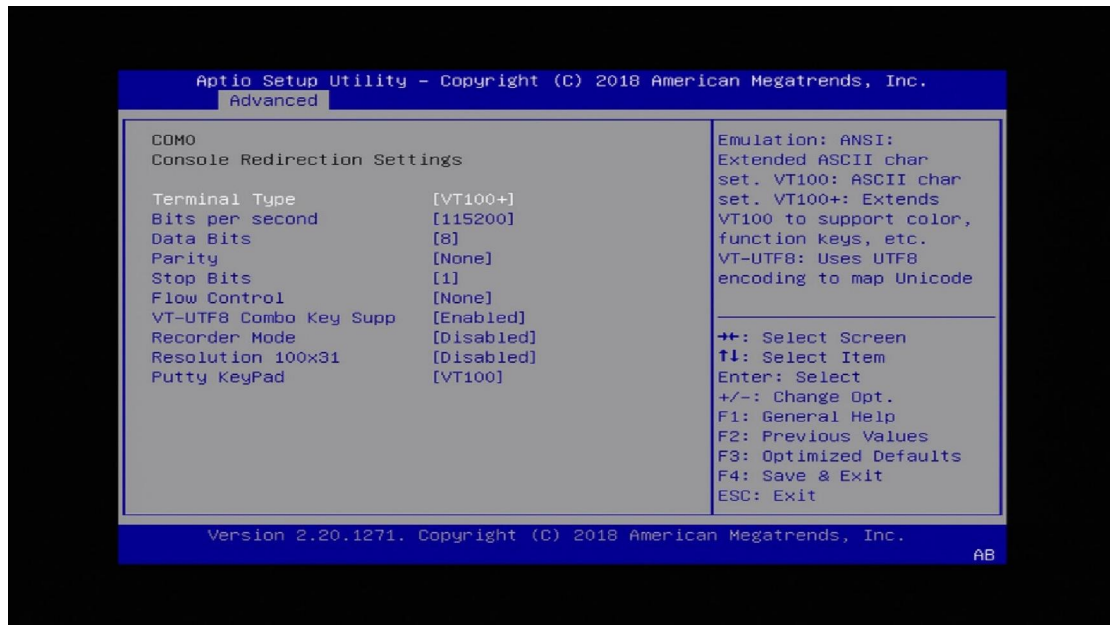

BIOS Setting	Description
Terminal Type	Emulation of the following options: <b>ANSI:</b> Extended ASCII charset. <b>VT100:</b> ASCII charset. <b>VT100+:</b> Extends VT100 to support color, function keys, etc. <b>VT-UTF8:</b> Uses UTF8 encoding to map Unicode.
Bits per second	Selects serial port transmission speed. The speed must be matched on the other side. Long or noisy lines may require lower speeds. Options: 9600, 19200, 38400, 57600, 115200
Data Bits	Selects the data bits as 7 or 8.
Parity	A parity bit can be sent with the data bits to detect some transmission errors. Options: None, Even, Odd, Mark, Space
Stop Bits	Stop bits indicate the end of a serial data packet. (A start bit indicates the beginning). The standard setting is 1 stop bit. Options: 1, 2
Flow Control	Flow control can prevent data loss from buffer overflow. When sending data, if the receiving buffers are full, a “stop” signal can be sent to stop the data flow. Options: None, Hardware RTS/CTS

BIOS Setting	Description
VT-UTF8 Combo Key Support	Enables / Disables VT-UTF8 combination key support for ANSI/VT100 terminals.
Recorder Mode	With this mode enabled only text will be sent. This is to capture terminal data.
Resolution 100x31	Enables / Disables extended terminal resolution.
Putty KeyPad	Select FunctionKey and KeyPad on Putty. Options: VT100, LINUX, XTERMR6, SCO, ESCN, VT400

### 3.4.9 USB Configuration

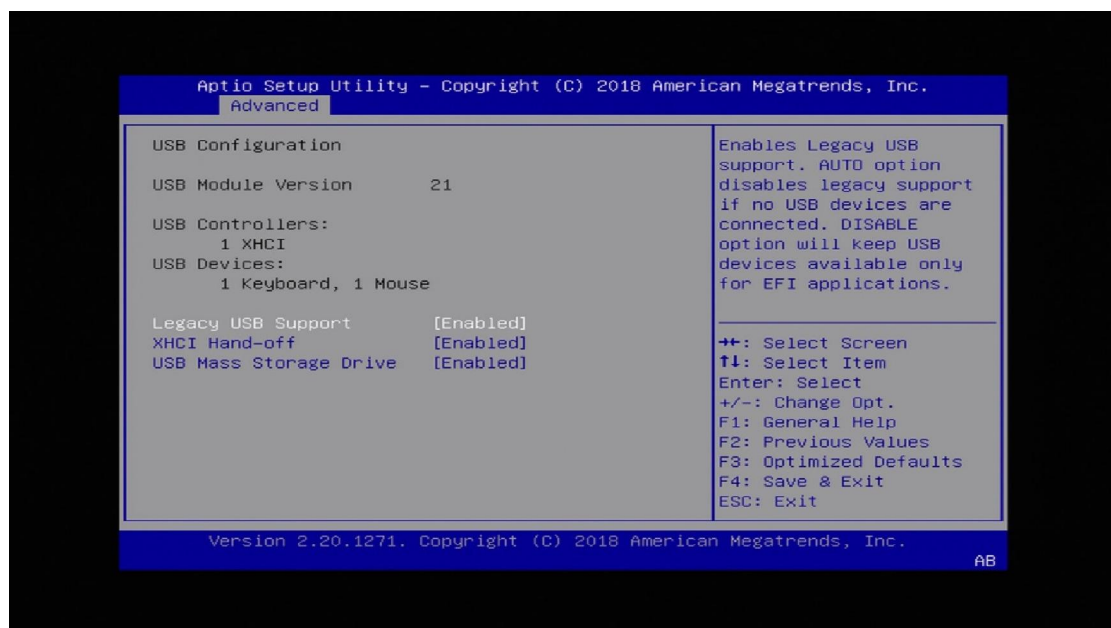

BIOS Setting	Description
Legacy USB Support	Enables / Disables Legacy USB support. <ul style="list-style-type: none"> <li>• <b>Auto</b> disables legacy support if there is no USB device connected.</li> <li>• <b>Disable</b> keeps USB devices available only for EFI applications.</li> </ul>
XHCI Hand-off	This is a workaround for OSeS without XHCI hand-off support. The XHCI ownership change should be claimed by XHCI driver.
USB Mass Storage Driver Support	Enables / Disables USB mass storage driver support.

## 3.5 Security Settings

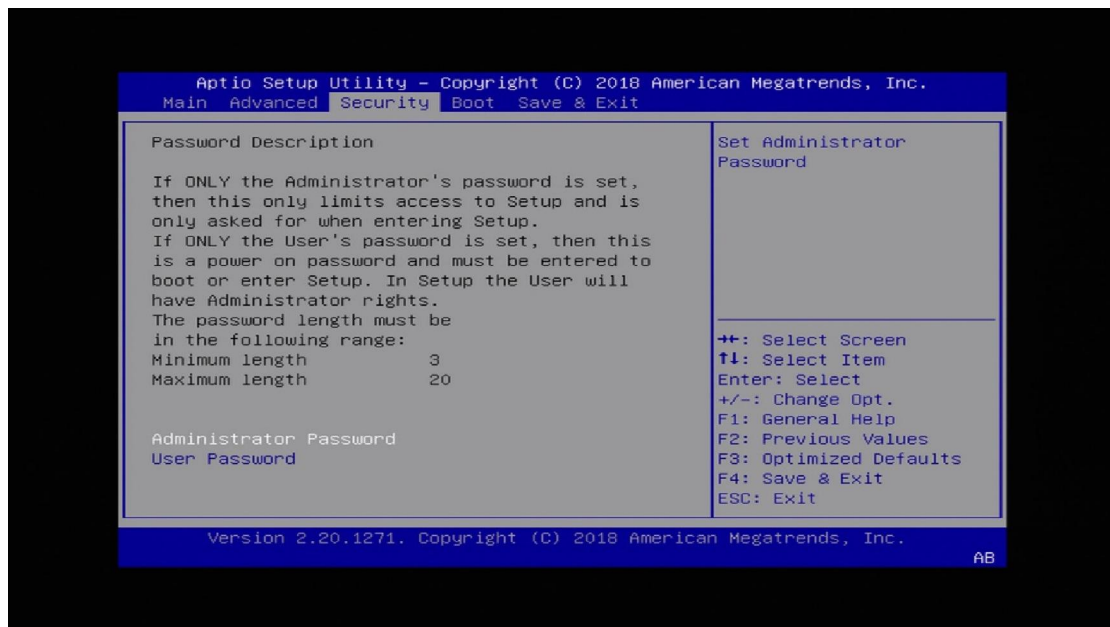

BIOS Setting	Description
Administrator Password	Sets an administrator password for the setup utility.
User Password	Sets a user password.

## 3.6 Boot Settings

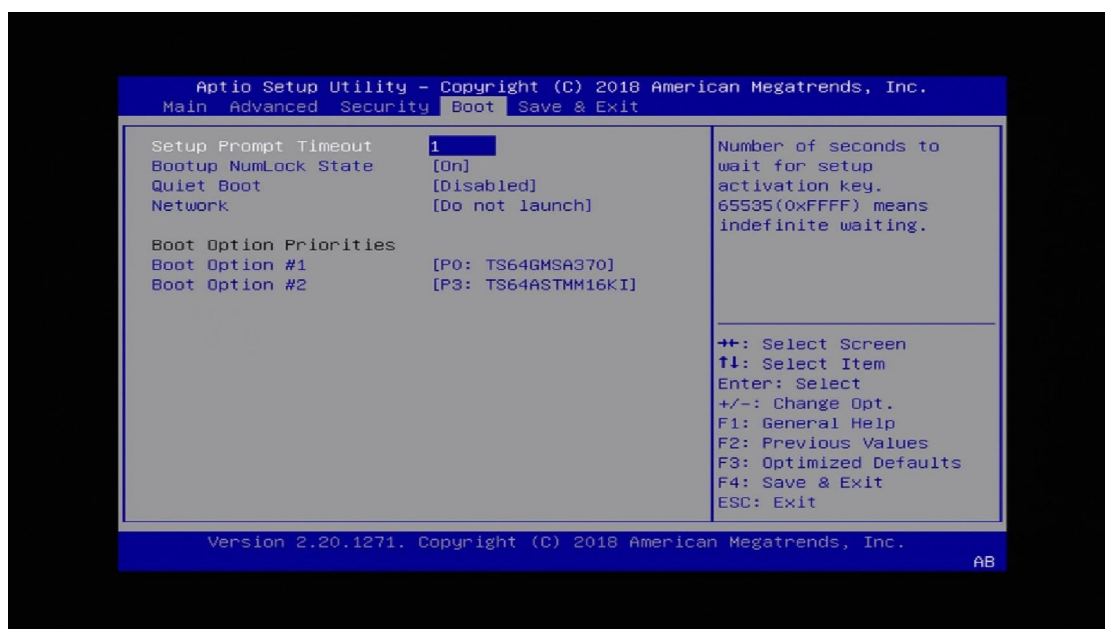

BIOS Setting	Description
Setup Prompt Timeout	Number of seconds to wait for setup activation key. 65535 (0xFFFF) means indefinite waiting.
Bootup NumLock State	Selects the keyboard NumLock state.
Quiet Boot	Enables / Disables Quiet Boot option.
Network	Controls the execution of UEFI and Legacy Network OpROM. Options: Do not launch, UEFI, Legacy
Boot Option Priorities	Sets the system boot order.

### 3.7 Save & Exit Settings

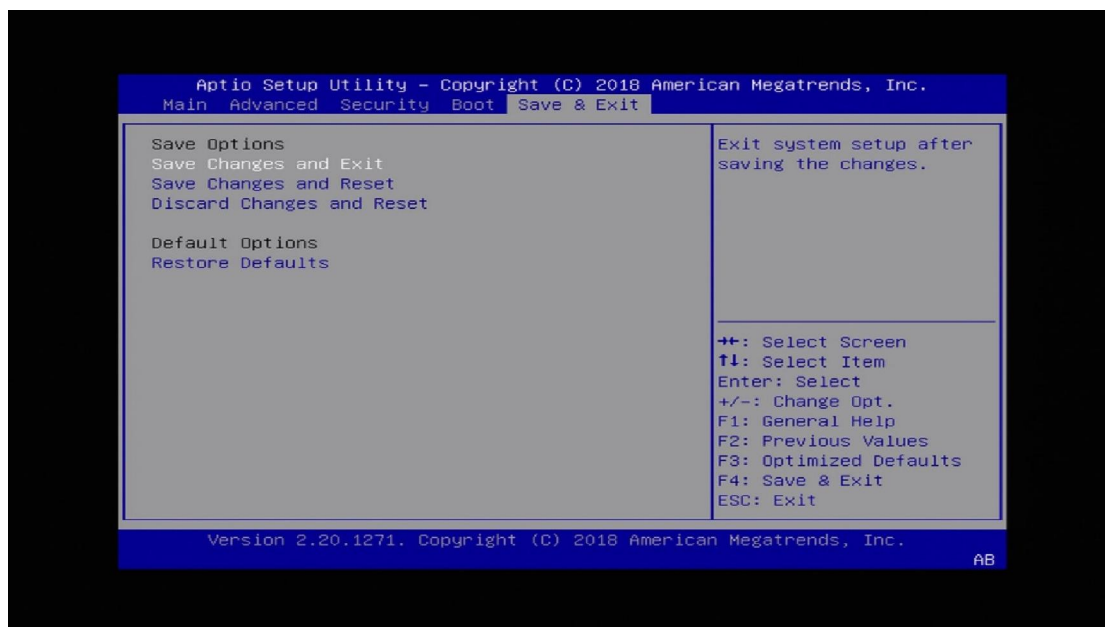

BIOS Setting	Description
Save Changes and Exit	Exits system setup after saving the changes.
Save Changes and Reset	Resets the system after saving the changes.
Discard Changes and Reset	Resets system setup without saving any changes.
Restore Defaults	Restores / Loads defaults values for all the setup options.

## Appendix

This section provides the mapping addresses of peripheral devices and the sample code of watchdog timer configuration.

- I/O Port Address Map
- Interrupt Request Lines (IRQ)
- Digital I/O Sample Code
- Watchdog Timer Configuration

## A. I/O Port Address Map

Each peripheral device in the system is assigned a set of I/O port addresses which also becomes the identity of the device. The following table lists the I/O port addresses used.

Address	Device Description
0x00000A00-0x00000A0F	Motherboard resources
0x00000A10-0x00000A1F	Motherboard resources
0x00000A20-0x00000A2F	Motherboard resources
0x0000002E-0x0000002F	Motherboard resources
0x0000004E-0x0000004F	Motherboard resources
0x00000061-0x00000061	Motherboard resources
0x00000063-0x00000063	Motherboard resources
0x00000065-0x00000065	Motherboard resources
0x00000067-0x00000067	Motherboard resources
0x00000070-0x00000070	Motherboard resources
0x00000080-0x00000080	Motherboard resources
0x00000092-0x00000092	Motherboard resources
0x000000B2-0x000000B3	Motherboard resources
0x00000680-0x0000069F	Motherboard resources
0x0000164E-0x0000164F	Motherboard resources
0x00000020-0x00000021	Programmable interrupt controller
0x00000024-0x00000025	Programmable interrupt controller
0x00000028-0x00000029	Programmable interrupt controller
0x0000002C-0x0000002D	Programmable interrupt controller
0x00000030-0x00000031	Programmable interrupt controller
0x00000034-0x00000035	Programmable interrupt controller
0x00000038-0x00000039	Programmable interrupt controller
0x0000003C-0x0000003D	Programmable interrupt controller
0x000000A0-0x000000A1	Programmable interrupt controller
0x000000A4-0x000000A5	Programmable interrupt controller
0x000000A8-0x000000A9	Programmable interrupt controller
0x000000AC-0x000000AD	Programmable interrupt controller

Address	Device Description
0x000000B0-0x000000B1	Programmable interrupt controller
0x000000B4-0x000000B5	Programmable interrupt controller
0x000000B8-0x000000B9	Programmable interrupt controller
0x000000BC-0x000000BD	Programmable interrupt controller
0x000004D0-0x000004D1	Programmable interrupt controller
0x00001854-0x00001857	Motherboard resources
0x00006000-0x00006FFF	Intel(R) PCI Express Root Port #7 - A33E
0x00004000-0x00004FFF	Intel(R) PCI Express Root Port #11 - A332
0x000003F8-0x000003FF	Communications Port (COM1)
0x000002F8-0x000002FF	Communications Port (COM2)
0x00001800-0x000018FE	Motherboard resources
0x000000F0-0x000000F0	Numeric data processor
0x00000000-0x00000CF7	PCI Express Root Complex
0x00000D00-0x0000FFFF	PCI Express Root Complex
0x00009090-0x00009097	Standard SATA AHCI Controller
0x00009080-0x00009083	Standard SATA AHCI Controller
0x00009060-0x0000907F	Standard SATA AHCI Controller
0x00007000-0x00007FFF	Intel(R) PCI Express Root Port #6 - A33D
0x00000040-0x00000043	System timer
0x00000050-0x00000053	System timer
0x00002000-0x000020FE	Motherboard resources
0x00009000-0x0000903F	Intel(R) UHD Graphics 630
0x000003B0-0x000003BB	Intel(R) UHD Graphics 630
0x000003C0-0x000003DF	Intel(R) UHD Graphics 630
0x00005000-0x00005FFF	Intel(R) PCI Express Root Port #8 - A33F
0x00003000-0x00003FFF	Intel(R) PCI Express Root Port #12 - A333
0x0000EFA0-0x0000EFBF	Intel(R) SMBus - A323
0x00008000-0x00008FFF	Intel(R) PCI Express Root Port #5 - A33C

## B. Interrupt Request Lines (IRQ)

Peripheral devices use interrupt request lines to notify CPU for the service required. The following table shows the IRQ used by the devices on board.

Level	Function
IRQ 9	Intel(R) Gaussian Mixture Model - 1911
IRQ 9	Intel(R) Thermal Subsystem - A379
IRQ 9	Intel(R) SMBus - A323
IRQ 4294967291	Intel(R) PCI Express Root Port #7 - A33E
IRQ 4294967289	Intel(R) PCI Express Root Port #11 - A332
IRQ 4294967277	Intel(R) USB 3.1 eXtensible Host Controller - 1.10 (Microsoft)
IRQ 4	Communications Port (COM1)
IRQ 3	Communications Port (COM2)
IRQ 13	Numeric data processor
IRQ 4294967287	Standard SATA AHCI Controller
IRQ 54 ~ IRQ 204	Microsoft ACPI-Compliant System
IRQ 256 ~ IRQ 511	Microsoft ACPI-Compliant System
IRQ 4294967292	Intel(R) PCI Express Root Port #6 - A33D
IRQ 4294967276	Intel(R) Management Engine Interface
IRQ 0	System timer
IRQ 4294967278	Intel(R) UHD Graphics 630
IRQ 4294967275	Intel(R) I211 Gigabit Network Connection #7
IRQ 4294967274	Intel(R) I211 Gigabit Network Connection #7
IRQ 4294967273	Intel(R) I211 Gigabit Network Connection #7
IRQ 4294967272	Intel(R) I211 Gigabit Network Connection #7
IRQ 4294967271	Intel(R) I211 Gigabit Network Connection #7
IRQ 4294967270	Intel(R) I211 Gigabit Network Connection #7
IRQ 4294967269	Intel(R) I211 Gigabit Network Connection #7
IRQ 4294967268	Intel(R) I211 Gigabit Network Connection #7
IRQ 4294967267	Intel(R) I211 Gigabit Network Connection #8
IRQ 4294967266	Intel(R) I211 Gigabit Network Connection #8
IRQ 4294967265	Intel(R) I211 Gigabit Network Connection #8
IRQ 4294967264	Intel(R) I211 Gigabit Network Connection #8

Level	Function
IRQ 4294967263	Intel(R) I211 Gigabit Network Connection #8
IRQ 4294967262	Intel(R) I211 Gigabit Network Connection #8
IRQ 4294967261	Intel(R) I211 Gigabit Network Connection #8
IRQ 4294967260	Intel(R) I211 Gigabit Network Connection #8
IRQ 4294967259	Intel(R) I211 Gigabit Network Connection #11
IRQ 4294967258	Intel(R) I211 Gigabit Network Connection #11
IRQ 4294967257	Intel(R) I211 Gigabit Network Connection #11
IRQ 4294967256	Intel(R) I211 Gigabit Network Connection #11
IRQ 4294967255	Intel(R) I211 Gigabit Network Connection #11
IRQ 4294967254	Intel(R) I211 Gigabit Network Connection #11
IRQ 4294967253	Intel(R) I211 Gigabit Network Connection #11
IRQ 4294967252	Intel(R) I211 Gigabit Network Connection #11
IRQ 4294967251	Intel(R) I211 Gigabit Network Connection #12
IRQ 4294967250	Intel(R) I211 Gigabit Network Connection #12
IRQ 4294967249	Intel(R) I211 Gigabit Network Connection #12
IRQ 4294967248	Intel(R) I211 Gigabit Network Connection #12
IRQ 4294967247	Intel(R) I211 Gigabit Network Connection #12
IRQ 4294967246	Intel(R) I211 Gigabit Network Connection #12
IRQ 4294967245	Intel(R) I211 Gigabit Network Connection #12
IRQ 4294967244	Intel(R) I211 Gigabit Network Connection #12
IRQ 4294967243	Intel(R) I211 Gigabit Network Connection #9
IRQ 4294967242	Intel(R) I211 Gigabit Network Connection #9
IRQ 4294967241	Intel(R) I211 Gigabit Network Connection #9
IRQ 4294967240	Intel(R) I211 Gigabit Network Connection #9
IRQ 4294967239	Intel(R) I211 Gigabit Network Connection #9
IRQ 4294967238	Intel(R) I211 Gigabit Network Connection #9
IRQ 4294967237	Intel(R) I211 Gigabit Network Connection #9
IRQ 4294967236	Intel(R) I211 Gigabit Network Connection #9
IRQ 4294967286	Intel(R) I211 Gigabit Network Connection #10
IRQ 4294967285	Intel(R) I211 Gigabit Network Connection #10
IRQ 4294967284	Intel(R) I211 Gigabit Network Connection #10

<b>Level</b>	<b>Function</b>
IRQ 4294967283	Intel(R) I211 Gigabit Network Connection #10
IRQ 4294967282	Intel(R) I211 Gigabit Network Connection #10
IRQ 4294967281	Intel(R) I211 Gigabit Network Connection #10
IRQ 4294967280	Intel(R) I211 Gigabit Network Connection #10
IRQ 4294967279	Intel(R) I211 Gigabit Network Connection #10
IRQ 14	Intel(R) Serial IO GPIO Host Controller - 3450
IRQ 4294967290	Intel(R) PCI Express Root Port #8 - A33F
IRQ 4294967288	Intel(R) PCI Express Root Port #12 - A333
IRQ 4294967293	Intel(R) PCI Express Root Port #5 - A33C
IRQ 4294967294	Intel(R) PCIe Controller (x16) - 1901

## C. Digital I/O Sample Code

### 1. The file NCT5523D.H

```
//-----
// THIS CODE AND INFORMATION IS PROVIDED "AS IS" WITHOUT WARRANTY OF ANY
// KIND, EITHER EXPRESSED OR IMPLIED, INCLUDING BUT NOT LIMITED TO THE
// IMPLIED WARRANTIES OF MERCHANTABILITY AND/OR FITNESS FOR A
// PARTICULAR
// PURPOSE.
//-----
#ifndef __NCT5523D_H
#define __NCT5523D_H          1
//-----
#define NCT5523D_INDEX_PORT (NCT5523D_BASE)
#define NCT5523D_DATA_PORT (NCT5523D_BASE+1)
//-----
#define NCT5523D_REG_LD      0x07
//-----
#define NCT5523D_UNLOCK     0x87
#define NCT5523D_LOCK       0xAA
//-----
unsigned int Init_NCT5523D(void);
void Set_NCT5523D_LD( unsigned char);
void Set_NCT5523D_Reg( unsigned char, unsigned char);
unsigned char Get_NCT5523D_Reg( unsigned char);
//-----
#endif    __NCT5523D_H
```

## 2. The file MAIN.CPP

```
//-----  
// THIS CODE AND INFORMATION IS PROVIDED "AS IS" WITHOUT WARRANTY OF ANY  
// KIND, EITHER EXPRESSED OR IMPLIED, INCLUDING BUT NOT LIMITED TO THE  
// IMPLIED WARRANTIES OF MERCHANTABILITY AND/OR FITNESS FOR A  
// PARTICULAR  
// PURPOSE.  
//-----  
#include <dos.h>  
#include <conio.h>  
#include <stdio.h>  
#include <stdlib.h>  
#include "NCT5523D.H"  
//-----  
int main (void);  
  
void Dio5Initial(void);  
void Dio5SetOutput(unsigned char);  
unsigned char Dio5GetInput(void);  
void Dio5SetDirection(unsigned char);  
unsigned char Dio5GetDirection(void);  
//-----  
int main (void)  
{  
    char SIO;  
  
    SIO = Init_NCT5523D();  
    if (SIO == 0)  
    {  
        printf("Can not detect Nuvoton NCT5523D, program abort.\n");  
        return(1);  
    }  
  
    Dio5Initial();  
  
    //for GPIO20..27  
    Dio5SetDirection(0x0F); //GP20..23 = input, GP24..27=output  
    printf("Current DIO direction = 0x%X\n", Dio5GetDirection());  
  
    printf("Current DIO status = 0x%X\n", Dio5GetInput());  
  
    printf("Set DIO output to high\n");  
    Dio5SetOutput(0x0F);  
  
    printf("Set DIO output to low\n");  
    Dio5SetOutput(0x00);  
  
    return 0;  
}  
//-----
```

```

void Dio5Initial(void)
{
    unsigned char ucBuf;

    ucBuf = Get_NCT5523D_Reg(0x1C);
    ucBuf &= ~0x02;
    Set_NCT5523D_Reg(0x1C, ucBuf);

    Set_NCT5523D_LD(0x07); //switch to logic device 7
    //enable the GP2 group
    ucBuf = Get_NCT5523D_Reg(0x30);
    ucBuf |= 0x04;
    Set_NCT5523D_Reg(0x30, ucBuf);
}
//-----
void Dio5SetOutput(unsigned char NewData)
{
    Set_NCT5523D_LD(0x07); //switch to logic device 7
    Set_NCT5523D_Reg(0xE1, NewData);
}
//-----
unsigned char Dio5GetInput(void)
{
    unsigned char result;

    Set_NCT5523D_LD(0x07); //switch to logic device 7
    result = Get_NCT5523D_Reg(0xE1);
    return (result);
}
//-----
void Dio5SetDirection(unsigned char NewData)
{
    //NewData : 1 for input, 0 for output
    Set_NCT5523D_LD(0x07); //switch to logic device 7
    Set_NCT5523D_Reg(0xE8, NewData);
}
//-----
unsigned char Dio5GetDirection(void)
{
    unsigned char result;

    Set_NCT5523D_LD(0x07); //switch to logic device 7
    result = Get_NCT5523D_Reg(0xE8);
    return (result);
}
//-----

```

### 3. The file NCT5523D.CPP

```
//-----  
// THIS CODE AND INFORMATION IS PROVIDED "AS IS" WITHOUT WARRANTY OF ANY  
// KIND, EITHER EXPRESSED OR IMPLIED, INCLUDING BUT NOT LIMITED TO THE  
// IMPLIED WARRANTIES OF MERCHANTABILITY AND/OR FITNESS FOR A  
// PARTICULAR  
// PURPOSE.  
//-----  
#include "NCT5523D.H"  
#include <dos.h>  
//-----  
unsigned int NCT5523D_BASE;  
void Unlock_NCT5523D (void);  
void Lock_NCT5523D (void);  
//-----  
unsigned int Init_NCT5523D(void)  
{  
    unsigned int result;  
    unsigned char ucDid;  
  
    NCT5523D_BASE = 0x4E;  
    result = NCT5523D_BASE;  
  
    ucDid = Get_NCT5523D_Reg(0x20);  
    if (ucDid == 0xC4) //NCT5523D??  
    {    goto Init_Finish;}  
  
    NCT5523D_BASE = 0x2E;  
    result = NCT5523D_BASE;  
  
    ucDid = Get_NCT5523D_Reg(0x20);  
    if (ucDid == 0xC4) //NCT5523D??  
    {    goto Init_Finish;}  
  
    NCT5523D_BASE = 0x00;  
    result = NCT5523D_BASE;  
  
Init_Finish:  
    return (result);  
}  
//-----  
void Unlock_NCT5523D (void)  
{  
    outportb(NCT5523D_INDEX_PORT, NCT5523D_UNLOCK);  
    outportb(NCT5523D_INDEX_PORT, NCT5523D_UNLOCK);  
}  
//-----  
void Lock_NCT5523D (void)  
{  
    outportb(NCT5523D_INDEX_PORT, NCT5523D_LOCK);  
}  
//-----
```

```
void Set_NCT5523D_LD( unsigned char LD)
{
    Unlock_NCT5523D();
    outportb(NCT5523D_INDEX_PORT, NCT5523D_REG_LD);
    outportb(NCT5523D_DATA_PORT, LD);
    Lock_NCT5523D();
}
//-----
void Set_NCT5523D_Reg( unsigned char REG, unsigned char DATA)
{
    Unlock_NCT5523D();
    outportb(NCT5523D_INDEX_PORT, REG);
    outportb(NCT5523D_DATA_PORT, DATA);
    Lock_NCT5523D();
}
//-----
unsigned char Get_NCT5523D_Reg(unsigned char REG)
{
    unsigned char Result;
    Unlock_NCT5523D();
    outportb(NCT5523D_INDEX_PORT, REG);
    Result = inportb(NCT5523D_DATA_PORT);
    Lock_NCT5523D();
    return Result;
}
//-----
```

## D. Watchdog Timer Configuration

The Watchdog Timer (WDT) is used to generate a variety of output signals after a user programmable count. The WDT is suitable for the use in the prevention of system lock-up, such as when software becomes trapped in a deadlock. Under these sorts of circumstances, the timer will count to zero and the selected outputs will be driven.

Under normal circumstance, you will need to restart the WDT at regular intervals before the timer counts to zero.

### 1. Sample Code: The file NCT5523D.H

```
//-----  
//  
// THIS CODE AND INFORMATION IS PROVIDED "AS IS" WITHOUT WARRANTY OF ANY  
// KIND, EITHER EXPRESSED OR IMPLIED, INCLUDING BUT NOT LIMITED TO THE  
// IMPLIED WARRANTIES OF MERCHANTABILITY AND/OR FITNESS FOR A  
// PARTICULAR  
// PURPOSE.  
//  
//-----  
#ifndef __NCT5523D_H  
#define __NCT5523D_H                1  
//-----  
#define NCT5523D_INDEX_PORT      (NCT5523D_BASE)  
#define NCT5523D_DATA_PORT      (NCT5523D_BASE+1)  
//-----  
#define NCT5523D_REG_LD          0x07  
//-----  
#define NCT5523D_UNLOCK          0x87  
#define NCT5523D_LOCK            0xAA  
//-----  
unsigned int Init_NCT5523D(void);  
void Set_NCT5523D_LD( unsigned char);  
void Set_NCT5523D_Reg( unsigned char, unsigned char);  
unsigned char Get_NCT5523D_Reg( unsigned char);  
//-----  
#endif    //__NCT5523D_H
```

## 2. Sample Code: The file MAIN.CPP

```
//-----
//
// THIS CODE AND INFORMATION IS PROVIDED "AS IS" WITHOUT WARRANTY OF ANY
// KIND, EITHER EXPRESSED OR IMPLIED, INCLUDING BUT NOT LIMITED TO THE
// IMPLIED WARRANTIES OF MERCHANTABILITY AND/OR FITNESS FOR A
// PARTICULAR
// PURPOSE.
//
//-----
#include <dos.h>
#include <conio.h>
#include <stdio.h>
#include <stdlib.h>
#include "NCT5523D.H"
//-----
int main (void);

void WDTInitial(void);
void WDTEnable(unsigned char);
void WDTDisable(void);

//-----
int main (void)
{
    char SIO;

    SIO = Init_NCT5523D();
    if (SIO == 0)
    {
        printf("Can not detect Nuvoton NCT5523D, program abort.\n");
        return(1);
    }

    WDTInitial();

    WDTEnable(10);

    WDTDisable();

    return 0;
}
//-----
void WDTInitial(void)
{
    unsigned char bBuf;
    Set_NCT5523D_LD(0x08); //switch to logic device 8
    bBuf = Get_NCT5523D_Reg(0x30);
    bBuf &= (~0x01);
    Set_NCT5523D_Reg(0x30, bBuf); //Enable WDTO
}
//-----
```

```

void WDTEnable(unsigned char NewInterval)
{
    unsigned char bBuf;

    Set_NCT5523D_LD(0x08);           //switch to logic device 8
    Set_NCT5523D_Reg(0x30, 0x01);   //enable timer

    bBuf = Get_NCT5523D_Reg(0xF0);
    bBuf &= (~0x08);
    Set_NCT5523D_Reg(0xF0, bBuf);   //count mode is second

    Set_NCT5523D_Reg(0xF1, NewInterval); //set timer
}
//-----
void WDTDisable(void)
{
    Set_NCT5523D_LD(0x08);           //switch to logic device 8
    Set_NCT5523D_Reg(0xF1, 0x00);   //clear watchdog timer
    Set_NCT5523D_Reg(0x30, 0x00);   //watchdog disabled
}
//-----

```

### 3. Sample Code: The file NCT5523D.CPP

```
//-----
//
// THIS CODE AND INFORMATION IS PROVIDED "AS IS" WITHOUT WARRANTY OF ANY
// KIND, EITHER EXPRESSED OR IMPLIED, INCLUDING BUT NOT LIMITED TO THE
// IMPLIED WARRANTIES OF MERCHANTABILITY AND/OR FITNESS FOR A
// PARTICULAR
// PURPOSE.
//
//-----
#include "NCT5523D.H"
#include <dos.h>
//-----
unsigned int NCT5523D_BASE;
void Unlock_NCT5523D (void);
void Lock_NCT5523D (void);
//-----
unsigned int Init_NCT5523D(void)
{
    unsigned int result;
    unsigned char ucDid;

    NCT5523D_BASE = 0x4E;
    result = NCT5523D_BASE;

    ucDid = Get_NCT5523D_Reg(0x20);
    if (ucDid == 0xC4)                //NCT5523D??
    {    goto Init_Finish;}

    NCT5523D_BASE = 0x2E;
    result = NCT5523D_BASE;

    ucDid = Get_NCT5523D_Reg(0x20);
    if (ucDid == 0xC4)                //NCT5523D??
    {    goto Init_Finish;}

    NCT5523D_BASE = 0x00;
    result = NCT5523D_BASE;

Init_Finish:
    return (result);
}
//-----
void Unlock_NCT5523D (void)
{
    outportb(NCT5523D_INDEX_PORT, NCT5523D_UNLOCK);
    outportb(NCT5523D_INDEX_PORT, NCT5523D_UNLOCK);
}
//-----
```

```

void Lock_NCT5523D (void)
{
    outportb(NCT5523D_INDEX_PORT, NCT5523D_LOCK);
}
//-----
void Set_NCT5523D_LD( unsigned char LD)
{
    Unlock_NCT5523D();
    outportb(NCT5523D_INDEX_PORT, NCT5523D_REG_LD);
    outportb(NCT5523D_DATA_PORT, LD);
    Lock_NCT5523D();
}
//-----
void Set_NCT5523D_Reg( unsigned char REG, unsigned char DATA)
{
    Unlock_NCT5523D();
    outportb(NCT5523D_INDEX_PORT, REG);
    outportb(NCT5523D_DATA_PORT, DATA);
    Lock_NCT5523D();
}
//-----
unsigned char Get_NCT5523D_Reg(unsigned char REG)
{
    unsigned char Result;
    Unlock_NCT5523D();
    outportb(NCT5523D_INDEX_PORT, REG);
    Result = inportb(NCT5523D_DATA_PORT);
    Lock_NCT5523D();
    return Result;
}
//-----

```