

IB905

Intel® Sandy Bridge / PCH
3.5-inch Embedded Board

USER'S MANUAL

Version 1.0

Acknowledgments

AMI is a registered trademark of American Megatrends Inc.

PS/2 is a trademark of International Business Machines Corporation.

Intel and Intel® Sandy Bridge DC Mobile Processor are registered trademarks of Intel Corporation.

Microsoft Windows is a registered trademark of Microsoft Corporation.

Fintek is a registered trademark of Fintek Electronics Corporation.

All other product names or trademarks are properties of their respective owners.

Table of Contents

Introduction	1
Product Description.....	1
Checklist.....	2
IB905 Specifications	3
Board Dimensions.....	5
Installations	6
Installing the CPU	7
Installing the Memory	8
Setting the Jumpers	9
Connectors on IB905	13
BIOS Setup.....	19
Drivers Installation	45
Intel Chipset Software Installation Utility.....	46
VGA Drivers Installation	47
Realtek HD Audio Driver Installation.....	48
LAN Drivers Installation.....	49
ASMedia USB 3.0 Drivers.....	51
Appendix.....	53
A. I/O Port Address Map	53
B. Interrupt Request Lines (IRQ).....	54
C. Watchdog Timer Configuration.....	55

This page is intentionally left blank.

Introduction

Product Description

The IB905 3.5-inch embedded board is based on the latest Intel® QM67 chipset. The platform supports 2nd generation Intel® Core processor family with rPGA988B packing and features an integrated dual-channel DDR3 memory controller as well as a graphics core.

The latest Intel® processors provide advanced performance in both computing and graphics quality. This meets the requirement of customers in the gaming, POS, digital signage and server market segment.

The Intel® QM67 is made with 32 nanometer technology that supports Intel's first processor architecture to unite the CPU and the graphics core on the transistor level. The IB905 3.5-inch embedded board utilizes the dramatic increase in performance provided by this Intel's latest cutting-edge technology. Measuring 102mm x 148mm, IB905 offers fast 6Gbps SATA support (2 ports), USB3.0 (2 ports) and interfaces for , DVI-I, LVDS displays. IB905 features Intel Active Management Technology 7.0.

IB905 FEATURES:

- Supports Intel® 2nd Generation Core i7/i5/i3 QC/DC mobile processors
- One DDR3 SoDIMM, 1066/1333MHz, Max. 4GB memory
- Dual Intel® PCI-Express Gigabit LAN
- Integrated Graphics for DVI-I/LVDS displays
- 2x SATA 3.0, 6x USB 2.0, USB 3.0 (2 ports), 2x COM, Watchdog timer
- 1x Mini PCI-E
- Digital I/O, LPC/Smart battery interface

Checklist

Your IB905 package should include the items listed below.

- The IB905 3.5-inch embedded board
- This User's Manual
- 1 CD containing chipset drivers and flash memory utility
- SATA-12 ;PK1-20B ;PW87 cable
- Optional SATA-5;Audio-18;USB29;HSIB905

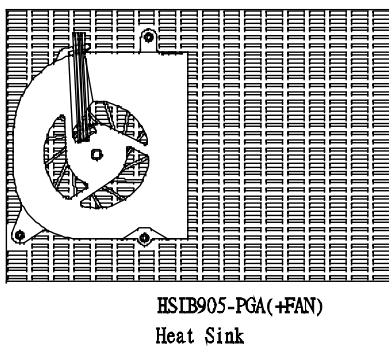
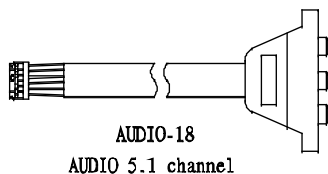
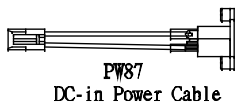
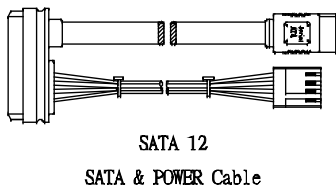
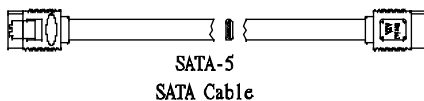
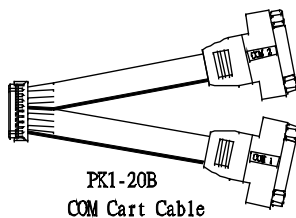
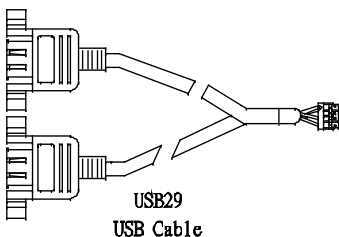

IB905 Specifications

Form Factor	3.5" Disk Size
CPU Type	- Intel® 2 nd generation Core™ i7/i5/i3/Celeron QC/DC mobile processor - rPGA package, 37.5 x 37.5 mm - TDP: QC = 45W~ 55W/ DC = 35W
CPU Speed	Up to 2.7GHz
Cache	Up to 8MB
CPU Socket	rPGA988B(Socket G2) @ solder side
Chipset	Intel® QM67 PCH @ solder side 25 x 27 mm package size , TDP=3.9W
BIOS	AMI BIOS, support ACPI Function
Memory	Intel® 2 nd generation Core™ i7/i5 QC/DC mobile processor integrated memory controller DDRIII 1066/1333/1600 MHz SO-DIMM x 1 (w/o ECC, 1.5V), Max. 8GB
VGA	Intel® 2 nd Gen. Core™ i7/i5/i3 mobile processor integrated Gfx DVI-I x 1 (thru Level shifter ASM1442) [<u>Thru Digital Port B</u>]
LVDS	24-bit dual channels LVDS interface w/DF13 socket x2
LAN	1. Intel® 82579V GbE PHY as 1 st LAN 2. Intel® 82583V PCIe GbE as 2 nd LAN
USB (Universal Serial Bus)	1. Intel® QM67 PCH integrated USB 2.0 host controller, 6 ports : 2-port in the rear panel + 4-ports via pin header 2. USB 3.0 host controller [<u>ASM1042</u>], support 2 ports in the rear panel [<u>Does not support DOS boot function</u>]
Serial ATA Ports	Intel® QM67 PCH built-in SATA controller, supports 2 x SATA 3.0 (6Gbps)
Audio	Intel® QM67 PCH built-in High Definition Audio controller + Realtek ALC662, support 5.1-channel
LPC I/O	<u>Winbond W83627DHG</u> COM1 (RS232 only) COM2 (RS232/422/485) with pin-18 with power @500 mA (jumper selectable for 5V or 12V) via DF11 2x10 pin connector Hardware Monitor: 2x Thermal inputs 2x Voltage monitoring 1x fan speed DC control
Digital IO	4 in & 4 out
IAMT(7.0)	N/A
Expansion Slots	Mini PCI-e socket x 1 , Half-sized type, reserved one <u>mounting hole only</u> ; [USB device support]
Edge Connector	DVI-I x1 RJ45 x2 for LAN 1&2 USB 3.0 stack connector x 1 for USB1 ~2 [Blue color] USB 2.0 stack connector x 1 for USB3 ~4

INTRODUCTION

On Board Header/Connector	2 ports x SATA III [Blue color] 2x4 pins header x 2 for 4 USB 2.0 ports[DF11] DF13-20 socket connector x 2 for 24-bit dual channel LVDS 2x6 pins box header x1 for Audio [DF11] 2x10 pins box header x 1 for COM1~2 [DF11] 2x5 pins headers x 1 for LPC Digital IO Mini PCI-e(1x) connector x 1 [Half-sized] 5 pins box header x 1 for smart battery 4 pins box header x 1 for backlight/brightness control 4 pins power connector x 1 for SATA HDD 2 pins power connector x 1 for 12V DC-in [180 degree vertical type]
Watchdog Timer	Yes (256 segments, 0, 1, 2...255 sec/min)
Power Connector	+12V DC-in only
RoHS	Yes
Board Size	102mm x 147mm
Others	

Board Dimensions

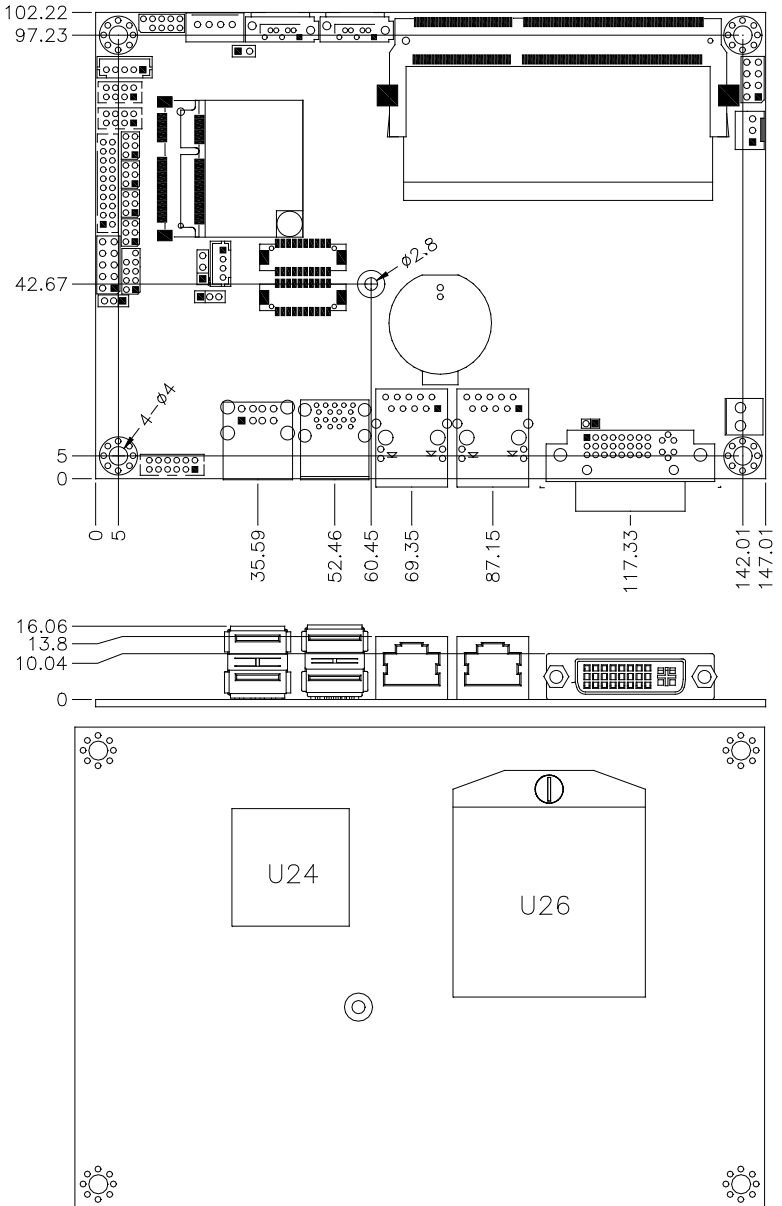

Installations

This section provides information on how to use the jumpers and connectors on the IB905 in order to set up a workable system. The topics covered are:

Installing the CPU	7
Installing the Memory	8
Setting the Jumpers	9
Connectors on IB905	13

Installing the CPU

The IB905 board supports rPGA988B socket for Intel® Sandy Bridge Dual Core mobile processors.

The processor socket comes with a screw to secure the processor. As shown in the left picture below, loosen the screw first before inserting the processor. Place the processor into the socket by making sure the notch on the corner of the CPU corresponds with the notch on the inside of the socket. Once the processor has slide into the socket, fasten the screw. Refer to the figures below.

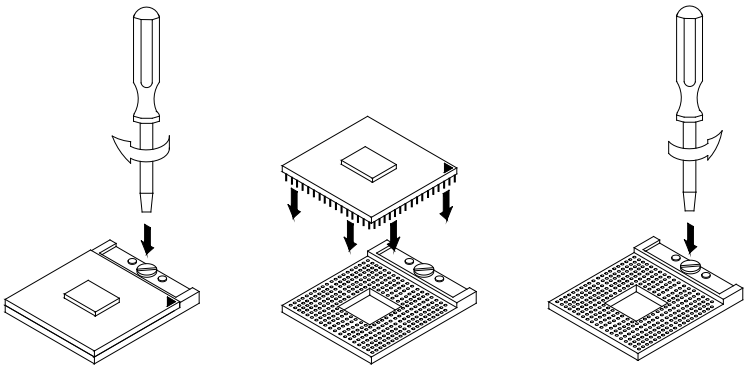

NOTE: Ensure that the CPU heat sink and the CPU top surface are in total contact to avoid CPU overheating problem that would cause your system to hang or be unstable.

Installing the Memory

The IB905 board supports one DDR3 memory socket for a maximum total memory of 4GB in DDR3 SO-DIMM memory type.

Installing and Removing Memory Modules

To install the DDR3 modules, locate the memory slot on the board and perform the following steps:

1. Hold the DDR3 module so that the key of the DDR3 module aligns with that on the memory slot. Insert the module into the socket at a slight angle (approximately 30 degrees). Note that the socket and module are both keyed, which means that the module can be installed only in one direction.
2. To seat the memory module into the socket, apply firm and even pressure to each end of the module until you feel it slip down into the socket.
3. With the module properly seated in the socket, rotate the module downward. Continue pressing downward until the clips at each end lock into position.
4. To remove the DDR3 module, press the clips with both hands.

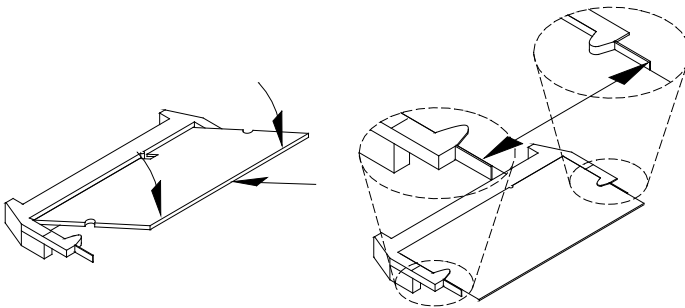

Setting the Jumpers

Jumpers are used on IB905 to select various settings and features according to your needs and applications. Contact your supplier if you have doubts about the best configuration for your needs. The following lists the connectors on IB905 and their respective functions.

Jumper Locations on IB905.....	10
JP5, JP6, JP8: RS232/RS422/RS485 (COM2) Selection	11
JP9: COM2 RS232 RI/+5V/+12V Power Setting.....	11
J7: LCD Panel Power Selection.....	12
J1: Flash Descriptor Security Override (Factory use only)	12
J8: ATX or AT Power Selection.....	12
J9: Clear CMOS Contents.....	12

Jumper Locations on IB905

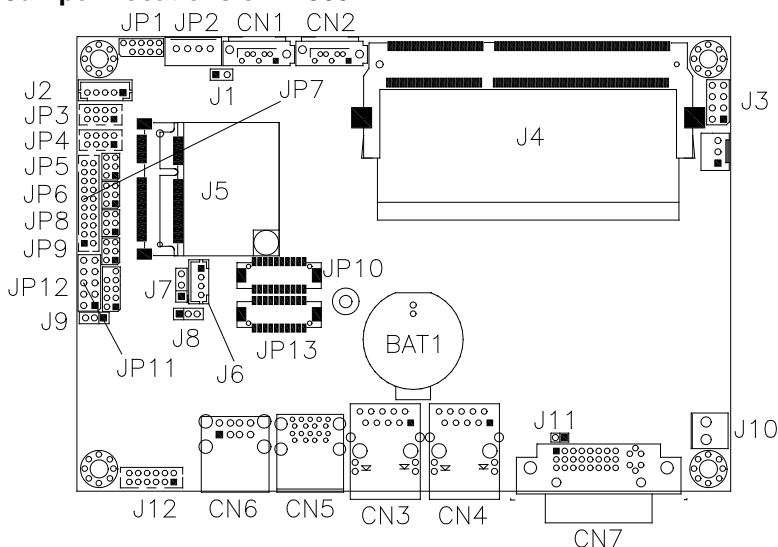

Jumpers on IB905 Page

JP5, JP6, JP8: RS232/RS422/RS485 (COM2) Selection..... 11

JP9: COM2 RS232 RI/+5V/+12V Power Setting 11

J7: LCD Panel Power Selection 12

J1: Flash Descriptor Security Override (Factory use only)..... 12

J8: ATX or AT Power Selection 12

J9: Clear CMOS Contents..... 12

JP5, JP6, JP8: RS232/RS422/RS485 (COM2) Selection

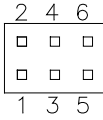



COM2 Function	RS-232	RS-422	RS-485
Jumper Setting (pin closed)	JP5: 3-5&4-6	JP5: 1-3&2-4	JP5: 1-3&2-4
	JP8: 1-2	JP8: 3-4	JP8: 5-6
	JP6: 3-5 & 4-6	JP6: 1-3 & 2-4	JP6: 1-3 & 2-4

JP9: COM2 RS232 RI/+5V/+12V Power Setting

JP9	Setting	Function
<p>A diagram of a 3x2 jumper block. The top row has pins labeled 1, 2. The middle row has pins labeled 3, 4. The bottom row has pins labeled 5, 6. Each pin position contains a small square representing a jumper.</p>	Pin 1-2 Short/Closed	+12V
	Pin 3-4 Short/Closed	RI
	Pin 5-6 Short/Closed	+5V



J7: LCD Panel Power Selection

J7	LCD Panel Power
	3.3V
	5V



J1: Flash Descriptor Security Override (Factory use only)

J1	Flash Descriptor Security Override
Open	Disabled (Default)
Close	Enabled

J8: ATX or AT Power Selection

J8	Setting	Function
	Pin 1-2 Short/Closed	ATX Mode
	Pin 2-3 Short/Closed	AT Mode

J9: Clear CMOS Contents

J9	Setting	Function
	Pin 1-2 Short/Closed	Normal
	Pin 2-3 Short/Closed	Clear CMOS

Connectors on IB905

J10: DC-IN 12V Power Connector	15
J3: Front Panel Connector	15
SYS_FAN1:DC-system Fan Power Connector.....	15
JP2: HDD Power Connector.....	15
J2: Smart Battery Interface Connector.....	15
JP10, JP13: LVDS1, LVDS2 Connectors (1st/2nd channel).....	16
J6: LCD Backlight Connector (DC type).....	16
JP7: COM1, COM2 Serial Port (DF11 Connector).....	16
J12: Audio Connector (DF11 Connector).....	17
JP11: Digital I/O.....	17
JP3, JP4: USB3~USB6 Connector(DF11 Connector).....	17
CN7: DVI-I Connector	18
CN5: USB3.0 Connector	18
CN6: USB2.0 Connector	18
CN4: Gigabit LAN (Intel 82579LM).....	18
CN3: Gigabit LAN (Intel 82583V).....	18
J5: Mini-PCIE Connector	18
CN1, CN2: SATA Connectors.....	18
JP12: LPC Debug Connector (Factory use only).....	18
JP1: SPI Flash Connector (Factory use only)	18

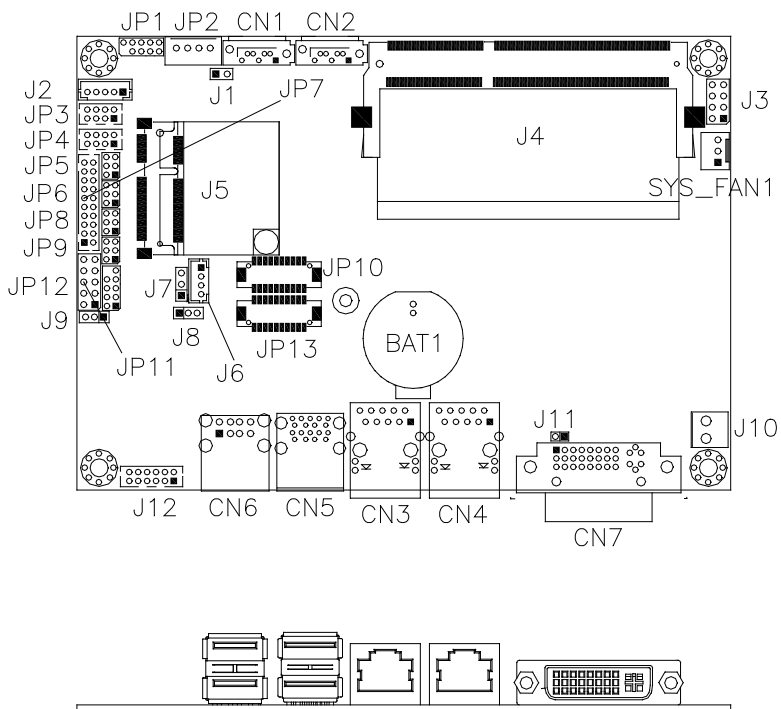

J10: DC-IN 12V Power Connector

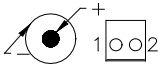

Pin #	Signal Name
1	DC in (12V only)
2	Ground

J3: Front Panel Connector

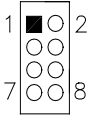

Signal Name	Pin #	Pin #	Signal Name
Power BTN	1	2	Power BTN
HDD LED+	3	4	HDD LED-
Reset BTN	5	6	Reset BTN
Power LED+	7	8	Power LED-

SYS_FAN1:DC-system Fan Power Connector

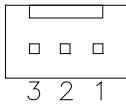

Pin #	Signal Name
1	Ground
2	+12V
3	NC

JP2: HDD Power Connector



Pin #	Signal Name
1	+5V
2	Ground
3	Ground
4	+12V

J2: Smart Battery Interface Connector



Pin #	Signal Name
1	RST
2	EXTSMI
3	Ground
4	DATA
5	CLK

JP10, JP13: LVDS1, LVDS2 Connectors (1st/2nd channel)

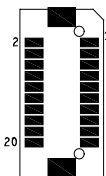

Signal Name	Pin #	Pin #	Signal Name
TX0-	2	1	TX0+
Ground	4	3	Ground
TX1-	6	5	TX1+
*5V/3.3V	8	7	Ground
TX3-	10	9	TX3+
TX2-	12	11	TX2+
Ground	14	13	Ground
TXC-	16	15	TXC+
*5V/3.3V	18	17	ENABKL
+12V	20	19	+12V

* Remarks: These connectors support 24-bit. JP10 is 1st channel. JP13 is 2nd channel. J7 can be used to set 1-2 3.3V or 2-3 5V.

J6: LCD Backlight Connector (DC type)



Pin #	Signal Name
1	+12V
2	Backlight Enable
3	*Backlight Adj (DC type)
4	Ground

* LCD backlight brightness can be adjusted by the OS or in the BIOS setup. In the BIOS setup, both backlight enable/disable and backlight brightness can be configured. Also, the backlight voltage can be set to 3.3V or 5V.

JP7: COM1, COM2 Serial Port (DF11 Connector)

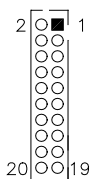

Signal Name	Pin #	Pin #	Signal Name
DSR1 Data set ready	2	1	DCD1 Data carrier detect
RTS1 Request to send	4	3	RXD1 Receive data
CTS1 Clear to send	6	5	TXD1 Transmit data
RI1 Ringing indicator	8	7	DTR1 Data terminal ready
Not used	10	9	Ground
DSR2	12	11	DCD2
RTS2	14	13	RXD2
CTS2	16	15	TXD2
RI2	18	17	DTR2
Not used	20	19	Ground

COM2 is jumper selectable for RS-232, RS-422 and RS-485.

Pin #	Signal Name		
	RS-232	R2-422	RS-485
11	DCD	TX-	DATA-
13	RX	TX+	DATA+
15	TX	RX+	NC
17	DTR	RX-	NC
19	Ground	Ground	Ground
12	DSR	NC	NC
14	RTS	NC	NC
16	CTS	NC	NC
18	RI	NC	NC
20	NC	NC	NC

J12: Audio Connector (DF11 Connector)

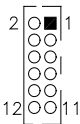

Signal Name	Pin #	Pin #	Signal Name
LINEOUT R	2	1	LINEOUT L
Ground	4	3	JD FRONT
LINEIN R	6	5	LINEIN
Ground	8	7	JD LINEIN
MIC-In	10	9	MIC L
Ground	12	11	JD MIC1

JP11: Digital I/O

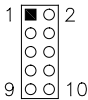

Signal Name	Pin	Pin	Signal Name
GND	1	2	VCC
OUT3	3	4	OUT1
OUT2	5	6	OUT0
IN3	7	8	IN1
IN2	9	10	IN0

JP3, JP4: USB3~USB6 Connector(DF11 Connector)

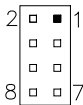

Signal Name	Pin	Pin	Signal Name
Ground	2	1	Vcc
D4+	4	3	D3-
D4-	6	5	D3+
Vcc	8	7	Ground

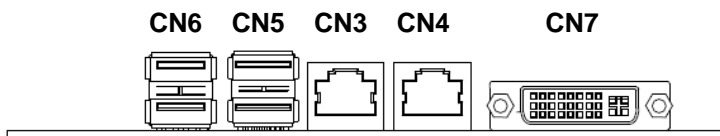

CN7: DVI-I Connector

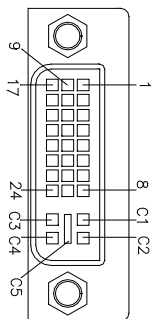

Signal Name	Pin #	Pin #	Signal Name
DATA 2-	1	16	HOT POWER
DATA 2+	2	17	DATA 0-
Shield 2/4	3	18	DATA 0+
DATA 4-	4	19	SHIELD 0/5
DATA 4+	5	20	DATA 5-
DDC CLOCK	6	21	DATA 5+
DDC DATA	7	22	SHIELD CLK
Anlog-Vsync	8	23	CLOCK -
DATA 1-	9	24	CLOCK +
DATA 1+	10	C1	Anlog-Red
SHIELD 1/3	11	C2	Anlog-Green
DATA 3-	12	C3	Anlog-Blue
DATA 3+	13	C4	Anlog-Hync
DDC POWER	14	C5	A GROUND2
A GROUND 1	15	C6	A GROUND3

CN5: USB3.0 Connector

CN6: USB2.0 Connector

CN4: Gigabit LAN (Intel 82579LM)

CN3: Gigabit LAN (Intel 82583V)

J5: Mini-PCIE Connector

CN1, CN2: SATA Connectors

JP12: LPC Debug Connector (Factory use only)

JP1: SPI Flash Connector (Factory use only)

BIOS Setup

This chapter describes the different settings available in the AMI BIOS that comes with the board. The topics covered in this chapter are as follows:

BIOS Introduction	20
BIOS Setup	20
Main BIOS Setup.....	21
Advanced Settings	22
Chipset Settings	35
Boot Settings.....	41
Security Settings	42
Save & Exit Settings.....	43

BIOS Introduction

The BIOS (Basic Input/Output System) installed in your computer system's ROM supports Intel processors. The BIOS provides critical low-level support for a standard device such as disk drives, serial ports and parallel ports. It also password protection as well as special support for detailed fine-tuning of the chipset controlling the entire system.

BIOS Setup

The BIOS provides a Setup utility program for specifying the system configurations and settings. The BIOS ROM of the system stores the Setup utility. When you turn on the computer, the BIOS is immediately activated. Pressing the key immediately allows you to enter the Setup utility. If you are a little bit late pressing the key, POST (Power On Self Test) will continue with its test routines, thus preventing you from invoking the Setup. If you still wish to enter Setup, restart the system by pressing the "Reset" button or simultaneously pressing the <Ctrl>, <Alt> and <Delete> keys. You can also restart by turning the system Off and back On again. The following message will appear on the screen:

```
Press <DEL> or <F2> to Enter Setup
```

In general, you press the arrow keys to highlight items, <Enter> to select, the <PgUp> and <PgDn> keys to change entries, <F1> for help and <Esc> to quit.

When you enter the Setup utility, the Main Menu screen will appear on the screen. The Main Menu allows you to select from various setup functions and exit choices.

Main BIOS Setup

This setup allows you to record some basic hardware configurations in your computer system and set the system clock.

Aptio Setup Utility – Copyright © 2010 American Megatrends, Inc.

Main	Advanced	Chipset	Boot	Security	Save & Exit
BIOS INFORMATION					
System Language		[English]			
System Date		[Tue 01/06/2009]			→ ← Select Screen
System Time		[00:08:21]			↑ ↓ Select Item
Access Level		Administrator			Enter: Select
					+ - Change Field
					F1: General Help
					F2: Previous Values
					F3: Optimized Default
					F4: Save & Exit
					ESC: Exit

Note: *If the system cannot boot after making and saving system changes with Setup, the AMI BIOS supports an override to the CMOS settings that resets your system to its default.*

Warning: *It is strongly recommended that you avoid making any changes to the chipset defaults. These defaults have been carefully chosen by both AMI and your system manufacturer to provide the absolute maximum performance and reliability. Changing the defaults could cause the system to become unstable and crash in some cases.*

System Language

Choose the system default language.

System Date

Set the Date. Use Tab to switch between Data elements.

System Time

Set the Time. Use Tab to switch between Data elements.

Advanced Settings

This section allows you to configure and improve your system and allows you to set up some system features according to your preference.

Aptio Setup Utility					
Main	Advanced	Chipset	Boot	Security	Save & Exit
	Legacy OpROM Support				
	Launch PXE OpROM		[Disabled]		
	Launch Storage OpROM		[Enabled]		
	▶ PCI Subsystem Settings				
	▶ ACPI Settings				
	▶ Wake up event setting				
	▶ CPU Configuration				→ ← Select Screen
	▶ Shutdown Temperature Configuration				↑ ↓ Select Item
	▶ SATA Configuration				Enter: Select
	▶ USB Configuration				+ - Change Field
	▶ Super IO Configuration				F1: General Help
	▶ H/W Monitor				F2: Previous Values
	▶ Serial Port Console Redirection				F3: Optimized Default
	▶ Sandybridge DTS Configuration				F4: Save & EXIT
	▶ Sandybridge PPM Configuration				ESC: Exit

Launch PXE OpROM

Enable or Disable Boot Option for Legacy Network Devices.

Launch Storage OpROM

Enable or Disable Boot Option for Legacy Mass Storage Devices with Option ROM.

PCI Subsystem Settings

This section allows you to configure the PCI, PCI-X and PCI Express settings.

Aptio Setup Utility

Main	Advanced	Chipset	Boot	Security	Save & Exit
	PCI Bus Driver Version		V 2.03.00		
	PCI ROM Priority		EFI Compatible ROM		
	PCI Common Settings				
	PCI Latency Timer		32 PCI Bus Clocks		
	VGA Palette Snoop		Disabled		
	PERR# Generation		Disabled		
	SERR# Generation		Disabled		
	PCI Express Device Settings				
	Relaxed Ordering		Disabled		→ ← Select Screen
	Extended Tag		Disabled		↑ ↓ Select Item
	No Snoop		Enabled		Enter: Select
	Maximum Payload		Auto		+ - Change Field
	Maximum Read Request		Auto		F1: General Help
	PCI Express Link Settings				F2: Previous Values
	ASPM Support		Disabled		F3: Optimized Default
	WARNING: Enabling ASPM may cause some PCI-E devices to fail				F4: Save & Exit
	Extended Synch		Disabled		ESC: Exit

PCI ROM Priority

In case of multiple Option ROMs (Legacy and EFI Compatible), specifies what PCI Option ROM to launch.

PCI Latency Timer

Value to be programmed into PCI Latency Timer Register.

VGA Palette Snoop

Enables or Disables VGA Palette Registers Snooping.

PERR# Generation

Enables or Disables PCI Device to Generate PERR#.

SERR# Generation

Enables or Disables PCI Device to Generate SERR#.

Relaxed Ordering

Enables or Disables PCI Express Device Relaxed Ordering.

Extended Tag

If ENABLED allows Device to use 8-bit Tag field as a requester.

No Snoop

Enables or Disables PCI Express Device No Snoop option.

Maximum Payload

Set Maximum Payload of PCI Express Device or allow System BIOS to select the value.

Maximum Read Request

Set Maximum Read Request Size of PCI Express Device or allow System BIOS to select the value.

ASPM Support

Set the ASPM Level: Force L0- Force all links to L0 Stage:
AUTO – BIOS auto configure:
DISABLE- Disables ASPM.

Extended Synch

If ENABLED allows generation of Extended Synchronization patterns.

ACPI Settings

System ACPI Parameters.

Aptio Setup Utility

Main	Advanced	Chipset	Boot	Security	Save & Exit
	Enable ACPI Auto Configuration		Disabled		→ ← Select Screen ↑ ↓ Select Item Enter: Select +- Change Field F1: General Help F2: Previous Values F3: Optimized Default F4: Save & Exit ESC: Exit
	Enable Hibernation		Enabled		
	ACPI Sleep State		S3 (Suspend to R...)		
	Lock Legacy Resources		Disabled		

Enable ACPI Auto Configuration

Enables or Disables BIOS ACPI Auto Configuration.

Enable Hibernation

Enables or Disables System ability to Hibernate (OS/S4 Sleep State). This option may be not effective with some OS.

ACPI Sleep State

Select the highest ACPI sleep state the system will enter, when the SUSPEND button is pressed.

Lock Legacy Resources

Enables or Disables System Lock of Legacy Resources.

Wake up event settings

Enable/Disable Wake up event.

Aptio Setup Utility

Main	Advanced	Chipset	Boot	Security	Save & Exit
			Wake system with Fixed Time	Disabled	→ ← Select Screen ↑ ↓ Select Item Enter: Select +- Change Field F1: General Help F2: Previous Values F3: Optimized Default F4: Save & Exit ESC: Exit
			Wake on PME	Disabled	
			Wake on PCIE Wake Event	Disabled	

Wake system with Fixed Time

Enables or Disables System wake on alarm event. When enabled, System will wake on the hr::min:: sec specified.

Wake on Ring

The options are Disabled and Enabled.

Wake on PCIE Wake Event

The options are Disabled and Enabled.

CPU Configuration

This section shows the CPU configuration parameters.

Aptio Setup Utility					
Main	Advanced	Chipset	Boot	Security	Save & Exit
CPU Configuration					
Intel® Core™ i7-7210QE CPU @ 2.10GHz					
Processor Stepping			206a7		
Microcode Revision			D		
Max Processor Speed			2100 MHz		
Min Processor Speed			800 MHz		
Processor Speed			2100 MHz		
Processor Cores			4		
Intel HT Technology			Supported		
EMT64			Supported		
Hyper-threading			Enabled		
Active Processor Cores			All		
Limit CPUID Maximum			Disabled		
Execute Disable Bit			Enabled		
Hardware Prefetcher			Enabled		
Adjacent Cache Line Prefetch			Enabled		
Intel Virtualization Technology			Disabled		
Local x2APIC			Disabled		
					→ ← Select Screen ↑ ↓ Select Item Enter: Select +- Change Field F1: General Help F2: Previous Values F3: Optimized Default F4: Save & Exit ESC: Exit

Hyper-threading

Enabled for Windows XP and Linux (OS optimized for Hyper-Threading Technology) and Disabled for other OS (OS not optimized for Hyper-Threading Technology). When Disabled, only one thread per enabled core is enabled.

Active Processor Cores

Number of cores to enable in each processor package.

Limit CPUID Maximum

Disabled for Windows XP.

Execute Disable Bit

XD can prevent certain classes of malicious buffer overflow attacks when combined with a supporting OS (Windows Server 2003 SP1, Windows XP SP2, SuSE Linux 9.2, RedHat Enterprise 3 Update 3.)

Hardware Prefetcher

To turn on/off the MLC streamer prefetcher.

Adjacent Cache Line Prefetch

To turn on/off prefetching of adjacent cache lines.

Intel Virtualization Technology

When enabled, a VMM can utilize the additional hardware capabilities provided by Vanderpool Technology

Local x2APIC

Enable Local x2APIC. Some OSES do not support this.

Shutdown Temperature Configuration

The default setting is Disabled.

Aptio Setup Utility

Main	Advanced	Chipset	Boot	Security	Save & Exit
			ACPI Shutdown Temperature	Disabled	[Enable] Provide the Standby Power for devices. [Disable] Shutdown the standby power.

SATA Configuration

SATA Device Options Settings

Aptio Setup Utility

Main	Advanced	Chipset	Boot	Security	Save & Exit
			SATA Controllers(s)	Enabled	Enable or disable SATA Device.
			SATA Mode Selection	IDE	
			Serial ATA Port 0	Empty	→ ← Select Screen ↑ ↓ Select Item Enter: Select +- Change Field F1: General Help F2: Previous Values F3: Optimized Default F4: Save & Exit ESC: Exit
			Software Preserve	Unknown	
			Serial ATA Port 1	Empty	
			Software Preserve	Unknown	
			Serial ATA Port 2	Empty	
			Software Preserve	Unknown	
			Serial ATA Port 3	Empty	
			Software Preserve	Unknown	
			Serial ATA Port 4	Empty	
			Software Preserve	Unknown	
			Serial ATA Port 5	Empty	
			Software Preserve	Unknown	

SATA Mode

Determines how SATA controllers(s) operate. The options are IDE, AHCI and RAID.

USB Configuration

USB Configuration Parameters.

Aptio Setup Utility

Main	Advanced	Chipset	Boot	Security	Save & Exit
USB Configuration					
USB Devices:					
1 Keyboard, 2 Hubs					
Legacy USB Support			Enabled		→ ← Select Screen
USB3.0 Support			Enabled		↑ ↓ Select Item
XHCI Hand-off			Enabled		Enter: Select
EHCI Hand-off			Disabled		+ - Change Field
USB hardware delays and time-outs:					F1: General Help
USB transfer time-out			20 sec		F2: Previous Values
Device reset time-out			20 sec		F3: Optimized Default
Device power-up delay			Auto		F4: Save ESC: Exit

Legacy USB Support

Enables Legacy USB support.

AUTO option disables legacy support if no USB devices are connected.

DISABLE option will keep USB devices available only for EFI applications.

USB3.0 Support

Enable/Disable USB3.0 (XHCI) Controller support.

XHCI Hand-off

This is a workaround for OSES without XHCI hand-off support. The XHCI ownership change should be claimed by XHCI driver.

EHCI Hand-off

This is a workaround for OSES without EHCI hand-off support. The EHCI ownership change should be claimed by EHCI driver.

USB transfer time-out

The time-out value for Control, Bulk, and Interrupt transfers.

Device reset time-out

USB mass storage device Start Unit command time-out.

Device power-up delay

Maximum time the device will take before it properly reports itself to the Host Controller. 'Auto' uses default value: for a Root port it is 100 ms, for a hub port the delay is taken from Hub Descriptor.

Super IO Configuration

System Super IO Chip Parameters.

Aptio Setup Utility					
Main	Advanced	Chipset	Boot	Security	Save & Exit
Super IO Configuration					→ ← Select Screen ↑ ↓ Select Item Enter: Select +- Change Field F1: General Help F2: Previous Values F3: Optimized Default F4: Save & Exit ESC: Exit
Super IO Chip		Winbond W83627DHG			
▶ Serial Port 0 Configuration					
▶ Serial Port 1 Configuration					
LVDS Backlight Level Control		[Level-1 Full-On]			
Power Failure		Always off			

Serial Port Configuration

Set Parameters of Serial Ports. User can Enable/Disable the serial port and Select an optimal settings for the Super IO Device.

Power Failure

Options are:

Keep last state

Always on

Always off (default)

H/W Monitor

Monitor hardware status.

Aptio Setup Utility

Main	Advanced	Chipset	Boot	Security	Save & Exit
PC Health Status					
Smart Fan Function			[Enabled]		
▶ Smart Fan Mode Configuration					
CPU			+45 C		
System Temperature			+47 C		
CPU FAN Speed			5976 RPM		→ ← Select Screen
VCC3V			+3.408 V		↑ ↓ Select Item
Vcore			+1.104 V		Enter: Select
+5V			+5.087 V		+ - Change Field
+12V			+12.232 V		F1: General Help
+1.5V			+1.600 V		F2: Previous Values
VSB3V			+3.384 V		F3: Optimized Default
VBAT			+3.296 V		F4: Save & Exit
					ESC: Exit

Temperatures/Voltages

These fields are the parameters of the hardware monitoring function feature of the motherboard. The values are read-only values as monitored by the system and show the PC health status.

Smart Fan Mode Configuration

This field enables (55C/60C/65C/70C) or disables the smart fan feature. At a certain temperature, the fan starts turning. Once the temperature drops to a certain level, it stops turning again.

Serial Port Console Redirection

Aptio Setup Utility

Main	Advanced	Chipset	Boot	Security	Save & Exit
COM0 (Disabled)					
Console Redirection			Port is Disabled		
COM4(PCI Dev0, Func0) (Disabled)					
Console Redirection			Port is Disabled		
Serial Port for Out-of-Band Management/					→ ← Select Screen
Windows Emergency Management Services (EMS)					↑ ↓ Select Item
Console Redirection			Enabled		Enter: Select
Out-of-Band Mgmt Port			COM0 (Disabled)		+ - Change Field
Data Bits			8		F1: General Help
Parity			None		F2: Previous Values
Stop Bits			1		F3: Optimized Default
Terminal Type			VT-UTF8		F4: Save & Exit
					ESC: Exit

Console Redirection

Console Redirection Enable/Disable.

Out-of-Band Mgmt Port

Microsoft Windows Emergency Management Services (EMS) allows for remote management of a Windows Server OS through a serial port.

Terminal Type

VT-UTF8 is the preferred terminal type for out-of-band management. The next best choice is VT100+ and then VT100.

Sandybridge DTS Configuration

Aptio Setup Utility

Main	Advanced	Chipset	Boot	Security	Save & Exit
Sadybridge DTS Configuration					→ ← Select Screen
CPU DTS			Enabled		↑ ↓ Select Item
					Enter: Select
					+ - Change Field
					F1: General Help
					F2: Previous Values
					F3: Optimized Default
					F4: Save & Exit
					ESC: Exit

CPU DTS

Disabled: ACPI thermal management uses EC reported temperature values.

Enabled: ACPI thermal management uses DTS SMM mechanism to obtain CPU temperature values.

Out of Spec: ACPI Thermal Management uses EC reported temperature values and TS SMM is used to handle Out of Spec.

Sandybridge PPM Configuration

Aptio Setup Utility

Main	Advanced	Chipset	Boot	Security	Save & Exit
Sandybridge PPM Configuration					
EIST			Enabled		
Turbo Mode			Enabled		→ ← Select Screen
CPU C3 Report			Enabled		↑ ↓ Select Item
CPU C6 Report			Enabled		Enter: Select
CPU C7 Report			Enabled		+ - Change Field
					F1: General Help
					F2: Previous Values
					F3: Optimized Default
					F4: Save & Exit
					ESC: Exit

EIST

Enable/Disable Intel SpeedStep.

Turbo Mode

Turbo Mode.

CPU C3 Report

Enable/Disable CPU C3 (ACPI C2) report to OS.

CPU C6 Report

Enable/Disable CPU C6 (ACPI C3) report to OS.

CPU C7 Report

Enable/Disable CPU C7 (ACPI C3) report to OS.

Chipset Settings

This section allows you to configure and improve your system and allows you to set up some system features according to your preference.

Aptio Setup Utility					
Main	Advanced	Chipset	Boot	Security	Save & Exit
<ul style="list-style-type: none"> ▶ System Agent (SA) Configuration ▶ PCH-IO Configuration 					

System Agent (SA) Configuration

Aptio Setup Utility					
Main	Advanced	Chipset	Boot	Security	Save & Exit
System Agent RC Version			1.1.0.0		→ ← Select Screen ↑ ↓ Select Item Enter: Select +- Change Field F1: General Help F2: Previous Values F3: Optimized Default F4: Save & Exit ESC: Exit
VT-d Capability			Supported		
VT-d			Enabled		
▶ Graphics Configuration					

VT-d

Check to enable VT-d function on MCH.

Graphics Configuration

Aptio Setup Utility

Main	Advanced	Chipset	Boot	Security	Save & Exit
Intel IGFX Configuration					
			2108		
			650 MHz		
					→ ← Select Screen
Primary Display			Auto		↑ ↓ Select Item
Internal Graphics			Auto		Enter: Select
GTT Size			2MB		+ - Change Field
Aperture Size			256MB		F1: General Help
DVMT Pre-Allocated			64M		F2: Previous Values
DVMT Total Gfx Mem			256M		F3: Optimized Default
Gfx Low Power Mode			Enabled		F4: Save & Exit
▶ LCD Control					ESC: Exit

Primary Display

Select which of IGFX/PEG/PCI Graphics device should be Primary Display Or select SG for Switchable Gfx.

Internal Graphics

Keep IGD enabled based on the setup options.

GTT Size

Select the GTT Size: 1MB, 2MB.

Aperture Size

Select the Aperture Size: 128MB, 256MB, 512MB.

DVMT Pre-Allocated

Select DVMT 5.0 Pre-Allocated (Fixed) Graphics Memory size used by the Internal Graphics Device: 0M~512M.

DVMT Total Gfx Mem

Select DVMT5.0 Total Graphic Memory size used by the Internal Graphics Device: 128M, 256M, MAX.

Gfx Low Power Mode

This option is applicable for SFF only.

LCD Control

Aptio Setup Utility

Main	Advanced	Chipset	Boot	Security	Save & Exit
LCD Control					
Primary IGFX Boot Display			VBIOS Default		
LCD Panel Type			VBIOS Default		
SDVO-LFP Panel Type			VBIOS Default		
Panel Color Depth			18 Bit		
LVDS BLON Control			[3.3V]		
Panel Scaling			Auto		
Spread Spectrum clock Chip			Off		
TV1 Standard			VBIOS Default		
TV2 Standard			VBIOS Default		
ALS Support			Enabled		
Active LFP			No LVDS		
					→ ← Select Screen ↑ ↓ Select Item Enter: Select +- Change Field F1: General Help F2: Previous Values F3: Optimized Default F4: Save & Exit ESC: Exit

Primary IGFX Boot Display

Select the Video Device that will be activated during PoST. This has no effect if external graphics present.

Secondary boot display selection will appear based on your selection. VGA modes will be supported only on primary display.

Active LFP

Select the Active LFP Configuration.

No LVDS: VBIOS does not enable LVDS.

Int-LVDS: VBIOS enables LVDS driver by Integrated encoder.

SDVO LVDS: VBIOS enables LVDS driver by SDVO encoder.

eDP Port-A: LFP Driven by Int-DisplayPort encoder from Port-A.

Panel Color Depth

Select the LFP Panel Color Depth: 18 Bit, 24 Bit.

LVDS BLON Control

Select the LFP Panel Inverted voltage: 3.3V, 5V.

LCD Panel Type

Select LCD panel used by Internal Graphics Device by selecting the appropriate setup item: 640x480 LVDS ~ 2048x1536 LVDS.

SDVO-LFP Panel Type

Select SDVO panel used by Internal Graphics Device by selecting the appropriate setup item: VBIOS Default, 1024x768 ~ 1600x1200.

Panel Scaling

Select the LCD panel scaling option used by the Internal Graphics Device: Auto, Off, Force Scaling.

Spread Spectrum clock Chip

Hardware: Spread is controlled by chip;
Software: Spread is controlled by BIOS.

TV1 Standard

Select the ability to configure a TV Format.

TV2 Standard

Select the ability to configure a TV Minor Format.

ALS Support

Valid only for ACPI.

Legacy = ALS Support though the IGD INT 10 function.

ACI = ALS support through an ACPI ALS driver.

PCH-IO Configuration

Aptio Setup Utility

Main	Advanced	Chipset	Boot	Security	Save & Exit
		Intel PCH RC Version	1.1.2.0		
		PCH LAN Controller	Enabled		
		Wake on Lan	Disabled		
		Azalia	Auto		
		Azalia Docking Support	Disabled		
		Azalia PME	Disabled		
		Azalia Internal HDMI Codec	Enabled		
		Display logic	Enabled		
		CLKRUN# logic	Enabled		
		SB CRID	Disabled		→ ← Select Screen
		High Precision Event Timer Configuration			↑ ↓ Select Item
		High Precision Timer	Enabled		Enter: Select
		SLP_S4 Assertion Width	4-5 Seconds		+ - Change Field
		Set NAND Management Override	Enabled		F1: General Help
		▶ USB Configuration			F2: Previous Values
		▶ PCI Express Configuration			F3: Optimized Default
					F4: Save & Exit
					ESC: Exit

Azalia

Control Detection of the Azalia device.

Disabled = Azalia will be unconditionally disabled.

Enabled = Azalia will be unconditionally enabled. Auto = Azalia will be enabled if present, disabled otherwise.

Set NAND Management Override

Option to Override NAND Management to allow driver or 3rd parties software to configure the NAND module after POST.

USB Configuration

Aptio Setup Utility

Main	Advanced	Chipset	Boot	Security	Save & Exit
	EHCI1		Enabled		
	EHCI2		Enabled		
	USB Ports Per-Port Disable Control		Disabled		

EHCI1

Control the USB EHCI (USB2.0) functions.

One EHCI controller must always be enabled.

PCI Express Configuration

Aptio Setup Utility

Main	Advanced	Chipset	Boot	Security	Save & Exit
		PCI Express Clock Gating	Enabled		
		DMI Link ASPM Control	L0sL1		
		DMI Link Extended Synch Control	Disabled		
		Subtractive Decode	Disabled		
		▶ PCI Express Root Port1			
		▶ PCI Express Root Port2			
		▶ PCI Express Root Port3			
		▶ PCI Express Root Port4			
		▶ PCI Express Root Port5			
		PCI Port 6 is assigned to LAN			
		▶ PCI Express Root Port7			
		▶ PCI Express Root Port8			
					→ ← Select Screen
					↑ ↓ Select Item
					Enter: Select
					+ - Change Field
					F1: General Help
					F2: Previous Values
					F3: Optimized Default
					F4: Save & Exit
					ESC: Exit

DMI Clink ASPM Control

The control of Active State Power Management on both NB side and SB side of the DMI Link.

DMI Link Extended Synch Control

The control of Extended Synch on SB side of the DMI Link.

Boot Settings

This section allows you to configure the boot settings according to your preference.

Aptio Setup Utility					
Main	Advanced	Chipset	Boot	Security	Save & Exit
Boot Configuration					
Setup Prompt Timeout			1		
Bootup NumLock State			On		
Quiet Boot			Disabled	→ ← Select Screen	
CM16 Module Version			07.64	↑ ↓ Select Item	
GateA20			Upon Request	Enter: Select	
Option ROM Messages			Force BIOS	+- Change Field	
Interrupt 19 Capture			Disabled	F1: General Help	
Boot Option Priorities				F2: Previous Values	
				F3: Optimized Default	
				F4: Save & Exit	
				ESC: Exit	

Setup Prompt Timeout

Number of seconds to wait for setup activation key. 65535(0xFFFF) means indefinite waiting.

GateA20 Active

UPON REQUEST – GA20 can be disabled using BIOS services.

ALWAYS – do not allow disabling GA20; this option is useful when any RT code is executed above 1MB.

Option ROM Messages

Set display mode for Option ROM. Options are Force BIOS and Keep Current.

Interrupt 19 Capture

Enable: Allows Option ROMs to trap Int 19.

Boot Option Priorities

Sets the system boot order.

Security Settings

This section allows you to configure and improve your system and allows you to set up some system features according to your preference.

Aptio Setup Utility					
Main	Advanced	Chipset	Boot	Security	Save & Exit
Password Description If ONLY the Administrator's password is set, then this only limits access to Setup and is only asked for when entering Setup. If ONLY the User's password is set, then this is a power on password and must be entered to boot or enter Setup. In Setup the User will have Administrator rights Administrator Password User Password		→ ← Select Screen ↑ ↓ Select Item Enter: Select +- Change Field F1: General Help F2: Previous Values F3: Optimized Default F4: Save & Exit ESC: Exit			

Administrator Password

Set Setup Administrator Password.

User Password

Set User Password.

Save & Exit Settings

Aptio Setup Utility					
Main	Advanced	Chipset	Boot	Security	Save & Exit
Save Changes and Exit Discard Changes and Exit Save Changes and Reset Discard Changes and Reset Save Options Save Changes Discard Changes Restore Defaults Save as User Defaults Restore User Defaults Boot Override Launch EFI Shell from filesystem device					→ ← Select Screen ↑ ↓ Select Item Enter: Select +- Change Field F1: General Help F2: Previous Values F3: Optimized Default F4: Save & Exit ESC: Exit

Save Changes and Exit

Exit system setup after saving the changes.

Discard Changes and Exit

Exit system setup without saving any changes.

Save Changes and Reset

Reset the system after saving the changes.

Discard Changes and Reset

Reset system setup without saving any changes.

Save Changes

Save Changes done so far to any of the setup options.

Discard Changes

Discard Changes done so far to any of the setup options.

Restore Defaults

Restore/Load Defaults values for all the setup options.

Save as User Defaults

Save the changes done so far as User Defaults.

Restore User Defaults

Restore the User Defaults to all the setup options.

Boot Override

Pressing ENTER causes the system to enter the OS.

Launch EFI Shell from filesystem device

Attempts to Launch EFI Shell application (Shellx64.efi) from one of the available filesystem devices.

Drivers Installation

This section describes the installation procedures for software and drivers. The software and drivers are included with the motherboard. If you find the items missing, please contact the vendor where you made the purchase. The contents of this section include the following:

Intel Chipset Software Installation Utility	46
VGA Drivers Installation	47
Realtek HD Audio Driver Installation.....	48
LAN Drivers Installation.....	49
ASMedia USB 3.0 Drivers.....	51

IMPORTANT NOTE:

After installing your Windows operating system, you must install first the Intel Chipset Software Installation Utility before proceeding with the drivers installation.

Intel Chipset Software Installation Utility

The Intel Chipset Drivers should be installed first before the software drivers to enable Plug & Play INF support for Intel chipset components. Follow the instructions below to complete the installation.

1. Insert the CD that comes with the board. Click **Intel** and then **Intel(R) QM67/Q67 Chipset Drivers**.



2. Click **Intel(R) Chipset Software Installation Utility**.



3. When the Welcome screen to the Intel® Chipset Device Software appears, click **Next** to continue.

4. Click **Yes** to accept the software license agreement and proceed with the installation process.

5. On the Readme File Information screen, click **Next** to continue the installation.

6. The Setup process is now complete. Click **Finish** to restart the computer and for changes to take effect.

VGA Drivers Installation

NOTE: Before installing the *Intel(R) QM67 Chipset Family Graphics Driver*, the Microsoft .NET Framework 3.5 SPI should be first installed.

To install the VGA drivers, follow the steps below.

1. Insert the CD that comes with the board. Click *Intel* and then *Intel(R) QM67/Q67 Chipset Drivers*.
2. Click *Intel(R) QM67 Chipset Family Graphics Driver*.



3. When the Welcome screen appears, click *Next* to continue.



4. Click *Yes* to agree with the license agreement and continue the installation.
5. On the Readme File Information screen, click *Next* to continue the installation of the Intel® Graphics Media Accelerator Driver.
6. On Setup Progress screen, click *Next* to continue.
7. Setup complete. Click *Finish* to restart the computer and for changes to take effect.

Realtek HD Audio Driver Installation

Follow the steps below to install the Realtek HD Audio Drivers.

1. Insert the CD that comes with the board. Click **Intel** and then **Intel(R) QM67/Q67 Chipset Drivers**.

2. Click **Realtek High Definition Audio Driver**.



3. On the Welcome to the InstallShield Wizard screen, click **Yes** to proceed with and complete the installation process.



LAN Drivers Installation

1. Insert the CD that comes with the board. Click **Intel** and then **Intel(R) QM67/Q67 Chipset Drivers**.
2. Click **Intel(R) PRO LAN Network Driver**.



3. When the Welcome screen appears, click **Next**. On the next screen, click **Yes** to agree with the license agreement.
4. Click the checkbox for **Drivers** in the Setup Options screen to select it and click **Next** to continue.

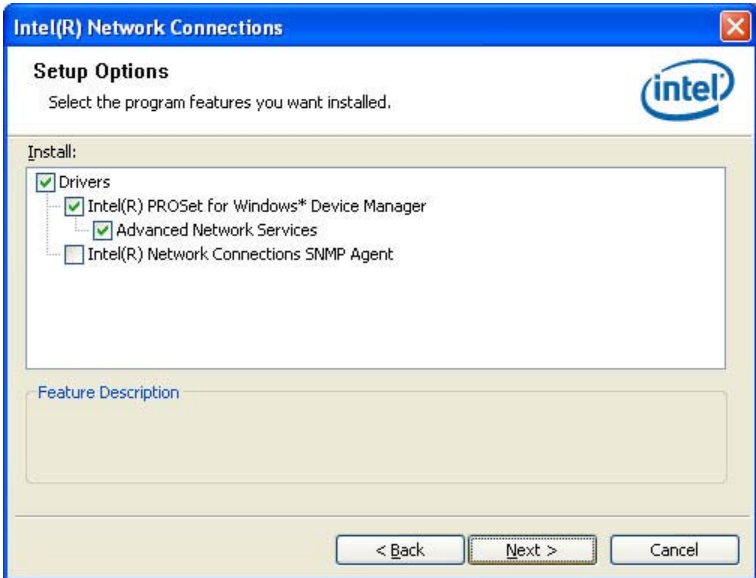

5. The wizard is ready to begin installation. Click **Install** to begin the installation.

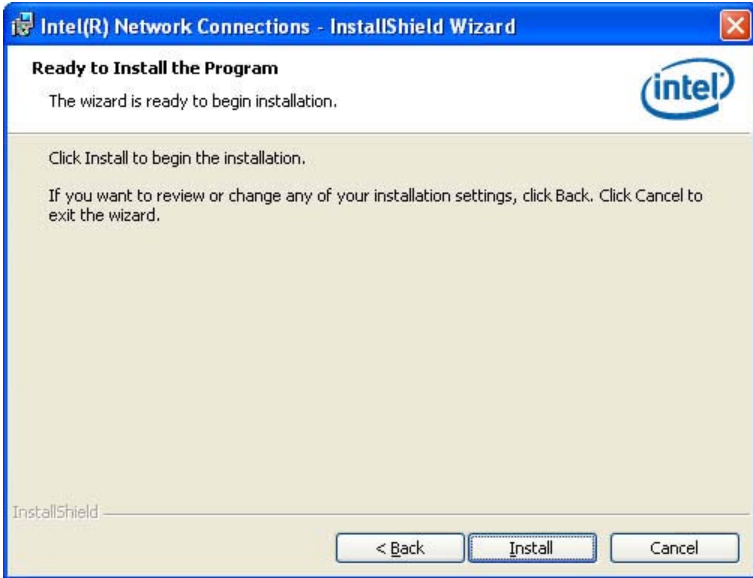

6. When InstallShield Wizard is complete, click **Finish**.

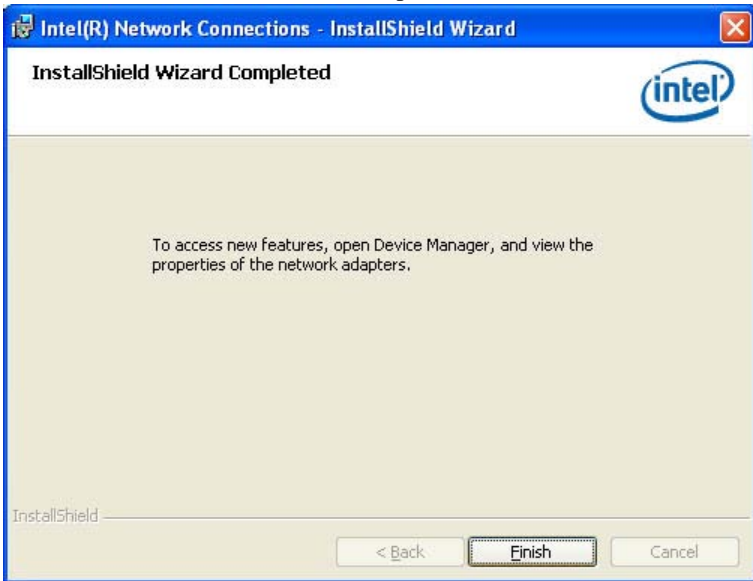

ASMedia USB 3.0 Drivers

1. Insert the CD that comes with the board. Click *Intel* and then *Intel(R) QM67/Q67 Chipset Drivers*.
2. Click *Intel(R) PRO LAN Network Driver*.



2. When the Welcome screen to the InstallShield Wizard for Intel® Management Engine Components, click *Next*.



3. When InstallShield Wizard is complete, click *Finish*.



This page is intentionally left blank.

Appendix

A. I/O Port Address Map

Each peripheral device in the system is assigned a set of I/O port addresses which also becomes the identity of the device. The following table lists the I/O port addresses used.

Address	Device Description
000h - 01Fh	DMA Controller #1
020h - 03Fh	Interrupt Controller #1
040h - 05Fh	Timer
060h - 064h	Keyboard Controller
070h - 07Fh	Real Time Clock, NMI
080h - 09Fh	DMA Page Register
0A0h - 0BFh	Interrupt Controller #2
0C0h - 0DFh	DMA Controller #2
0F0h	Clear Math Coprocessor Busy Signal
0F1h	Reset Math Coprocessor
E000-E01F	Network Connection
F060-F07F	Network Connection
F080-F0D7	SATA Storage Controller
2F8h - 2FFh	Serial Port #2(COM2)
3B0h- 3BBh	Graphics adapter Controller
3F8h - 3FFh	Serial Port #1(COM1)
3D0h - 3DFh	CGA adapter

B. Interrupt Request Lines (IRQ)

Peripheral devices use interrupt request lines to notify CPU for the service required. The following table shows the IRQ used by the devices on board.

Level	Function
IRQ0	System Timer Output
IRQ1	Keyboard
IRQ2	Interrupt Cascade
IRQ3	Serial Port #2
IRQ4	Serial Port #1
IRQ5	Reserved
IRQ6	Reserved
IRQ7	Reserved
IRQ8	Real Time Clock
IRQ9	Reserved
IRQ10	Serial Port #3
IRQ11	Serial Port #4
IRQ12	PS/2 Mouse
IRQ13	80287
IRQ14	Primary IDE
IRQ15	Secondary IDE
IRQ19	SATA Storage

C. Watchdog Timer Configuration

The WDT is used to generate a variety of output signals after a user programmable count. The WDT is suitable for use in the prevention of system lock-up, such as when software becomes trapped in a deadlock. Under these sorts of circumstances, the timer will count to zero and the selected outputs will be driven. Under normal circumstance, the user will restart the WDT at regular intervals before the timer counts to zero.

SAMPLE CODE:

```

=====
//
// THIS CODE AND INFORMATION IS PROVIDED "AS IS" WITHOUT WARRANTY OF ANY
// KIND, EITHER EXPRESSED OR IMPLIED, INCLUDING BUT NOT LIMITED TO THE
// IMPLIED WARRANTIES OF MERCHANTABILITY AND/OR FITNESS FOR A PARTICULAR
// PURPOSE.
//
=====
#include <stdio.h>
#include <stdlib.h>
#include "W627DHG.H"
=====
int main (int argc, char *argv[]);
void copyright(void);
void EnableWDT(int);
void DisableWDT(void);
=====
int main (int argc, char *argv[])
{
    unsigned char bBuf;
    unsigned char bTime;
    char **endptr;

    copyright();

    if (argc != 2)
    {
        printf(" Parameter incorrect!!\n");
        return 1;
    }

    if (Init_W627DHG() == 0)
    {
        printf(" Winbond 83627HF is not detected, program abort.\n");
        return 1;
    }
    bTime = strtol (argv[1], endptr, 10);
    printf("System will reset after %d seconds\n", bTime);

    EnableWDT(bTime);

    return 0;
}
=====

```

```

void copyright(void)
{
    printf("\n===== Winbond 83627DHG Watch Timer Tester (AUTO DETECT) =====\n")
        "      Usage : W627E_WD reset_time\n"
        "      Ex : W627E_WD 3 => reset system after 3 second\n"
        "      W627E_WD 0 => disable watch dog timer\n");
}
//=====
void EnableWDT(int interval)
{
    unsigned char bBuf;

    bBuf = Get_W627DHG_Reg( 0x2D);
    bBuf &= (!0x01);
    Set_W627DHG_Reg( 0x2D, bBuf);           //Enable WDTO

    Set_W627DHG_LD( 0x08);                //switch to logic device 8
    Set_W627DHG_Reg( 0x30, 0x01);        //enable timer

    bBuf = Get_W627DHG_Reg( 0xF5);
    bBuf &= (!0x08);
    Set_W627DHG_Reg( 0xF5, bBuf);        //count mode is second

    Set_W627DHG_Reg( 0xF6, interval);    //set timer
}
//=====
void DisableWDT(void)
{
    Set_W627DHG_LD(0x08);                //switch to logic device 8
    Set_W627DHG_Reg(0xF6, 0x00);        //clear watchdog timer
    Set_W627DHG_Reg(0x30, 0x00);        //watchdog disabled
}
//=====

```

```

//=====
//
// THIS CODE AND INFORMATION IS PROVIDED "AS IS" WITHOUT WARRANTY OF ANY
// KIND, EITHER EXPRESSED OR IMPLIED, INCLUDING BUT NOT LIMITED TO THE
// IMPLIED WARRANTIES OF MERCHANTABILITY AND/OR FITNESS FOR A PARTICULAR
// PURPOSE.
//
//=====
#include "W627DHG.H"
#include <dos.h>
//=====
unsigned int W627DHG_BASE;
void Unlock_W627DHG (void);
void Lock_W627DHG (void);
//=====
unsigned int Init_W627DHG(void)
{
    unsigned int result;
    unsigned char ucDid;

    W627DHG_BASE = 0x2E;
    result = W627DHG_BASE;

    ucDid = Get_W627DHG_Reg(0x20);
    if (ucDid == 0x88)
    {
        goto Init_Finish;
    }

    W627DHG_BASE = 0x4E;
    result = W627DHG_BASE;
    ucDid = Get_W627DHG_Reg(0x20);
    if (ucDid == 0x88)
    {
        goto Init_Finish;
    }

    W627DHG_BASE = 0x00;
    result = W627DHG_BASE;

Init_Finish:
    return (result);
}
//=====
void Unlock_W627DHG (void)
{
    outportb(W627DHG_INDEX_PORT, W627DHG_UNLOCK);
    outportb(W627DHG_INDEX_PORT, W627DHG_UNLOCK);
}
//=====
void Lock_W627DHG (void)
{
    outportb(W627DHG_INDEX_PORT, W627DHG_LOCK);
}
//=====
void Set_W627DHG_LD( unsigned char LD)
{
    Unlock_W627DHG();
    outportb(W627DHG_INDEX_PORT, W627DHG_REG_LD);
    outportb(W627DHG_DATA_PORT, LD);
    Lock_W627DHG();
}

```

APPENDIX

```
//=====
void Set_W627DHG_Reg( unsigned char REG, unsigned char DATA)
{
    Unlock_W627DHG();
    outportb(W627DHG_INDEX_PORT, REG);
    outportb(W627DHG_DATA_PORT, DATA);
    Lock_W627DHG();
}
//=====
unsigned char Get_W627DHG_Reg(unsigned char REG)
{
    unsigned char Result;
    Unlock_W627DHG();
    outportb(W627DHG_INDEX_PORT, REG);
    Result = inportb(W627DHG_DATA_PORT);
    Lock_W627DHG();
    return Result;
}
//=====

//=====
//
// THIS CODE AND INFORMATION IS PROVIDED "AS IS" WITHOUT WARRANTY OF ANY
// KIND, EITHER EXPRESSED OR IMPLIED, INCLUDING BUT NOT LIMITED TO THE
// IMPLIED WARRANTIES OF MERCHANTABILITY AND/OR FITNESS FOR A PARTICULAR
// PURPOSE.
//
//=====
#ifndef __W627DHG_H
#define __W627DHG_H                1
//=====
#define W627DHG_INDEX_PORT        (W627DHG_BASE)
#define W627DHG_DATA_PORT         (W627DHG_BASE+1)
//=====
#define W627DHG_REG_LD             0x07
//=====
#define W627DHG_UNLOCK             0x87
#define W627DHG_LOCK               0xAA
//=====
unsigned int Init_W627DHG(void);
void Set_W627DHG_LD( unsigned char);
void Set_W627DHG_Reg( unsigned char, unsigned char);
unsigned char Get_W627DHG_Reg( unsigned char);
//=====
#endif // __W627DHG_H
```