

# **IB745**

Full-Size Socket 370  
Intel 815E(B) CPU Card

## **USER'S MANUAL**

Version 1.0

---

## **Acknowledgments**

Award is a registered trademark of Award Software International, Inc.

PS/2 is a trademark of International Business Machines Corporation.

Intel, Celeron, and Pentium III are registered trademarks of Intel Corporation.

Microsoft Windows is a registered trademark of Microsoft Corporation.

Winbond is a registered trademark of Winbond Electronics Corporation.

All other product names or trademarks are properties of their respective owners.

---

# Table of Contents

<b>Introduction.....</b>	<b>1</b>
Product Description .....	1
Checklist.....	2
Specifications.....	3
Board Dimensions.....	4
<b>Installations .....</b>	<b>5</b>
Installing the CPU.....	6
MicroPCI Daughter Card Installation .....	7
Installing the Memory (DIMM) .....	8
Setting the Jumpers.....	9
Connectors on IB745 .....	14
<b>BIOS Setup.....</b>	<b>27</b>
<b>Drivers Installation .....</b>	<b>47</b>
Windows 98 Drivers Installation .....	48
Windows NT 4.0 Drivers Installation .....	61
Windows 2000 Drivers Installation .....	70
<b>Appendix .....</b>	<b>75</b>
A. I/O Port Address Map.....	75
B. Interrupt Request Lines (IRQ) .....	76

---

This page was intentionally left blank.

# Introduction

## Product Description

---

IB745 is a high-performance flexible CPU card that comes with one built-in MicroPCI socket that supports MicroPCI daughter cards with VGA, VGA/LAN, Ethernet (LAN), SCSI, and IEEE 1394 functions.

IB745 is based on the Intel 815E(B) chipset that contains the Graphics and Memory Controller Hub (GMCH), the I/O Controller Hub (ICH2) and the Firmware Hub (FWH). It supports 66/100/133MHz system bus, up to 1.2GHz CPU speed, integrated 2D/3D graphics accelerator, and 100/133MHz SDRAM modules. With the ICH2, it is able to support UDMA/100, four USB ports, and integrated LAN.

System memory is provided by three 168-pin DIMM sockets\* that accommodates SDRAM with a maximum capacity of 512MB. The Award BIOS facilitates easy system configuration and peripheral setup. Other advanced features include *DiskOnChip flash disk support*, 256-level watchdog timer (supported by LPC I/O IT8712), and IrDA interface.

*DiskOnChip flash disks* are storage devices that has no moving parts and emulates FDD/HDD with Flash/RAM/ROM offering reliable data/program storage and long life span. They are reliable and suitable for industrial or other harsh environments characterized by motion, shock, vibration, adverse temperature, dust and humidity. Other features include faster data access, longer MTBF, lower power consumption, cost effective for small capacity and small form factor.

*\* Using double-sided PC133 modules, only two modules can be inserted in the DIMM sockets.*

## Checklist

---

---

Your IB745 package should include the items listed below.

- The IB745 Industrial CPU Card
- This User's Manual
- 1 IDE Ribbon Cable
- 1 Floppy Ribbon Connector
- 2 Serial Port Ribbon Cable and 1 Parallel Port Attached to a Mounting Bracket
- 1 Y-Cable supporting a PS/2 Keyboard and a PS/2 Mouse
- 1 CD containing the following:
  - Chipset Drivers
  - Flash Memory Utility

## Specifications

<b>Processor Supported</b>	Socket 370 support Intel Celeron / Pentium III (Coppermine/Tualatin), 533MHz~1.2GHz, 66/100/133MHz Bus Speed
<b>Chipset</b>	Intel 815E(B) Chipset
<b>BIOS</b>	Award BIOS Supports ACPI, DMI, PnP
<b>System Memory</b>	3x DIMM sockets support up to 512MB capacity PC100/PC133 supported
<b>LPC I/O Chipset</b>	ITE IT8712 (keyboard controller is built-in)
<b>I/O Features</b>	1x FDD (up to 2.88MB, 3 Mode, LS120) 1x Parallel Port (EPP, ECP Port) 2x Serial Ports (1x RS232 and 1x RS232/422/485) 1x IrDA TX/RX Headers
<b>Bus Master IDE</b>	2x IDE interfaces for up to 4 devices; supports PIO Mode 3/4 or UDMA/33/66/100 HDD, and ATAPI CD-ROM
<b>VGA</b>	815E(B) integrated graphics Shared memory Optional 4MB display cached on board Optional TMDS LCD (SiI164) with 24-pin DVI-D connector
<b>LAN</b>	ICH2 integrated Ethernet controller 10Base-T / 100Base-TX protocol Optional Dual Ethernet solution via MicroPCI socket
<b>Hardware Monitoring</b>	Built-in IT8712 Monitors CPU/system temperature and voltages
<b>SSD Interface</b>	Support M-Systems 2MB~144MB DiskOnChip flash disk
<b>MicroPCI Socket</b>	One MicroPCI socket supports MicroPCI daughter cards with VGA, Ethernet, SCSI or IEEE 1394 functions.
<b>Other Features</b>	Pin header for 4 USB ports 256-level Watchdog timer ISA high drive PICMG compliance
<b>Form Factor</b>	Full Size
<b>Dimensions</b>	338mm x 122mm (13.3" x 4.8")

# Board Dimensions

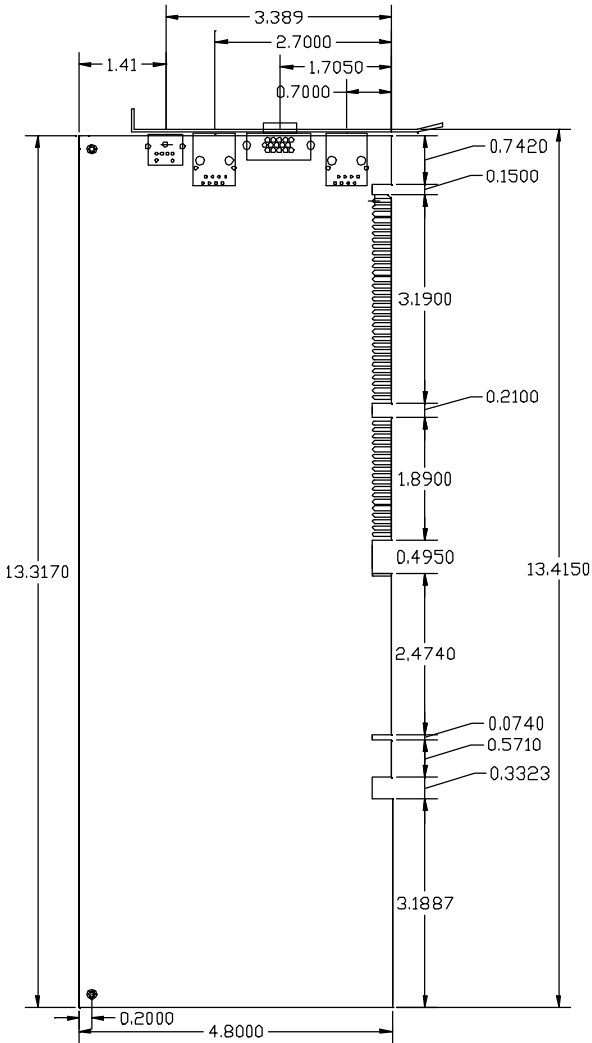



---

## Installations

This section provides information on how to use the jumpers and connectors on the IB745 in order to set up a workable system. The topics covered are:

Installing the CPU.....	6
MicroPCI Daughter Card Installation .....	7
Installing the Memory (DIMM) .....	8
Setting the Jumpers.....	9
Connectors on IB745 .....	14

## Installing the CPU

---

The IB745 CPU Card supports a Socket 370 processor socket for Intel Pentium III (Coppermine/Tualatin) and Celeron processors.

The Socket 370 processor socket comes with a lever to secure the processor. Raise this lever to about a 90° angle to allow the insertion of the processor. Place the processor into the socket by making sure the notch on the corner of the CPU corresponds with the notch on the inside of the socket. Once the processor has slide into the socket, return the lever to the lock position. Refer to the figures below.

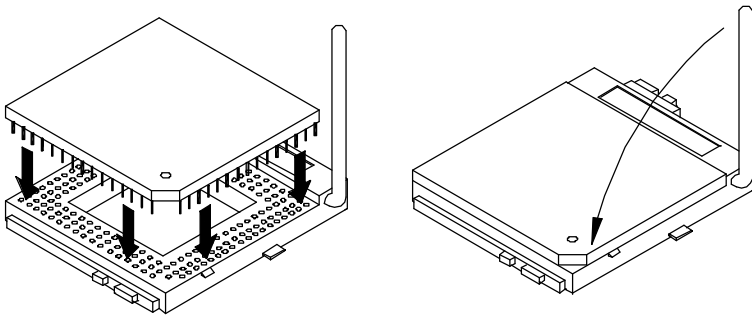

After you have installed the processor into the socket, check if the jumpers for the CPU type and speed are correct.

**NOTE:** *Ensure that the CPU heat sink and the CPU top surface are in total contact to avoid CPU overheating problem that would cause your system to hang or be unstable.*

---

## MicroPCI Daughter Card Installation

---

The IB745 CPU card is integrated with a **MicroPCI socket** that use SO-DIMM 144-pin connectors. These sockets can accommodate the optional MicroPCI daughter cards.

To insert the MicroPCI daughter cards, position it at 30° to the PCB and gently push it into the MicroPCI connector (See Figure 1 below). The card will not fit when inserted at an angle of 45° or 15°. Once inserted, slowly press the card towards the PCB until it locks on both sides to the clips of the connector. Screw the card to the PCB to secure the installation. To remove the MicroPCI card, pull the 'clips' sideways as shown in Figure 2 below.

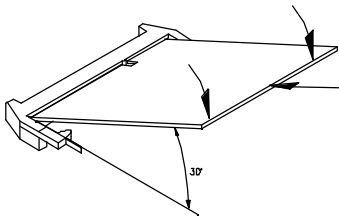

Figure 1.

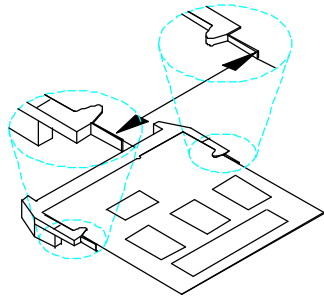

Figure 2.

## Installing the Memory (DIMM)

---

The IB745 CPU Card supports three 168-pin DIMM sockets for a maximum total memory of 512MB in SDRAM type. The memory module capacities supported are 32MB, 64MB, 128MB and 256MB.

*Note: When using double-sided PC133 SDRAM modules, insert only up to two modules into the DIMM sockets. Inserting three of these modules will*

### Installing and Removing DIMMs

To install the DIMM, locate the memory slot on the CPU card and perform the following steps:

1. Hold the DIMM so that the two keys of the DIMM align with those on the memory slot.
2. Gently push the DIMM in an upright position until the clips of the slot close to hold the DIMM in place when the DIMM touches the bottom of the slot.
3. To remove the DIMM, press the clips with both hands.

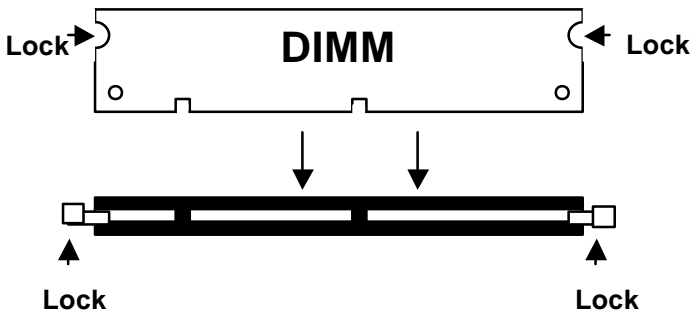

Top View of DIMM Socket

---

## Setting the Jumpers

---

Jumpers are used on IB745 to select various settings and features according to your needs and applications. Contact your supplier if you have doubts about the best configuration for your needs. The following lists the connectors on IB745 and their respective functions.

Jumper Locations on IB745.....	10
Configuring the CPU Frequency .....	11
JP11, JP12: CPU Overclocking.....	11
JP1: BIOS Write Protect .....	11
JP2, JP3, JP4: RS232/422/485 (COM2) Selection .....	12
JP7: Clear CMOS Contents .....	12
JP13: DiskOnChip Address Select.....	12
JP14: Clear Keyboard Password.....	13
JP16, JP17, JP18, JP19, JP20: CRT VGA Signal Select .....	13

### Jumper Locations on IB745

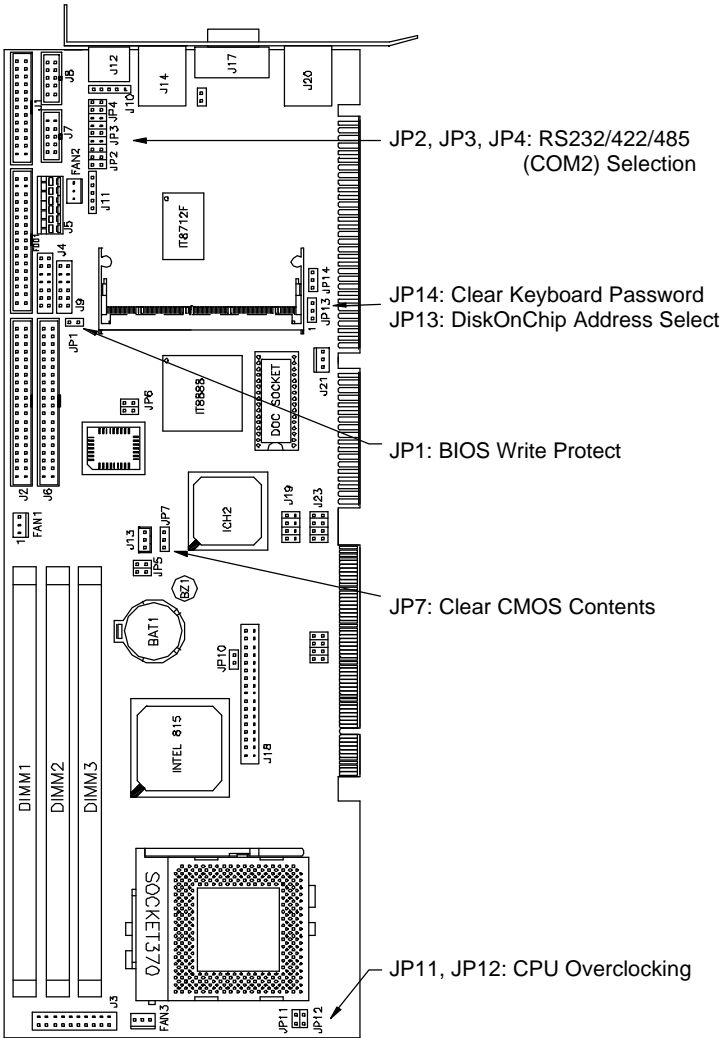







### Configuring the CPU Frequency

The IB745 CPU card does not provide DIP switches to configure the processor speed (CPU frequency). However, the processor speed can be configured inside the BIOS Setup. Refer to the BIOS Setup section in this manual on how to change the processor speed.



### JP11, JP12: CPU Overclocking

Use JP11 and JP12 2-pin jumpers when overclocking the CPU bus speed from 66MHz to 100MHz or 100MHz to 133MHz. Refer to the table below. Note that some processors cannot be overclocked because their bus speed has been 'locked' by the manufacturer and overclocking can cause the system to hang or become unstable.

Jumper	Normal	66→100MHz	100→133MHz
JP11	 SHORT	 SHORT	 OPFN
JP12	 SHORT	 OPFN	 SHORT

### JP1: BIOS Write Protect

JP1 can be used to protect the BIOS from being overwritten due to accidental modification or virus attacks.

JP1	Write Protect
 SHORT	Enabled
 OPFN	Disabled

**JP2, JP3, JP4: RS232/422/485 (COM2) Selection**

COM1 is fixed for RS-232 use only.

COM2 is selectable for RS232, RS-422 and RS-485.

The following table describes the jumper settings for COM2 selection.

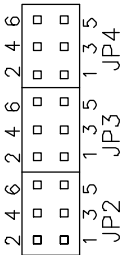

COM2 Function	RS-232	RS-422	RS-485
Jumper Setting (pin closed)	JP2: 1-2	JP2: 3-4	JP2: 5-6
	JP3: 3-5 & 4-6	JP3: 1-3 & 2-4	JP3: 1-3 & 2-4
	JP4: 3-5 & 4-6	JP4: 1-3 & 2-4	JP4: 1-3 & 2-4

**JP7: Clear CMOS Contents**

Use JP7, a 3-pin header, to clear the CMOS contents. *Note that the ATX-power connector should be disconnected from the CPU card before clearing CMOS.*

JP7	Setting	Function
 1 2 3	Pin 1-2 Short/Closed	Normal
 1 2 3	Pin 2-3 Short/Closed	Clear CMOS



**JP13: DiskOnChip Address Select**

JP13	Address
 1 2 3	D0000-D7FFF
 1 2 3	D8000-DFFFF (default)





**JP14: Clear Keyboard Password**

JP14, a 3-pin header, can be used to clear the keyboard password when you have forgotten the keyboard password configured in the BIOS Setup. After clearing the keyboard password, you can then turn on the system through the power button.

JP14	Function
 1 2 3	Normal
 1 2 3	Clear keyboard password

**JP16, JP17, JP18, JP19, JP20: CRT VGA Signal Select**

Use JP16, JP17, JP18, JP19, and JP20 to select the CRT VGA signal, either from the on board VGA or from an optional MicroPCI VGA.

JP16/17/18/19/20	Function
 1 2 3	MicroPCI VGA
 1 2 3	On Board VGA

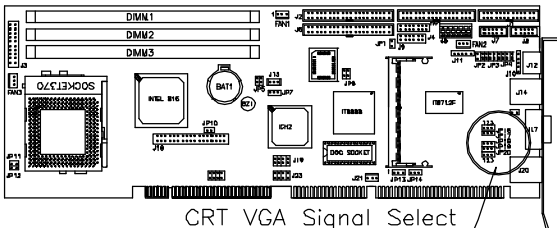

CRT VGA Signal Select  
 2-3 SHORT: On board VGA Signal  
 1-2 SHORT: MicroPCI VGA Signal

## Connectors on IB745

---

The connectors on IB745 allows you to connect external devices such as keyboard, floppy disk drives, hard disk drives, printers, etc. The following table lists the connectors on IB745 and their respective functions.

Connector Locations on IB745.....	15
J1: Parallel Port Connector.....	16
FDD1: Floppy Drive Connector.....	16
J2, J6: EIDE Connectors.....	17
J3: System Function Connector.....	18
FAN1: System Fan Power Connector.....	20
FAN2: Auxiliary Fan Power Connector.....	20
FAN3: CPU Fan Power Connector.....	20
J4: Smart Card Reader Interface.....	21
J5: P8 AT Power Connector.....	21
J7, J8: COM1, COM2 Serial Port.....	21
J9: External Audio Connector.....	22
J10: External PS/2 Keyboard and Mouse Connector.....	22
J11: IrDA Connector.....	23
J12: PS/2 Keyboard and Mouse Connector.....	23
J13: Wake On LAN Connector.....	23
J14, J20: Primary and Secondary RJ45 Connector.....	23
J17: VGA CRT Connector.....	24
J18: TMDS Panel Connector.....	24
J19, J23: USB Connectors.....	25
J21: External ATX Power Connector.....	25

## Connector Locations on IB745

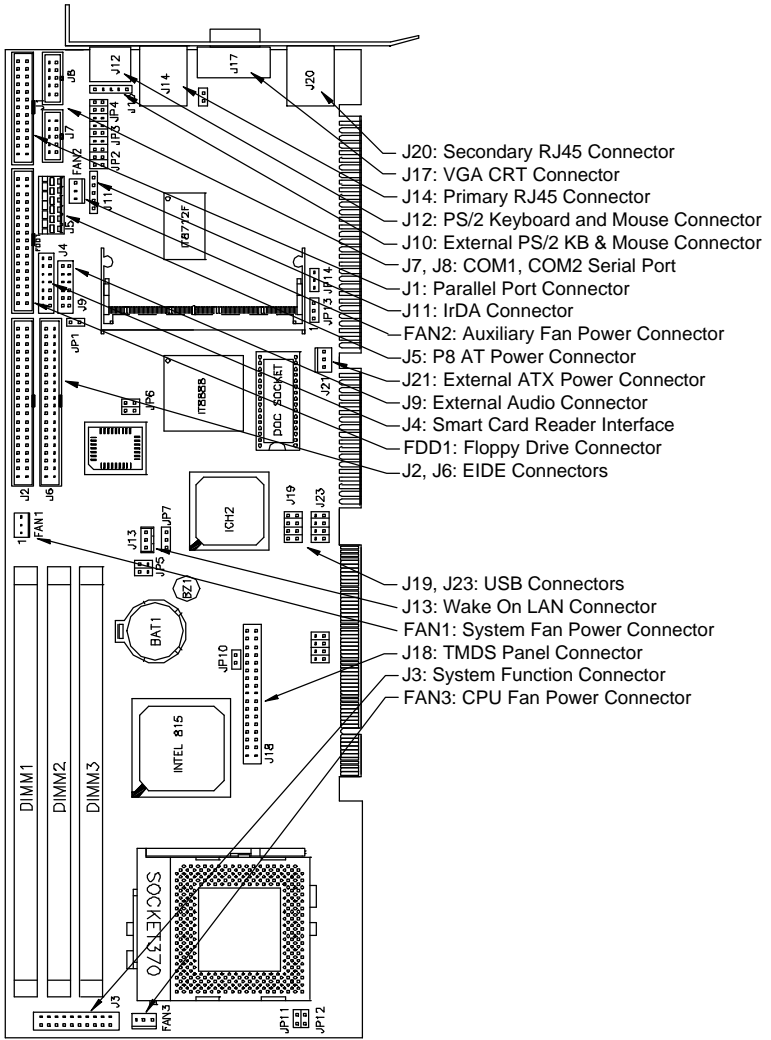

**J1: Parallel Port Connector**

The following table describes the pin out assignments of this connector.

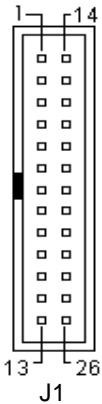

Signal Name	Pin #	Pin #	Signal Name
Line printer strobe	1	14	AutoFeed
PD0, parallel data 0	2	15	Error
PD1, parallel data 1	3	16	Initialize
PD2, parallel data 2	4	17	Select
PD3, parallel data 3	5	18	Ground
PD4, parallel data 4	6	19	Ground
PD5, parallel data 5	7	20	Ground
PD6, parallel data 6	8	21	Ground
PD7, parallel data 7	9	22	Ground
ACK, acknowledge	10	23	Ground
Busy	11	24	Ground
Paper empty	12	25	Ground
Select	13	N/A	N/A

**FDD1: Floppy Drive Connector**

FDD1 is a 34-pin header and will support up to 2.88MB floppy drives.

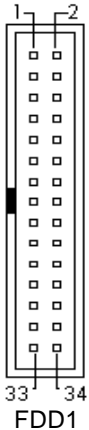

Signal Name	Pin #	Pin #	Signal Name
Ground	1	2	RM/LC
Ground	3	4	No connect
Ground	5	6	No connect
Ground	7	8	Index
Ground	9	10	Motor enable 0
Ground	11	12	Drive select 1
Ground	13	14	Drive select 0
Ground	15	16	Motor enable 1
Ground	17	18	Direction
Ground	19	20	Step
Ground	21	22	Write data
Ground	23	24	Write gate
Ground	25	26	Track 00
Ground	27	28	Write protect
Ground	29	30	Read data
Ground	31	32	Side 1 select
Ground	33	34	Diskette change

**J2, J6: EIDE Connectors**

**J2: Primary IDE Connector**

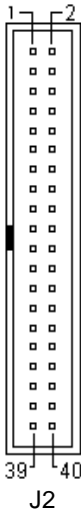

Signal Name	Pin #	Pin #	Signal Name
Reset IDE	1	2	Ground
Host data 7	3	4	Host data 8
Host data 6	5	6	Host data 9
Host data 5	7	8	Host data 10
Host data 4	9	10	Host data 11
Host data 3	11	12	Host data 12
Host data 2	13	14	Host data 13
Host data 1	15	16	Host data 14
Host data 0	17	18	Host data 15
Ground	19	20	Protect pin
DRQ0	21	22	Ground
Host IOW	23	24	Ground
Host IOR	25	26	Ground
IOCHRDY	27	28	Host ALE
DACK0	29	30	Ground
IRQ14	31	32	No connect
Address 1	33	34	No connect
Address 0	35	36	Address 2
Chip select 0	37	38	Chip select 1
Activity	39	40	Ground

**J6: Secondary IDE Connector**

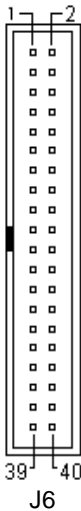

Signal Name	Pin #	Pin #	Signal Name
Reset IDE	1	2	Ground
Host data 7	3	4	Host data 8
Host data 6	5	6	Host data 9
Host data 5	7	8	Host data 10
Host data 4	9	10	Host data 11
Host data 3	11	12	Host data 12
Host data 2	13	14	Host data 13
Host data 1	15	16	Host data 14
Host data 0	17	18	Host data 15
Ground	19	20	Protect pin
DRQ1	21	22	Ground
Host IOW	23	24	Ground
Host IOR	25	26	Ground
IOCHRDY	27	28	Host ALE
DACK1	29	30	Ground
IRQ15	31	32	No connect
Address 1	33	34	No connect
Address 0	35	36	Address 2
Chip select 0	37	38	Chip select 1
Activity	39	40	Ground

### J3: System Function Connector

J3 provides connectors for system indicators that provide light indication of the computer activities and switches to change the computer status. J3 is a 20-pin header that provides interfaces for the following functions.

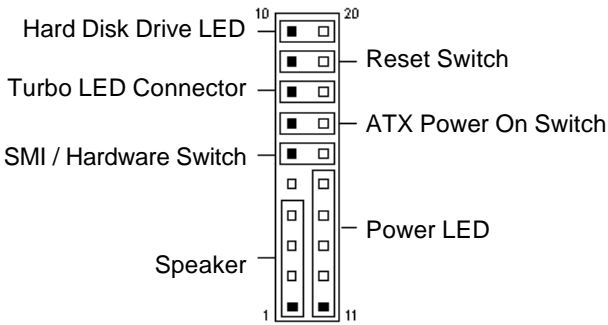

#### Speaker: Pins 1 - 4

This connector provides an interface to a speaker for audio tone generation. An 8-ohm speaker is recommended.



Pin #	Signal Name
1	Speaker out
2	No connect
3	Ground
4	+5V

#### Power LED: Pins 11 - 15

The power LED indicates the status of the main power switch.



Pin #	Signal Name
11	Power LED
12	No connect
13	Ground
14	No connect
15	Ground

**SMI/Hardware Switch: Pins 6 and 16**

This connector supports the "Green Switch" on the control panel, which, when pressed, will force the system into the power-saving mode immediately.

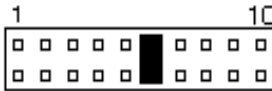

Pin #	Signal Name
6	Sleep
16	Ground

**ATX Power ON Switch: Pins 7 and 17**

This 2-pin connector is an "ATX Power Supply On/Off Switch" on the system that connects to the power switch on the case. When pressed, the power switch will force the system to power on. When pressed again, it will force the system to power off.

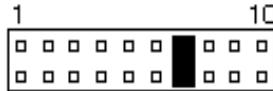

**Turbo LED Connector: Pins 8 and 18**

There is no turbo/deturbo function on the CPU card. The Turbo LED on the control panel will always be On when attached to this connector.

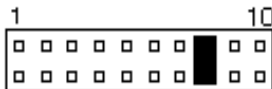

Pin #	Signal Name
8	5V
18	Ground

**Reset Switch: Pins 9 and 19**

The reset switch allows the user to reset the system without turning the main power switch off and then on again. Orientation is not required when making a connection to this header.

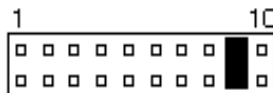

**Hard Disk Drive LED Connector: Pins 10 and 20**

This connector connects to the hard drive activity LED on control panel. This LED will flash when the HDD is being accessed.

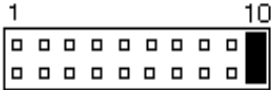

Pin #	Signal Name
10	Ground
20	5V

**FAN1: System Fan Power Connector**

FAN1 is a 3-pin header for the system fan. The fan must be a 12V fan.

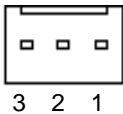

Pin #	Signal Name
1	Ground
2	+12V
3	Rotation detection

**FAN2: Auxiliary Fan Power Connector**

FAN2 is a 3-pin header for a 12V fan.

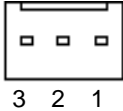

Pin #	Signal Name
1	Ground
2	+12V
3	Rotation detection

**FAN3: CPU Fan Power Connector**

FAN3 is a 3-pin header for the CPU fan. The fan must be a 12V fan.

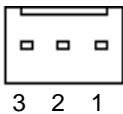

Pin #	Signal Name
1	Ground
2	+12V
3	Rotation detection



**J4: Smart Card Reader Interface**

J4 is a 14-pin header that provides interface for a Smart Card Reader. The table below shows the pin assignments of this pin header.

	<b>Signal Name</b>	<b>Pin #</b>	<b>Pin #</b>	<b>Signal Name</b>
	+5V	1	2	Protect pin
	No connect	3	4	No connect
	-SCRFET	5	6	SCRRST
	SCRCLK	7	8	No connect
	No connect	9	10	SCRIO
	Ground	11	12	-SCRPRES
No connect	13	14	No connect	

**J5: P8 AT Power Connector**

	<b>Pin #</b>	<b>Signal Name</b>
	1	N.C.
	2	+5V
	3	+12V
	4	-12V
	5	Ground
6	Ground	

**J7, J8: COM1, COM2 Serial Port**

J7 and J8 both 10-pin headers, are the onboard serial port connectors of the IB745. The following table shows the pin assignments of these connectors.

<p>J7 fixed as RS-232</p> <p>J8 Configurable as RS-232/ RS-422/485 with jumpers JP2/JP3/JP4</p>	<b>Pin #</b>	<b>Signal Name</b>		
		<b>RS-232</b>	<b>RS-422</b>	<b>RS-485</b>
	1	DCD	TX-	DATA-
	2	RX	TX+	DATA+
	3	TX	RX+	NC
	4	DTR	RX-	NC
	5	GND	GND	GND
	6	DSR	RTS-	NC
	7	RTS	RTS+	NC
	8	CTS	CTS+	NC
9	RI	CTS-	NC	
10	NC	NC	NC	

**J9: External Audio Connector**

J9 is a 12-pin header that is used to connect to the IB741 daughter card that integrates jacks for Line In, Line Out and Speaker.

1	□	2	<b>Signal Name</b>	<b>Pin #</b>	<b>Pin #</b>	<b>Signal Name</b>
	□		LINEOUT L	1	2	LINEOUT R
	□		LINEIN L	3	4	LINEIN R
	□		Ground	5	6	Ground
	□		CDIN_L	7	8	CDIN_R
11	□	12	VREFOUT	9	10	CDGND
	□		MIC	11	12	Protect pin

**J10: External PS/2 Keyboard and Mouse Connector**

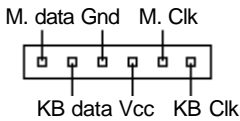

Pin #	Signal Name
1	Mouse data
2	KB data
3	Ground
4	Vcc
5	Mouse Clock
6	KB Clock

Please take note of the pin number orientation of this connector to avoid possible damage to the keyboard due to wrong insertion. Also shown below is the external keyboard cable connecting from the CPU card to a backplane's keyboard connector.

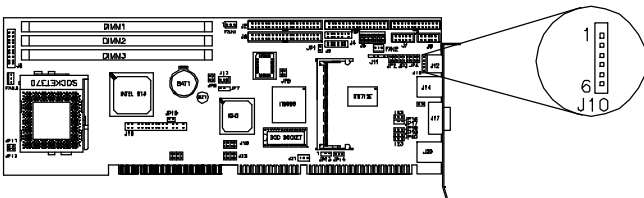

**J11: IrDA Connector**

J11 is used for an optional IrDA connector for wireless communication.

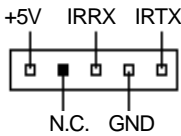

Pin #	Signal Name
1	+5V
2	No connect
3	Ir RX
4	Ground
5	Ir TX

**J12: PS/2 Keyboard and Mouse Connector**

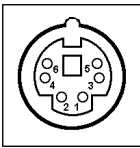

J12

Pin #	Signal Name
1	Mouse data
2	Keyboard data
3	Ground
4	Vcc
5	Mouse Clock
6	Keyboard Clock

**J13: Wake On LAN Connector**

J13 is a 3-pin header for the Wake On LAN function on the CPU card. The following table shows the pin out assignments of this connector. Wake On LAN will function properly only with an ATX power supply with 5VSB that has 200mA.

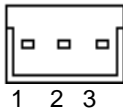

Pin #	Signal Name
1	+5VSB
2	Ground
3	-PME

**J14, J20: Primary and Secondary RJ45 Connector**

J14 and J20 are the primary RJ-45 and secondary RJ-45 connectors respectively. The J20 secondary RJ-45 connector is used in conjunction with a secondary Ethernet provided through a MicroPCI Ethernet card. The figure below shows the pin out assignments of the connector and its corresponding input jack.

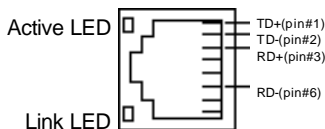

**J17: VGA CRT Connector**

The pin assignments of the J17 VGA CRT connector are as follows:

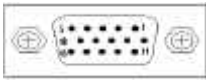

J17

Signal Name	Pin	Pin	Signal Name
Red	1	2	Green
Blue	3	4	N.C.
GND	5	6	GND
GND	7	8	GND
N.C.	9	10	GND
N.C.	11	12	N.C.
HSYNC	13	14	VSYNC
NC	15		

**J18: TMDS Panel Connector**

TMDS stands Transition Minimized Differential Signaling. J18 TMDS panel connector is to be connected to the optional IB741 daughter card. The table below shows the pin assignments of this connector.

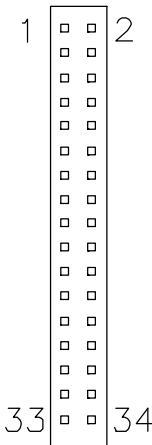

J18

Signal Name	Pin #	Pin #	Signal Name
+5V	1	2	+3.3V
Ground	3	4	Ground
D1	5	6	D0
D3	7	8	D2
D5	9	10	D4
D7	11	12	D6
D9	13	14	D8
D11	15	16	D10
+3.3V	17	18	+3.3V
-PCIRST	19	20	Ground
BLANK#	21	22	HSYNC
Ground	23	24	VSYNC
3VFTSCL	25	26	Protect pin
3VFTSDA	27	28	5VFTSDA
+1.8V	29	30	5VFTSCL
CLK0	31	32	Ground
CLK1	33	34	SL_STALL

**J19, J23: USB Connectors**

The following table shows the pin outs of the USB pin headers connectors. Overall, the two pin headers support four USB ports.

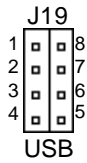

Signal Name	Pin	Pin	Signal Name
Vcc	1	8	Ground
USB0-	2	7	USB1+
USB0+	3	6	USB1-
Ground	4	5	Vcc

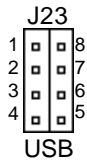

Signal Name	Pin	Pin	Signal Name
Vcc	1	8	Ground
USB2-	2	7	USB3+
USB2+	3	6	USB3-
Ground	4	5	Vcc

**J21: External ATX Power Connector**

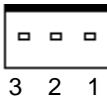

Pin #	Signal Name
1	Ground
2	PS-ON (soft on/of)
3	5VSB (Standby +5V)

This page was intentionally left blank.

---

# BIOS Setup

This chapter describes the different settings available in the Award BIOS that comes with the CPU card. The topics covered in this chapter are as follows:

BIOS Introduction .....	28
BIOS Setup.....	28
Standard CMOS Setup.....	30
Advanced BIOS Features.....	33
Advanced Chipset Features .....	36
Integrated Peripherals .....	38
Power Management Setup.....	41
PNP/PCI Configurations.....	43
PC Health Status.....	44
Frequency/Voltage Control.....	45
Load Fail-Safe Defaults .....	46
Load Setup Defaults .....	46
Set Supervisor/User Password.....	46
Save & Exit Setup.....	46
Exit Without Saving .....	46

## BIOS Introduction

The Award BIOS (Basic Input/Output System) installed in your computer system's ROM supports Intel Pentium II/III processors. The BIOS provides critical low-level support for a standard device such as disk drives, serial ports and parallel ports. It also adds virus and password protection as well as special support for detailed fine-tuning of the chipset controlling the entire system.

## BIOS Setup

The Award BIOS provides a Setup utility program for specifying the system configurations and settings. The BIOS ROM of the system stores the Setup utility. When you turn on the computer, the Award BIOS is immediately activated. Pressing the <Del> key immediately allows you to enter the Setup utility. If you are a little bit late pressing the <Del> key, POST (Power On Self Test) will continue with its test routines, thus preventing you from invoking the Setup. If you still wish to enter Setup, restart the system by pressing the "Reset" button or simultaneously pressing the <Ctrl>, <Alt> and <Delete> keys. You can also restart by turning the system Off and back On again. The following message will appear on the screen:

```
Press <DEL> to Enter Setup
```

In general, you press the arrow keys to highlight items, <Enter> to select, the <PgUp> and <PgDn> keys to change entries, <F1> for help and <Esc> to quit.

When you enter the Setup utility, the Main Menu screen will appear on the screen. The Main Menu allows you to select from various setup functions and exit choices.



CMOS Setup Utility – Copyright ©1984-2000 Award Software

Standard CMOS Features	Frequency/Voltage Control
Advanced BIOS Features	Load Fail-Safe Defaults
Advanced Chipset Features	Load Optimized Defaults
Integrated Peripherals	Set Supervisor Password
Power Management Setup	Set User Password
PnP/PCI Configurations	Save & Exit Setup
PC Health Status	Exit Without Saving
ESC : Quit	↑ ↓ → ← : Select Item
F10 : Save & Exit Setup	
Time, Date, Hard Disk Type...	

The section below the setup items of the Main Menu displays the control keys for this menu. At the bottom of the Main Menu just below the control keys section, there is another section which displays information on the currently highlighted item in the list.

**Note:** *If the system cannot boot after making and saving system changes with Setup, the Award BIOS supports an override to the CMOS settings that resets your system to its default.*

**Warning:** *It is strongly recommended that you avoid making any changes to the chipset defaults. These defaults have been carefully chosen by both Award and your system manufacturer to provide the absolute maximum performance and reliability. Changing the defaults could cause the system to become unstable and crash in some cases.*

## Standard CMOS Setup

“Standard CMOS Setup” choice allows you to record some basic hardware configurations in your computer system and set the system clock and error handling. If the CPU card is already installed in a working system, you will not need to select this option. You will need to run the Standard CMOS option, however, if you change your system hardware configurations, the onboard battery fails, or the configuration stored in the CMOS memory was lost or damaged.

CMOS Setup Utility – Copyright ©1984-2000 Award Software  
Standard CMOS Features

		Item Help
Date (mm:dd:yy)	Tue, Mar 26 2000	Menu Level
Time (hh:mm:ss)	00 : 00 : 00	
IDE Primary Master	Press Enter 13020 MB	Change the day, month, Year and century
IDE Primary Slave	Press Enter None	
IDE Secondary Master	Press Enter None	
IDE Secondary Slave	Press Enter None	
Drive A	1.44M, 3.5 in.	
Drive B	None	
Video	EGA/VGA	
Halt On	All Errors	
Base Memory	640K	
Extended Memory	129024K	
Total Memory	130048K	

At the bottom of the menu are the control keys for use on this menu. If you need any help in each item field, you can press the <F1> key. It will display the relevant information to help you. The memory display at the lower right-hand side of the menu is read-only. It will adjust automatically according to the memory changed. The following describes each item of this menu.

### Date

The date format is:

**Day :** Sun to Sat  
**Month :** 1 to 12  
**Date :** 1 to 31  
**Year :** 1994 to 2079

To set the date, highlight the “Date” field and use the PageUp/ PageDown or +/- keys to set the current time.

**Time**

The time format is: **Hour : 00 to 23**  
**Minute : 00 to 59**  
**Second : 00 to 59**

To set the time, highlight the "Time" field and use the <PgUp>/<PgDn> or +/- keys to set the current time.

**IDE Primary HDDs / IDE Secondary HDDs**

The onboard PCI IDE connectors provide Primary and Secondary channels for connecting up to four IDE hard disks or other IDE devices. Each channel can support up to two hard disks; the first is the "Master" and the second is the "Slave".

Press <Enter> to configure the hard disk. The selections include Auto, Manual, and None. Select 'Manual' to define the drive information manually. You will be asked to enter the following items.

**CYLS :** Number of cylinders  
**HEAD :** Number of read/write heads  
**PRECOMP :** Write precompensation  
**LANDZ :** Landing zone  
**SECTOR :** Number of sectors

The Access Mode selections are as follows:

Auto  
Normal (HD < 528MB)  
Large (for MS-DOS only)  
LBA (HD > 528MB and supports  
Logical Block Addressing)

**Drive A / Drive B**

These fields identify the types of floppy disk drive A or drive B that has been installed in the computer. The available specifications are:

360KB 1.2MB 720KB 1.44MB 2.88MB  
5.25 in. 5.25 in. 3.5 in. 3.5 in. 3.5 in.

### Video

This field selects the type of video display card installed in your system. You can choose the following video display cards:

EGA/VGA	For EGA, VGA, SEGA, SVGA or PGA monitor adapters. (default)
CGA 40	Power up in 40 column mode.
CGA 80	Power up in 80 column mode.
MONO	For Hercules or MDA adapters.

### Halt On

This field determines whether or not the system will halt if an error is detected during power up.

No errors	The system boot will not be halted for any error that may be detected.
All errors	Whenever the BIOS detects a non-fatal error, the system will stop and you will be prompted.
All, But Keyboard	The system boot will not be halted for a keyboard error; it will stop for all other errors.
All, But Diskette	The system boot will not be halted for a disk error; it will stop for all other errors.
All, But Disk/Key	The system boot will not be halted for a keyboard or disk error; it will stop for all others.

## Advanced BIOS Features

This section allows you to configure and improve your system and allows you to set up some system features according to your preference.

CMOS Setup Utility – Copyright ©1984-2000 Award Software  
Advanced BIOS Features

		ITEM HELP
Virus Warning	Disabled	Menu Level
CPU Internal Cache	Enabled	
External Cache	Enabled	
CPU L2 Cache ECC Checking	Enabled	
Processor Number Feature	Enabled	
Quick Power On Self Test	Enabled	
First Boot Device	Floppy	
Second Boot Device	HDD-0	
Third Boot Device	CDROM	
Boot Other Device	Enabled	
Swap Floppy Drive	Disabled	
Boot Up Numlock Status	On	
Gate A20 Option	Fast	
Typematic Rate Setting	Disabled	
Typematic Rate (chars/Sec)	6	
Typematic Delay (Msec)	250	
Security Option	Setup	
OS Select For DRAM>64MB	Non-OS2	
Report No FDD For WIN 95	No	
Video BIOS Shadow	Enabled	
		Allows you choose the VIRUS warning feature for IDE Hard Disk boot sector protection. If this function is enabled and someone attempt to write data into this area, BIOS will show a warning message on screen and alarm beep

### Virus Warning

This item protects the boot sector and partition table of your hard disk against accidental modifications. If an attempt is made, the BIOS will halt the system and display a warning message. If this occurs, you can either allow the operation to continue or run an anti-virus program to locate and remove the problem.

### CPU Internal Cache / External Cache

Cache memory is additional memory that is much faster than conventional DRAM (system memory). CPUs from 486-type on up contain internal cache memory, and most, but not all, modern PCs have additional (external) cache memory. When the CPU requests data, the system transfers the requested data from the main DRAM into cache memory, for even faster access by the CPU. These items allow you to enable (speed up memory access) or disable the cache function. By default, these items are *Enabled*.

### CPU L2 Cache ECC Checking

This field enables or disables the ECC (Error Correction Checking) checking of the CPU level-2 cache. The default setting is *Enabled*.

### **Processor Number Feature**

When enabled, this feature allows external systems to detect the processor number/type of the CPU.

### **Quick Power On Self Test**

When enabled, this field speeds up the Power On Self Test (POST) after the system is turned on. If it is set to *Enabled*, BIOS will skip some items.

### **First/Second/Third Boot Device**

These fields determine the drive that the system searches first for an operating system. The options available include *Floppy*, *LS/ZIP*, *HDD-0*, *SCSI*, *CDROM*, *HDD-1*, *HDD-2*, *HDD-3*, *LAN* and *Disable*.

### **Boot Other Device**

These fields allow the system to search for an operating system from other devices other than the ones selected in the First/Second/Third Boot Device.

### **Swap Floppy Drive**

This item allows you to determine whether or not to enable Swap Floppy Drive. When enabled, the BIOS swaps floppy drive assignments so that Drive A becomes Drive B, and Drive B becomes Drive A. By default, this field is set to *Disabled*.

### **Boot Up NumLock Status**

This allows you to activate the NumLock function after you power up the system.

### **Gate A20 Option**

This field allows you to select how Gate A20 is worked. Gate A20 is a device used to address memory above 1 MB.

### **Typematic Rate Setting**

When disabled, continually holding down a key on your keyboard will generate only one instance. When enabled, you can set the two typematic controls listed next. By default, this field is set to *Disabled*.

### **Typematic Rate (Chars/Sec)**

When the typematic rate is enabled, the system registers repeated keystrokes speeds. Settings are from 6 to 30 characters per second.

**Typematic Delay (Msec)**

When the typematic rate is enabled, this item allows you to set the time interval for displaying the first and second characters. By default, this item is set to *250msec*.

**Security Option**

This field allows you to limit access to the System and Setup. The default value is *Setup*. When you select *System*, the system prompts for the User Password every time you boot up. When you select *Setup*, the system always boots up and prompts for the Supervisor Password only when the Setup utility is called up.

**OS Select for DRAM > 64MB**

This option allows the system to access greater than 64MB of DRAM memory when used with OS/2 that depends on certain BIOS calls to access memory. The default setting is *Non-OS/2*.

**Video BIOS Shadow**

This item allows you to change the Video BIOS location from ROM to RAM. Video Shadow will increase the video speed.

**C8000 - CBFFF Shadow/DC000 - DFFFF Shadow**

Shadowing a ROM reduces the memory available between 640KB to 1024KB. These fields determine whether or not optional ROM will be copied to RAM.

## Advanced Chipset Features

This Setup menu controls the configuration of the chipset.

CMOS Setup Utility – Copyright ©1984-2000 Award Software  
Advanced Chipset Features

SDRAM CAS Latency Time	3	ITEM HELP
SDRAM Cycle Time Tras/Trc	7/9	Menu Level
SDRAM RAS-to-CAS Delay	3	
SDRAM RAS Precharge Time	3	
System BIOS Cacheable	Disabled	
Video BIOS Cacheable	Disabled	
Memory Hole At 15M-16M	Disabled	
CPU Latency Timer	Enabled	
Delayed Transaction	Enabled	
AGP Graphics Aperture Size	64MB	
System Memory Frequency	100Mhz	
Ower-Supply Type	Auto	
On-Chip Video Window Size	64MB	

### SDRAM CAS Latency Time

You can select CAS latency time in HCLKs of 2/2 or 3/3. The system board designer should set the values in this field, depending on the DRAM installed. Do not change the values in this field unless you change specifications of the installed DRAM or the installed CPU. The choices are 2 and 3.

### SDRAM Cycle Time Tras/Trc

The default setting for the SDRAM Cycle Time Tras/Trc is 7/9.

### SDRAM RAS-to-CAS Delay

You can select RAS to CAS Delay time in HCLKs of 2/2 or 3/3. The system board designer should set the values in this field, depending on the DRAM installed. Do not change the values in this field unless you change specifications of the installed DRAM or the installed CPU. The choices are 2 and 3.

### SDRAM RAS Precharge Time

This option defines the length of time for Row Address Strobe is allowed to precharge. The choices are 2 and 3.

### System BIOS Cacheable

The setting of *Enabled* allows caching of the system BIOS ROM at F000h-FFFFh, resulting in better system performance. However, if any program writes to this memory area, a system error may result.



**Video BIOS Cacheable**

The Setting *Enabled* allows caching of the video BIOS ROM at C0000h-F7FFFh, resulting in better video performance. However, if any program writes to this memory area, a system error may result.

**Memory Hole At 15M-16M**

In order to improve performance, certain space in memory can be reserved for ISA cards. This memory must be mapped into the memory space below 16 MB. The choices are *Enabled* and *Disabled*.

**CPU Latency Timer**

The default setting for the CPU Latency Timer is *Enabled*.

**Delayed Transaction**

The chipset has an embedded 32-bit posted write buffer to support delay transactions cycles. Select *Enabled* to support compliance with PCI specification version 2.1.

**AGP Aperture Size**

The field sets aperture size of the graphics. The aperture is a portion of the PCI memory address range dedicated for graphics memory address space. Host cycles that hit the aperture range are forwarded to the AGP without any translation. The default setting is *64M*.

**System Memory Frequency**

This field sets the frequency of the memory installed in the CPU card. The default setting is *100MHz*.

**Power-Supply Type**

This field sets the power supply type being used by the system. The default setting is *Auto*.

**On-Chip Video Window Size**

The setting choices for the On-Chip Video Window Size are *64MB* and *32MB*. By default, this option is set to *64MB*.

## Integrated Peripherals

This section sets configurations for your hard disk and other integrated peripherals.

CMOS Setup Utility – Copyright ©1984-2000 Award Software

### Integrated Peripherals

			ITEM HELP
On-Chip Primary PCI IDE	Enabled		Menu Level
On-Chip Secondary PCI IDE	Enabled		
IDE Primary Master PIO	Auto		
IDE Primary Slave PIO	Auto		
IDE Secondary Master PIO	Auto		
IDE Secondary Slave PIO	Auto		
IDE Primary Master UDMA	Auto		
IDE Primary Slave UDMA	Auto		
IDE Secondary Master UDMA	Auto		
IDE Secondary Slave UDMA	Auto		
USB Controller	Enabled		
USB Keyboard Support	Disabled		
Init Display First	PCI Slot		
AC97 Audio	Auto		
IDE Block Mode	Disabled		
Onboard FDC Controller	Enabled		
Onboard Serial Port 1	3F8/IRQ4		
Onboard Serial Port 2	2F8/IRQ3		
UART Mode Select	Normal		
UR2 Duplex Mode	Half		
Onboard Parallel Port	378/IRQ7		
Parallel Port Mode	SPP		
ECP Mode Use DMA	3		
Power After PWR Fail	Off		
Midi Port Address	330		
Midi Port IRQ	10		

### OnChip Primary/Secondary PCI IDE

The integrated peripheral controller contains an IDE interface with support for two IDE channels. Select *Enabled* to activate each channel separately.

### IDE Primary/Secondary Master/Slave PIO

These fields allow your system hard disk controller to work faster. Rather than have the BIOS issue a series of commands that transfer to or from the disk drive, PIO (Programmed Input/Output) allows the BIOS to communicate with the controller and CPU directly.

The system supports five modes, numbered from 0 (default) to 4, which primarily differ in timing. When Auto is selected, the BIOS will select the best available mode.

**IDE Primary/Secondary Master/Slave UDMA**

These fields allow your system to improve disk I/O throughput to 33Mb/sec with the Ultra DMA/33 feature. The options are *Auto* and *Disabled*.

**USB Controller**

The options for this field are *Enabled* and *Disabled*. By default, this field is set to *Enabled*.

**USB Keyboard Support**

The options for this field are *Enabled* and *Disabled*. By default, this field is set to *Disabled*.

**Init Display First**

This field allows the system to initialize first the VGA card on chip or the display on the PCI Slot. By default, the *PCI Slot* VGA is initialized first.

**AC97 Audio**

The default setting of the AC97 Audio is *Auto*.

**IDE HDD Block Mode**

This field allows your hard disk controller to use the fast block mode to transfer data to and from your hard disk drive.

**Onboard FDC Controller**

Select *Enabled* if your system has a floppy disk controller (FDC) installed on the CPU card and you wish to use it. If you install an add-in FDC or the system has no floppy drive, select *Disabled* in this field. This option allows you to select the onboard FDD port.

### Onboard Serial/Parallel Port

These fields allow you to select the onboard serial and parallel ports and their addresses. The default values for these ports are:

Serial Port 1	3F8/IRQ4
Serial Port 2	2F8/IRQ3
Parallel Port	378H/IRQ7

### UART Mode Select

This field determines the UART 2 mode in your computer. The default value is *Normal*. Other options include *IrDA* and *ASKIR*.

### Parallel Port Mode

This field allows you to determine parallel port mode function.

SPP	Standard Printer Port
EPP	Enhanced Parallel Port
ECP	Extended Capabilities Port

### Power After PWR Fail

This option sets the power state of the system after power fails for some reason whether the system powers up when power resumes or remains in an off state. The default setting is *Off*.

### Midi Port Address

The option settings for this field are *330*, *400* and *Disabled*. The default setting is *330*.

### Midi Port IRQ

The default Midi Port IRQ is *10*.

## Power Management Setup

The Power Management Setup allows you to save energy of your system effectively.

CMOS Setup Utility – Copyright ©1984-2000 Award Software  
Power Management Setup

ACPI Function	Disable	ITEM HELP
Power Management	User Define	Menu Level
Video Off Method	V/H Sync+Blank	
Video Off In Suspend	No	
Suspend Type	Stop Grant	
Modem Use IRQ	NA	
Suspend Mode	Disabled	
HDD Power Down	Disabled	
Soft-Off by PWR-BTTN	Instant-Off	
Wake-Up by PCI Card	Disabled	
Power On by Ring	Disabled	
Resume by Alarm	Disabled	
Date (of Month) Alarm	0	
Time (hh:mm:ss) Alarm	0	
** Reload Global Timer Events **		
Primary IDE 0	Enabled	
Primary IDE 1	Enabled	
Secondary IDE 0	Enabled	
Secondary IDE 1	Enabled	
FDD, COM, LPT Port	Enabled	
PCI PIRQ[A-D] #	Enabled	

### ACPI Function

Enable this function to support ACPI (Advance Configuration and Power Interface).

### Power Management

This field allows you to select the type of power saving management modes. There are four selections for Power Management.

Min. Power Saving	Minimum power management
Max. Power Saving	Maximum power management.
User Define	Each of the ranges is from 1 min. to 1hr. Except for HDD Power Down which ranges from 1 min. to 15 min.

### Video Off Method

This field defines the Video Off features. There are three options.

V/H SYNC + Blank	Default setting, blank the screen and turn off vertical and horizontal scanning.
DPMS	Allows BIOS to control the video display.
Blank Screen	Writes blanks to the video buffer.

### **Video Off In Suspend**

When enabled, the video is off in suspend mode. The default setting is *Yes*.

### **Suspend Type**

The default setting for the Suspend Type field is *Stop Grant*.

### **Modem Use IRQ**

This field sets the IRQ used by the Modem. By default, the setting is *3*.

### **Suspend Mode**

When enabled, and after the set time of system inactivity, all devices except the CPU will be shut off.

### **HDD Power Down**

When enabled, and after the set time of system inactivity, the hard disk drive will be powered down while all other devices remain active.

### **Soft-Off by PWRBTN**

This field defines the power-off mode when using an ATX power supply. The *Instant Off* mode allows powering off immediately upon pressing the power button. In the *Delay 4 Sec* mode, the system powers off when the power button is pressed for more than four seconds or enters the suspend mode when pressed for less than 4 seconds.

### **Wake-Up by PCI Cards**

Enable this field to allow wake up function through a PCI card.

### **Power On by Ring**

This field enables or disables the power on of the system through the modem connected to the serial port or LAN.

### **Resume by Alarm**

This field enables or disables the resumption of the system operation. When enabled, the user is allowed to set the *Date* and *Time*.

### **Reload Global Timer Events**

The HDD, FDD, COM, LPT Ports, and PCI PIRQ are I/O events which can prevent the system from entering a power saving mode or can awaken the system from such a mode. When an I/O device wants to gain the attention of the operating system, it signals this by causing an IRQ to occur. When the operating system is ready to respond to the request, it interrupts itself and performs the service.

## PNP/PCI Configurations

This option configures the PCI bus system. All PCI bus systems on the system use INT#, thus all installed PCI cards must be set to this value.

CMOS Setup Utility – Copyright ©1984-2000 Award Software  
PnP/PCI Configurations

PNP OS Install	No	<p>ITEM HELP</p> <p>Menu Level</p> <p>Default is Disabled. Select Enabled to reset Extended System Configuration Data (ESCD) when you exit Setup if you have installed a new add-on and the system reconfiguration has caused such a serious conflict that the OS cannot boot</p>
Reset Configuration Data	Disabled	
Resources Controlled By IRQ Resources	Auto (ESCD) Press Enter	
PCI/VGA Palette Snoop	Disabled	

### PNP OS Install

Enable the PNP OS Install option if it is supported by the operating system installed. The default value is *No*.

### Reset Configuration Data

This field allows you to determine whether to reset the configuration data or not. The default value is *Disabled*.

### Resources Controlled by

This PnP BIOS can configure all of the boot and compatible devices automatically with the use of a use a PnP operating system such as Windows 95.

### PCI/VGA Palette Snoop

Some non-standard VGA display cards may not show colors properly. This field allows you to set whether or not MPEG ISA/VESA VGA cards can work with PCI/VGA. When this field is enabled, a PCI/VGA can work with an MPEG ISA/VESA VGA card. When this field is disabled, a PCI/VGA cannot work with an MPEG ISA/VESA card.

### PC Health Status

This section shows the parameters in determining the PC Health Status. These parameters include temperatures, fan speeds and voltages.

CMOS Setup Utility – Copyright ©1984-2000 Award Software  
PC Health Status

		ITEM HELP
Shutdown Temperature	Disabled	
Vcore (V)	1.63V	
+1.8(V)	1.79V	
VCC3(V)	3.37V	
+5(V)	5.05V	
+12(V)	12.09V	
-12(V)	(-)12.03V	
5VSB(V)	5.05V	
Voltage Battery	3.24V	
System Temp.	41°C	
CPU Temp.	59°C	
System Temp.	42°C	
CPU Fan Speed	4166 RPM	
System Fan Speed	0 RPM	
System Fan Speed	0 RPM	

### Shutdown Temperature

This field allows the user to set the temperature by which the system automatically shuts down once the threshold temperature is reached. This function can help prevent damage to the system that is caused by overheating.

### Temperatures/Fan Speeds/Voltages

These fields are the parameters of the hardware monitoring function feature of the CPU card. The values are read-only values as monitored by the system and show the PC health status.



## Frequency/Voltage Control

This section shows the user how to configure the processor frequency.

CMOS Setup Utility – Copyright ©1984-2000 Award Software  
Frequency/Voltage Control

Auto Detect DIMM/PCI Clk	Disabled	ITEM HELP
Spread Spectrum	Disabled	Menu Level
Host CPU/PCI Clock	Default	
CPU Clock Ratio	X 3	

### Auto Detect DIMM/PCI Clk

This field enables or disables the auto detection of the DIMM/PCI clock. The default setting is *Disabled*.

### Spread Spectrum

This field sets the value of the spread spectrum. The default setting is *Disabled*. This field is for CE testing use only.

### Host CPU/PCI Clock

The Host CPU/PCI Clock has a default setting of *Default* which automatically detects the systems host CPU clock and PCI clock. You can also use this parameter to overclock your system. However, it is important to note that overclocking the system/CPU can cause your system to become unstable or crash.

### CPU Clock Ratio

The CPU Ratio, also known as the CPU bus speed multiplier, can be configured through this field. The default setting is *X 3*. This parameter can be used in conjunction with the above field to change the processor's speed.

### **Load Fail-Safe Defaults**

This option allows you to load the troubleshooting default values permanently stored in the BIOS ROM. These default settings are non-optimal and disable all high-performance features.

### **Load Setup Defaults**

This option allows you to load the default values to your system configuration. These default settings are optimal and enable all high performance features.

### **Set Supervisor/User Password**

These two options set the system password. Supervisor Password sets a password that will be used to protect the system and Setup utility. User Password sets a password that will be used exclusively on the system. To specify a password, highlight the type you want and press <Enter>. The Enter Password: message prompts on the screen. Type the password, up to eight characters in length, and press <Enter>. The system confirms your password by asking you to type it again. After setting a password, the screen automatically returns to the main screen.

To disable a password, just press the <Enter> key when you are prompted to enter the password. A message will confirm the password to be disabled. Once the password is disabled, the system will boot and you can enter Setup freely.

### **Save & Exit Setup**

This option allows you to determine whether or not to accept the modifications. If you type “Y”, you will quit the setup utility and save all changes into the CMOS memory. If you type “N”, you will return to Setup utility.

### **Exit Without Saving**

Select this option to exit the Setup utility without saving the changes you have made in this session. Typing “Y” will quit the Setup utility without saving the modifications. Typing “N” will return you to Setup utility.

---

## Drivers Installation

This section describes the installation procedures for software and drivers under the Windows 98, Windows NT 4.0 and Windows 2000. The software and drivers are included with the CPU card. If you find the items missing, please contact the vendor where you made the purchase. The contents of this section include the following:

Windows 98 Drivers Installation .....	48
Intel Software Installation Utility.....	48
Intel Ultra ATA Storage Driver .....	51
Intel 815E(B) Chipset VGA Driver .....	54
SigmaTel AC97 Audio Drivers .....	57
PCI Ethernet Drivers.....	60
Windows NT 4.0 Drivers Installation .....	61
Intel Ultra ATA Storage Driver .....	61
Intel 815E(B) Chipset VGA Driver .....	64
SigmaTel AC97 Audio Drivers .....	67
PCI Ethernet Drivers.....	70
Windows 2000 Drivers Installation .....	70
Intel 815E(B) Chipset VGA Driver .....	70
SigmaTel AC97 Audio Drivers .....	71
PCI Ethernet Drivers.....	73

## Windows 98 Drivers Installation

---

### Intel Software Installation Utility

The Intel Chipset Software Installation Utility will enable Plug & Play INF support for Intel chipset components. Follow the instructions below to complete the installation under Windows 98.

1. Insert the CD that comes with the CPU card and the screen below would appear. Click Intel 815(E) Driver.



2. Click Intel Chipset Software Installation Utility.

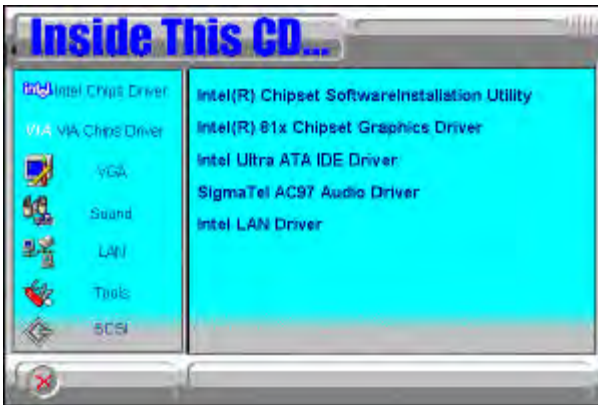

3. When the Welcome screen appears, click Next to continue.

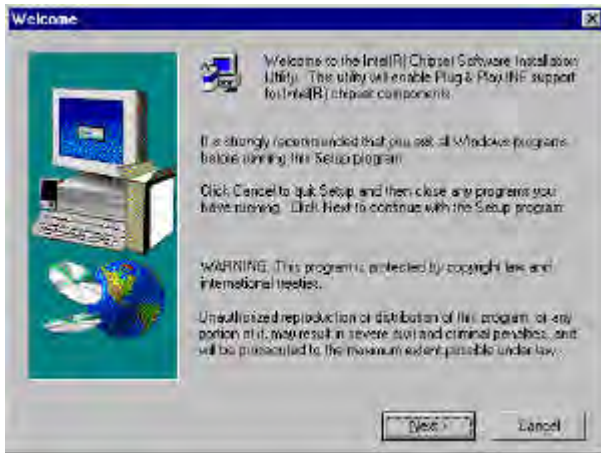

4. Click Yes to accept the software license agreement and proceed with the installation process.

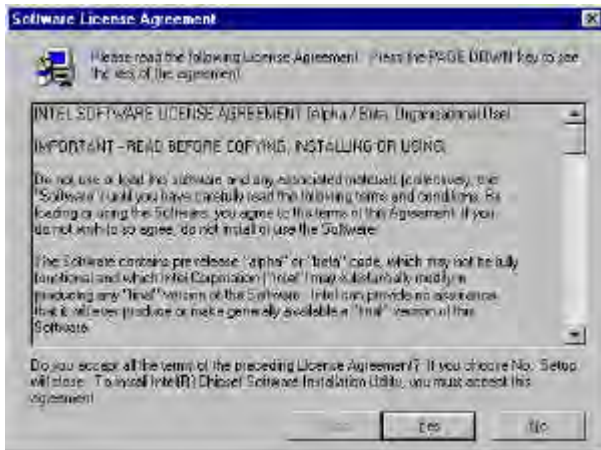

5. On Readme Information screen, click Next to continue the installation.

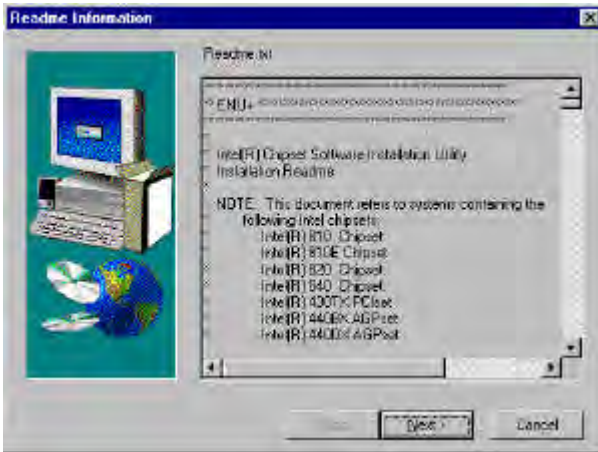

6. The Setup process is now complete. Click Finish to restart the computer and for changes to take effect. When the computer has restarted, the system will be able to find some devices. Restart your computer when prompted.

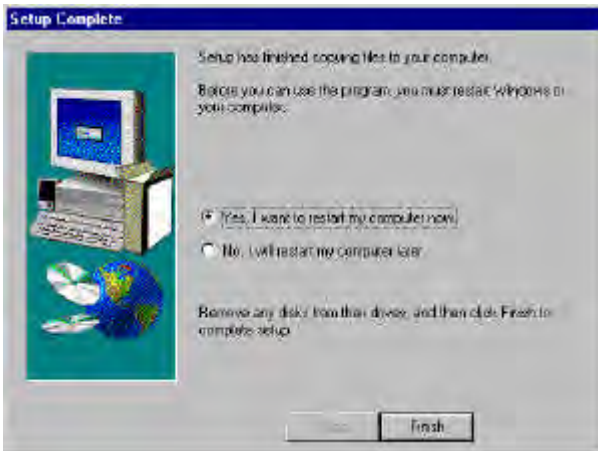

## Intel Ultra ATA Storage Driver

Follow the steps below to install Intel Ultra ATA Storage Driver with the InstallShield Wizard under Windows 98.

1. Insert the CD that comes with the CPU card and the screen below would appear. Click Intel 815(E) Driver.

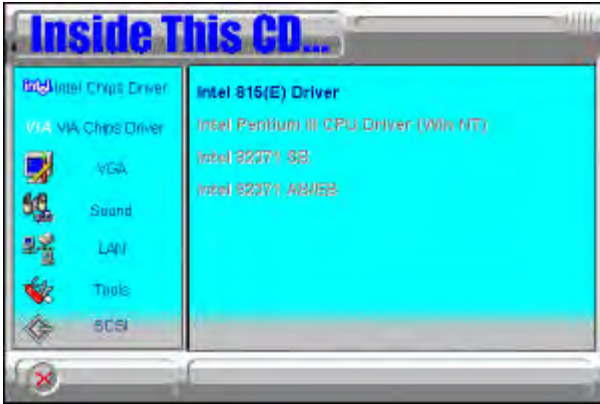

2. Click Intel Ultra ATA IDE Driver.



3. The Welcome screen of the Install Shield Wizard for Intel Ultra ATA Storage Driver appears. To continue, click Next.



4. Click Yes to accept the software license agreement and proceed with the installation process.





5. You are now required to Select the folder where Setup will install files. Click Next to accept the default folder or click Browse to configure the location.

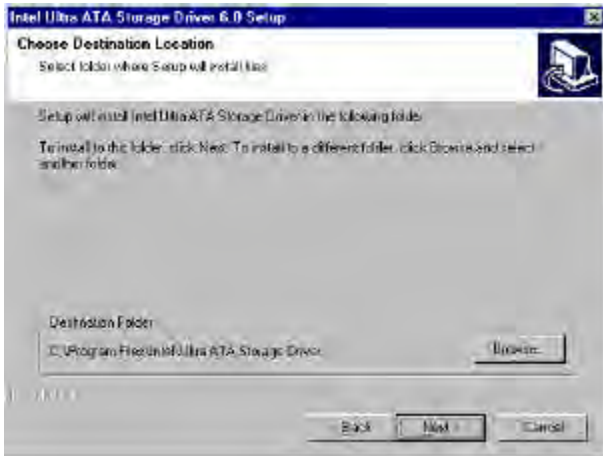

6. You are now asked to select a program folder. Click Next to accept the default program folder or enter the folder name you prefer.

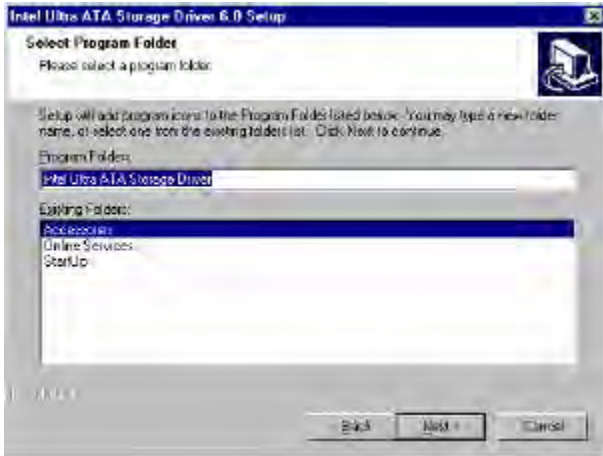

7. The InstallShield Wizard has completed installation. Click Finish for the computer to restart and changes to take effect.



### Intel 815(E) Chipset VGA Driver

Follow the steps below to install Intel 81x Family Chipset Graphics Driver Software under Windows 98.

1. Insert the CD that comes with the CPU card and the screen below would appear. Click Intel 815(E) Driver.



2. Click Intel 81x Chipset Graphics Driver.

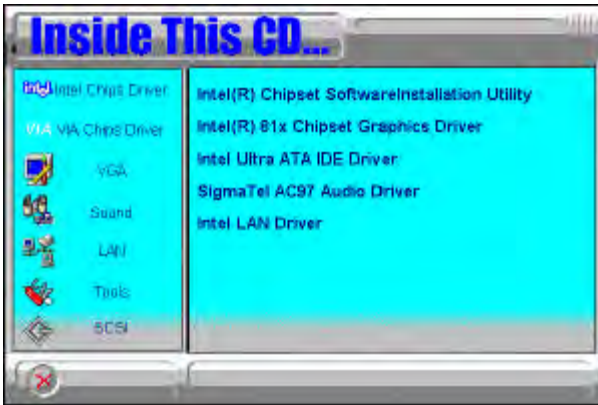

3. The Welcome screen of the Intel 81x Family Chipset Graphics Driver Software Setup program appears. To continue, click Next.

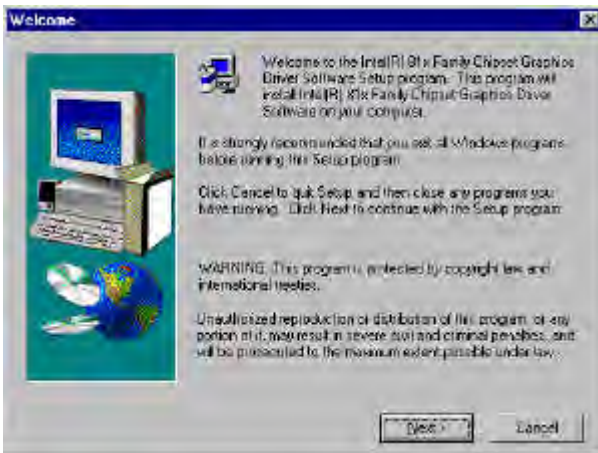

4. Click Yes to accept the software license agreement and proceed with the installation process.

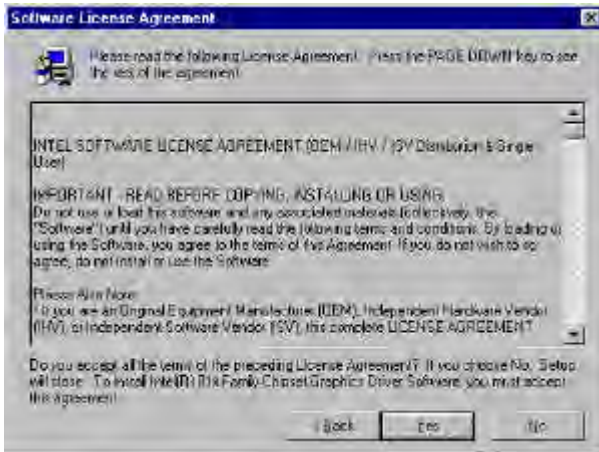

5. The Setup program has now completed installation. Click Finish for the computer to restart and changes to take effect.

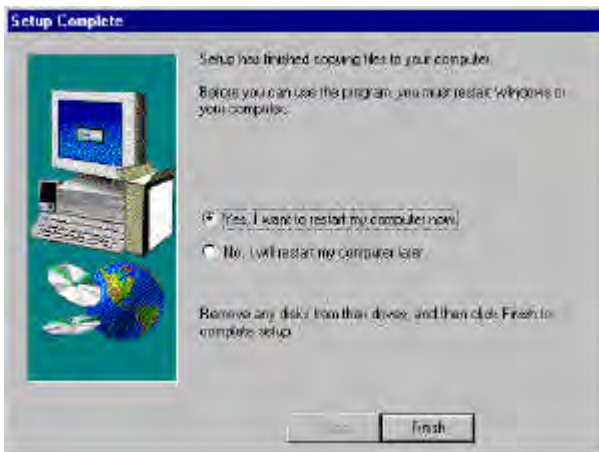

## SigmaTel AC97 Audio Drivers

Follow the steps below to install SigmaTel AC97 Audio Drivers on your system under Windows 98.

1. Insert the CD that comes with the CPU card and the screen below would appear. Click Intel 815(E) Driver.

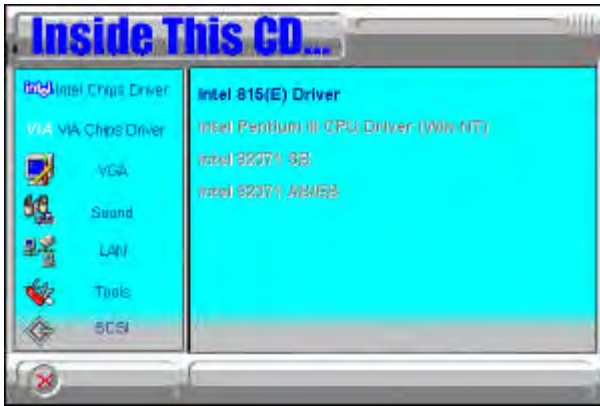

2. Click SigmaTel AC97 Audio Driver.



3. The Welcome screen of the SigmaTel AC97 Audio Driver Setup program appears. To continue, click Next.

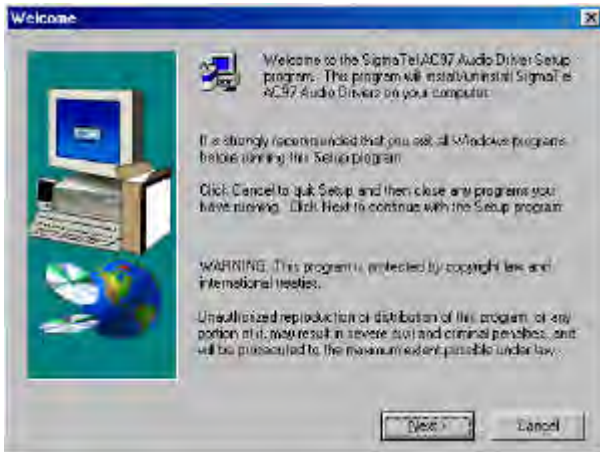

4. Click Yes to accept the software license agreement and proceed with the installation process.

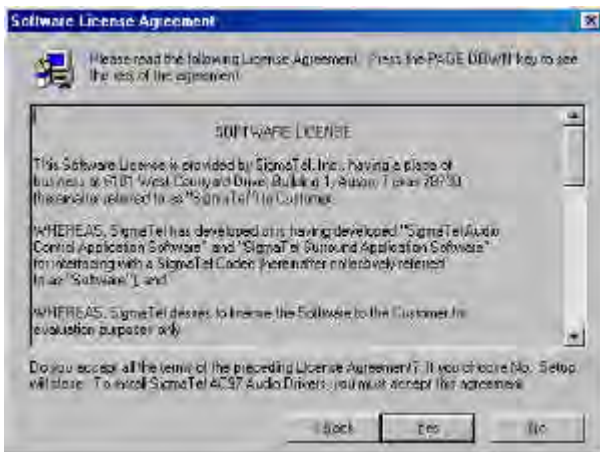

5. Select Install and click Next to install SigmaTel AC97 Audio Drivers on your system.

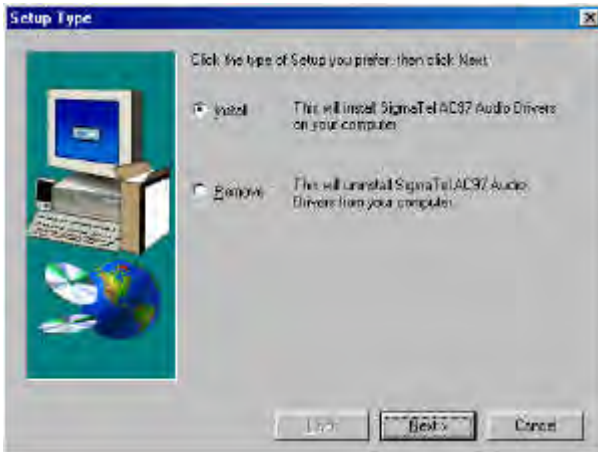

6. The Setup program has now completed installation. Click Finish for the computer to restart and changes to take effect.

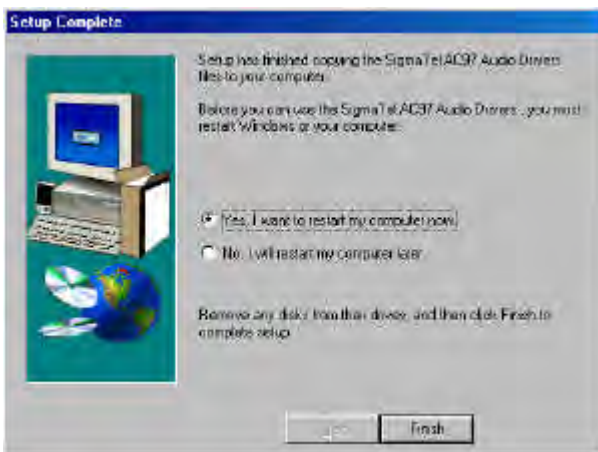

7. After the system has restarted, a screen would appear saying it was able to find the device “Intel AC’ 97 Audio Controller.” Click Next to continue.

8. Now click Select to “Search for the best river for your device (Recommended).” Click Next, then click Select to “specify a location”. Now enter the path as “d:\intel\i815E(B)\sound\win98\driver\wdm” (This is assuming drive D: is your CD-ROM drive.

9. Now click Next and Next again. You are now prompted to place the Windows 98 CD into the CD-ROM drive. Do so accordingly and click OK. Then click Finish to restart the system and for changes to take effect.

### **PCI Ethernet Drivers**

Follow the steps below to install the PCI Ethernet/LAN drivers Windows 98.

1. Under the Windows 98 environment, click Start → Control Panel. Double click System → Device Manager.
2. Click Other Devices → PCI Ethernet Controller.
3. Click Driver → Update Driver → Next.
4. Now select “Display a list of all the drivers in a specific location.”
5. Click Next and select “Network adapters.”
6. Click Next → Have Disk....
7. Now insert the floppy diskette containing the Ethernet drivers for Windows 98 and click OK → OK → Next.
8. You are now prompted to insert the Windows 98 CD-ROM into the CD-ROM drive. Do so accordingly and click OK.
9. When file copying is done, click Yes to restart the system and changes to take effect.



---

## Windows NT 4.0 Drivers Installation

---

### Intel Ultra ATA Storage Driver

Follow the steps below to install Intel Ultra ATA Storage Driver with the InstallShield Wizard under Windows NT 4.0.

1. Insert the CD that comes with the CPU card and the screen below would appear. Click Intel 815(E) Driver.

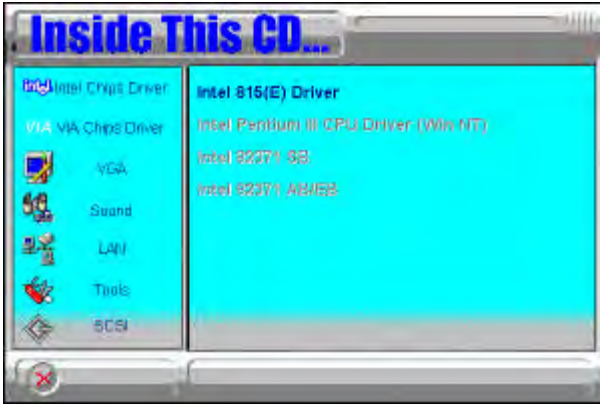

2. Click Intel Ultra ATA IDE Driver.

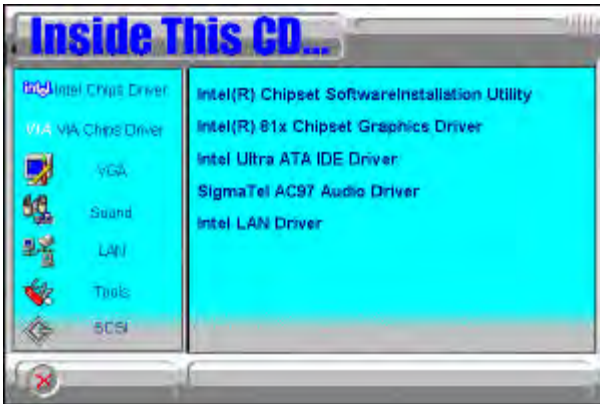

3. The Welcome screen of the Install Shield Wizard for Intel Ultra ATA Storage Driver appears. To continue, click Next.



4. Click Yes to accept the software license agreement and proceed with the installation process.



5. You are now required to Select the folder where Setup will install files. Click Next to accept the default folder or click Browse to configure the location.

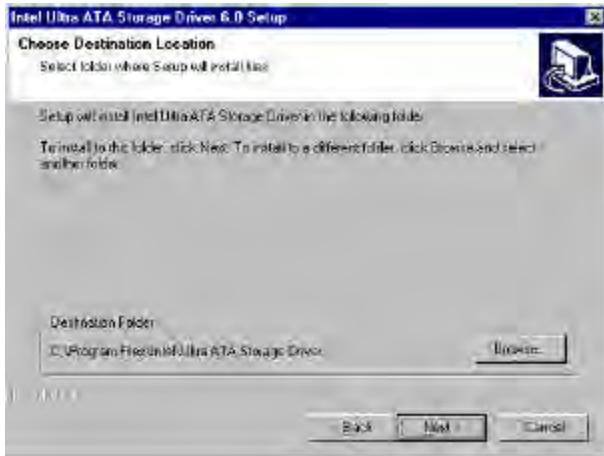

6. You are now asked to select a program folder. Click Next to accept the default program folder or enter the folder name you prefer.

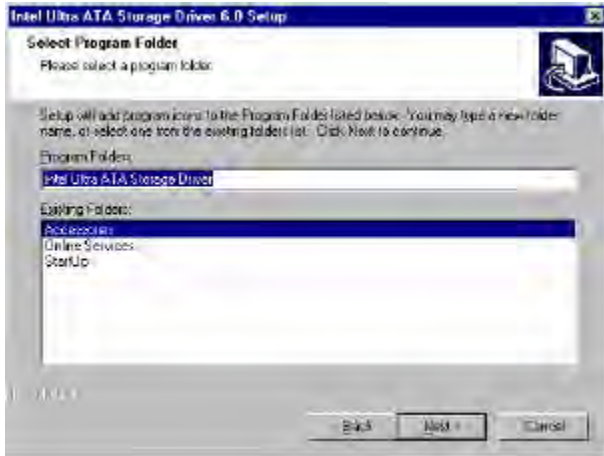

7. The InstallShield Wizard has completed installation. Click Finish for the computer to restart and changes to take effect.



### Intel 815(B) Chipset VGA Driver

Follow the steps below to install Intel 81x Family Chipset Graphics Driver Software under Windows NT 4.0.

1. Insert the CD that comes with the CPU card and the screen below would appear. Click Intel 815(E) Driver.

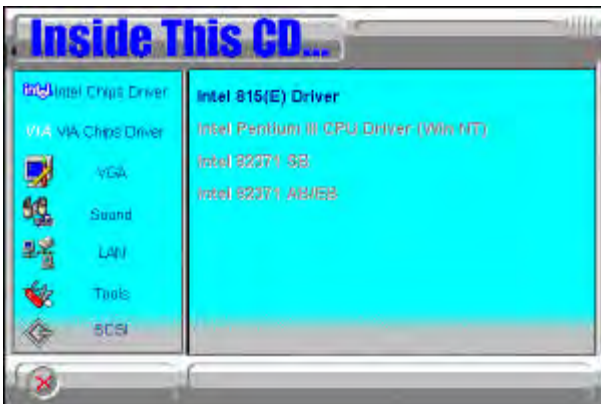

2. Click Intel 81x Chipset Graphics Driver.



3. The Welcome screen of the Intel 81x Family Chipset Graphics Driver Software Setup program appears. To continue, click Next.

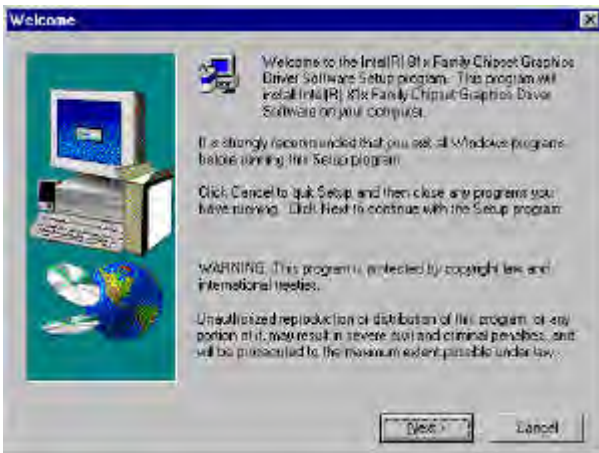

4. Click Yes to accept the software license agreement and proceed with the installation process.

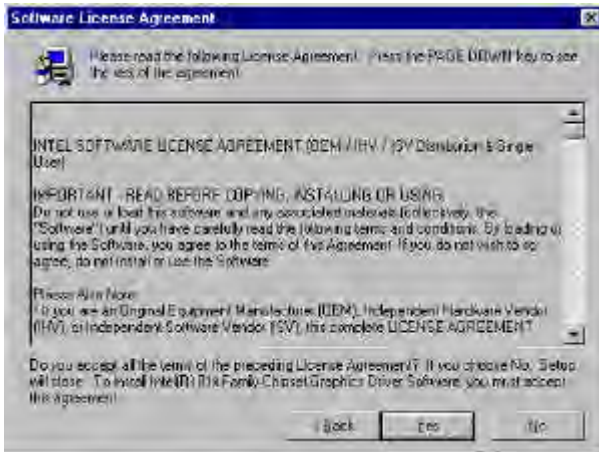

5. The Setup program has now completed installation. Click Finish for the computer to restart and changes to take effect.

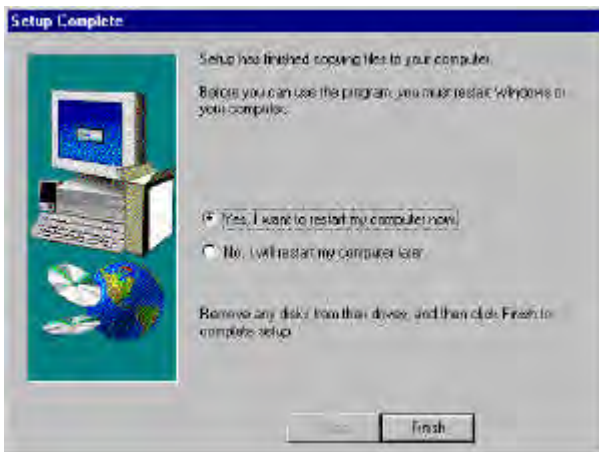

## SigmaTel AC97 Audio Drivers

Follow the steps below to install SigmaTel AC97 Audio Drivers on your system under Windows NT 4.0.

1. Insert the CD that comes with the CPU card and the screen below would appear. Click Intel 815(E) Driver.

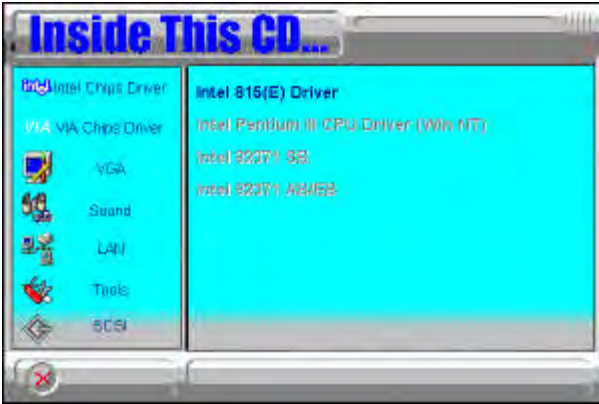

2. Click SigmaTel AC97 Audio Driver.



3. The Welcome screen of the SigmaTel AC97 Audio Driver Setup program appears. To continue, click Next.

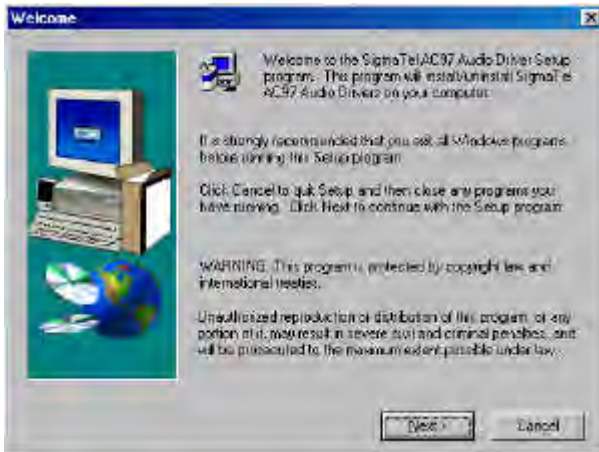

4. Click Yes to accept the software license agreement and proceed with the installation process.

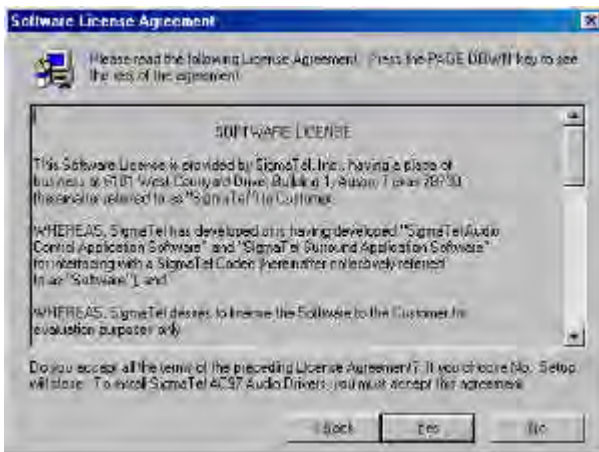



5. Select Install and click Next to install SigmaTel AC97 Audio Drivers on your system.

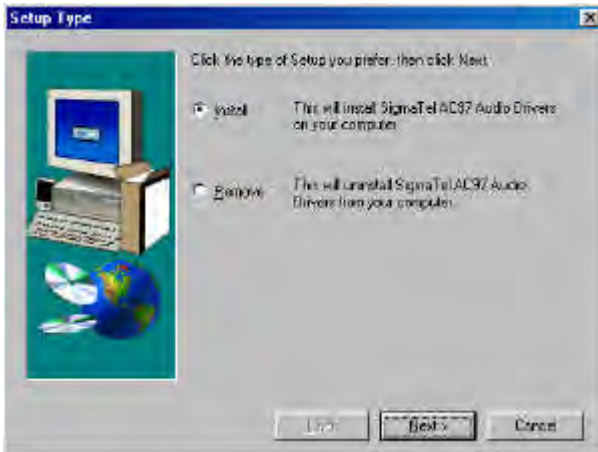

6. The Setup program has now completed installation. Click Finish for the computer to restart and changes to take effect.

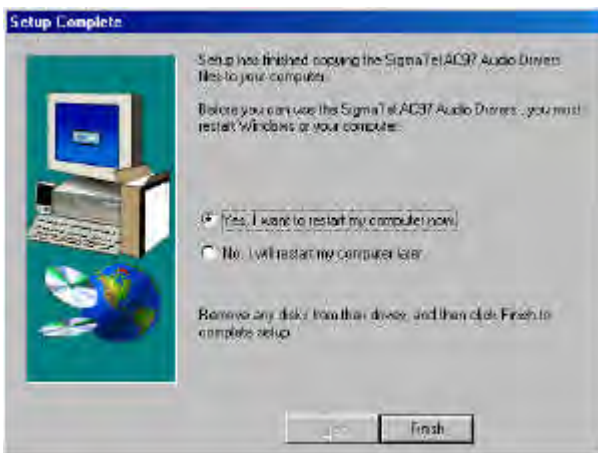

7. After the system has restarted, a screen would appear showing some installation information. Restart the system when prompted to complete the audio driver installation.

### **PCI Ethernet Drivers**

Follow the steps below to install the PCI Ethernet/LAN drivers Windows NT 4.0.

1. Under the Windows NT 4.0 environment, click Start → Control Panel. Double click Network → Adapters → Add.
2. Select “Have disk ...” and insert the floppy diskette containing the Ethernet drivers for Windows NT 4.0 into the FDD drive, then click OK.
3. Click OK → Close, and then enter IP address.
4. Restart the system for changes to take effect.

## **Windows 2000 Drivers Installation**

---

---

### **Intel 815E(B) Chipset VGA Driver**

Follow the steps below to install Intel 81x Family Chipset Graphics Driver Software under Windows 2000.

1. Under the Windows 2000 environment, click Start → Control Panel. Double click System → Hardware → Device Manager → Other Devices.
2. Double-click Video Controller(VGA compatible).
3. Click Driver → Update Driver → Next.
4. Now select “Display a list of the known drivers for this device so that I can choose a specific driver.”
5. Now enter the driver path as “d:\intel\815E(B)\agp\win2000” assuming drive D: is your CD-ROM drive. Click OK and select “Intel 82815 graphics controller.”
6. Click Next → Yes → Next → Finish.
7. Close all tasks and restart the computer.

## SigmaTel AC97 Audio Drivers

Follow the steps below to install SigmaTel AC97 Audio Drivers on your system under Windows 2000.

1. Insert the CD that comes with the CPU card. The CD will autorun and show an initial screen. Click Intel 815(E) Driver.
2. Click SigmaTel AC97 Audio Driver.
3. The Welcome screen of the SigmaTel AC97 Audio Driver Setup program appears. To continue, click Next.

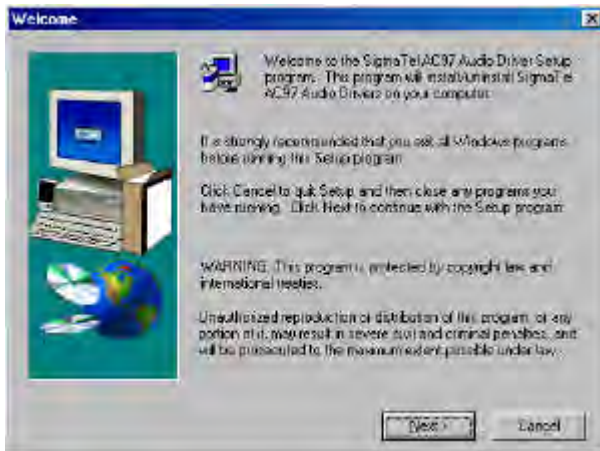

4. Click Yes to accept the software license agreement and proceed with the installation process.

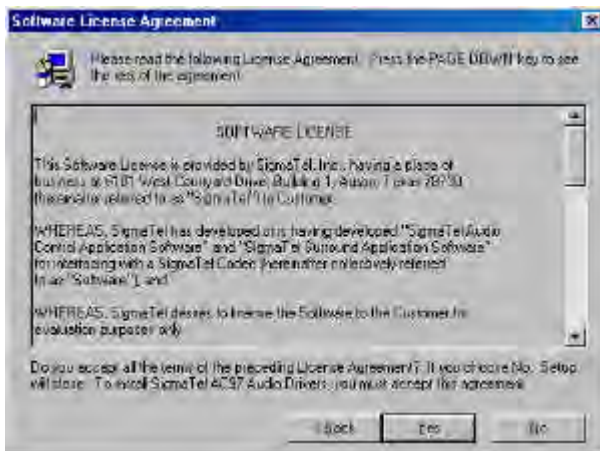

5. Select Install and click Next to install SigmaTel AC97 Audio Drivers on your system.

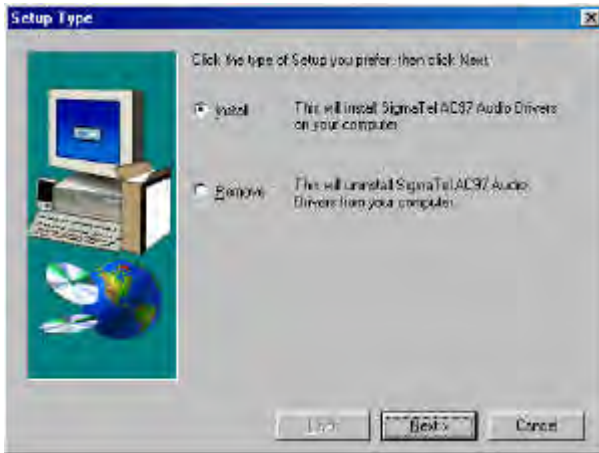

6. A window appears indicating that the software to be installed does not contain a Microsoft digital signature. Click Yes to continue the installation process.

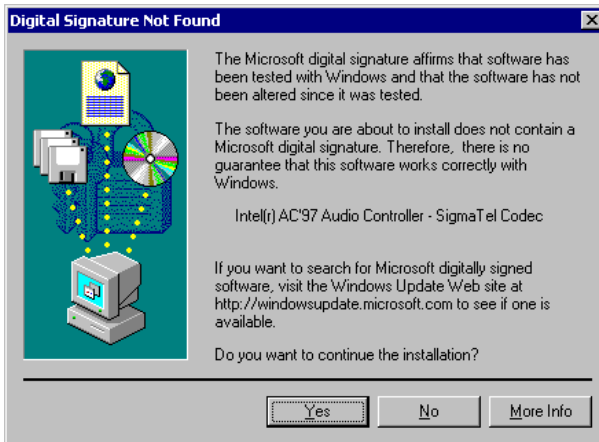

7. The Setup program has now completed installation. Click Finish for the computer to restart and changes to take effect.

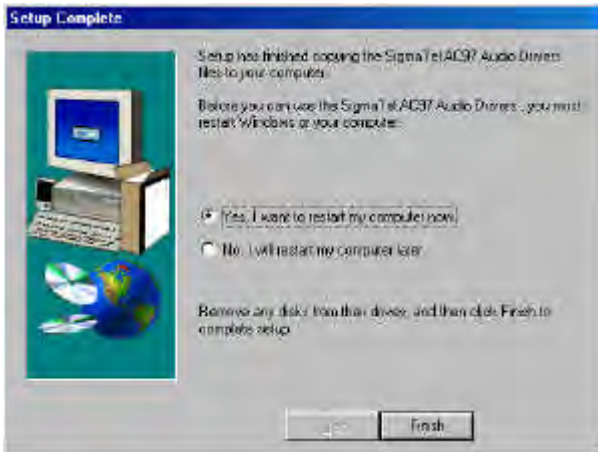

### PCI Ethernet Drivers

Follow the steps below to install the PCI Ethernet/LAN drivers Windows 2000.

1. Under the Windows 2000 environment, click Start → Control Panel. Double click System → Hardware → Device Manager → Other Devices.
2. Double-click Ethernet Controller.
3. Click Driver → Update Driver → Next.
4. Now select “Display a list of the known drivers for this device so that I can choose a specific driver.”
5. Insert the floppy diskette containing the Intel Ethernet drivers into the FDD drive. Click OK and select “Intel PRO/100 VE Network connection.”
6. Click Next → Next → Finish. Close all tasks and restart the computer.

This page was intentionally left blank.

## Appendix

### A. I/O Port Address Map

### B. Interrupt Request Lines (IRQ)

#### A. I/O Port Address Map

Each peripheral device in the system is assigned a set of I/O port addresses which also becomes the identity of the device. The following table lists the I/O port addresses used.

Address	Device Description
000h - 01Fh	DMA Controller #1
020h - 03Fh	Interrupt Controller #1
040h - 05Fh	Timer
060h - 06Fh	Keyboard Controller
070h - 07Fh	Real Time Clock, NMI
080h - 09Fh	DMA Page Register
0A0h - 0BFh	Interrupt Controller #2
0C0h - 0DFh	DMA Controller #2
0F0h	Clear Math Coprocessor Busy Signal
0F1h	Reset Math Coprocessor
1F0h - 1F7h	IDE Interface
278 - 27F	Parallel Port #2(LPT2)
2F8h - 2FFh	Serial Port #2(COM2)
2B0 - 2DF	Graphics adapter Controller
378h - 3FFh	Parallel Port #1(LPT1)
360 - 36F	Network Ports
3B0 - 3BF	Monochrome & Printer adapter
3C0 - 3CF	EGA adapter
3D0 - 3DF	CGA adapter
3F0h - 3F7h	Floppy Disk Controller
3F8h - 3FFh	Serial Port #1(COM1)

## B. Interrupt Request Lines (IRQ)

Peripheral devices use interrupt request lines to notify CPU for the service required. The following table shows the IRQ used by the devices on board.

Level	Function
IRQ0	System Timer Output
IRQ1	Keyboard
IRQ2	Interrupt Cascade
IRQ3	Serial Port #2
IRQ4	Serial Port #1
IRQ5	Reserved
IRQ6	Floppy Disk Controller
IRQ7	Parallel Port #1
IRQ8	Real Time Clock
IRQ9	Reserved
IRQ10	Reserved
IRQ11	Reserved
IRQ12	PS/2 Mouse
IRQ13	80287
IRQ14	Primary IDE
IRQ15	Secondary IDE