

MB894

Socket 479 Pentium® M
Intel® 855GME Micro ATX Motherboard

USER'S MANUAL

Version 1.0

Acknowledgments

Award is a registered trademark of Award Software International, Inc.

PS/2 is a trademark of International Business Machines Corporation.

Intel and Pentium are registered trademarks of Intel Corporation.

Microsoft Windows is a registered trademark of Microsoft Corporation.

Winbond is a registered trademark of Winbond Electronics Corporation.

All other product names or trademarks are properties of their respective owners.

Table of Contents

Introduction	1
Product Description	1
Checklist	2
MB894 Specifications.....	3
Board Dimensions.....	4
Installations	5
Installing the CPU	6
Installing the Memory	7
Setting the Jumpers.....	8
Connectors on MB894	13
Watchdog Timer Configuration.....	25
BIOS Setup	29
Drivers Installation	53
Intel Chipset Software Intallation Utility	54
VGA Drivers Installation	55
AC97 Codec Audio Driver Installation.....	56
Intel PRO LAN Drivers Installation	57
Realtek Network Interface Controller Drivers Installation	58
Appendix.....	59
A. I/O Port Address Map.....	59
B. Interrupt Request Lines (IRQ)	60

This page is intentionally left blank.

Introduction

Product Description

The MB894 Pentium® M Micro ATX motherboard incorporates the Intel® advanced 855GME Chipset that supports processors from 600MHz to 2.0MHz in 479-ball Micro-FCBGA package with a front size bus of 400MHz.

Graphics display functionality is provided by the integrated-chipset VGA controller that supports CRT display and LVDS interface with 24-bit panel specifications. Ethernet connectivity comes from the ICH4-integrated Ethernet 10/100 Ethernet controller and an optional secondary LAN using a Realtek 8110S-32 Gigabit Ethernet.

Two DDR DIMM sockets supports up to 2GB of memory. Four COM ports are supported, with the Winbond W83627HF and Fintek F81216 multi I/O chipsets. There are two IDE connectors – IDE1 supporting UDMA33/66/100 and IDE2 a CF Type II socket for its slave channel.

Other I/O features include watchdog timer, 4-in/4-out digital I/O, and two USB ports on board and four USB ports using pin headers. Expansion slots composed of three PCI, one ISA and one mini PCI slot. The board uses a 20-pin ATX power.

Checklist

Your MB894 package should include the items listed below.

- The MB894 Pentium M ATX Motherboard
- This User's Manual
- 1 CD containing chipset drivers and flash memory utility
- I/O Shield Plate
- IB3A Cable Kit with cables including:
 - 1 FDD Ribbon Cable
 - 1 IDE Ribbon Cable
 - 1 COM Port Cable
 - 1 COM Port Cable (with two connectors)
- Optional cables such as:
 - USB Cable with two connectors (USB2K-4)

MB894 Specifications

Form Factor	Micro ATX
CPU Type	Micro-FCPGA Intel Pentium M / Celeron M CPU
CPU Voltage	0.700V ~ 1.708V
System Speed	Up to 2GHz
FSB	400 MHz processor operating frequency
Green /APM	APM1.2
CPU Socket	Socket 479
Chipset	Intel 855GME / 852GM Chipset: GMCH: 82855GME 732-pin mFCBGA / 82852GM ICH4: 82801DB 421-pin BGA
BIOS	Award BIOS; Support ACPI function
Cache	1MB Level 2 (CPU integrated)
VGA	Intel 82855GME / 82852GM built-in Intel extreme Graphics 2; Intel Dynamic Video Memory up to 64MB shared with system
LVDS	Intel 82855GME built-in, support resolution up to 1600x1200, 24bit dual channel.
Memory type	Two DDR DIMM socket, support up to 2GB DDR 200/266/333 SDRAM
1st LAN	ICH4 integrated LAN (10/100Mb) + PHY 82562ET
2nd LAN	RTL8110s-32 (10/100/1000) Ethernet Controller.
USB	6 ports, USB Version 2.0
LPC I/O	Winbond W83627HF: Parallel x1, COM1 (RS-232), COM2 (RS-232/422/485), FDC 1.44MB (Slim), IrDA, Hardware monitoring
2nd LPC I/O	Fintek F81216: COM3, COM4 support RS-232
PCI to ISA bridge	Winbond 83628, 83629
Digital I/O	4in/4out
IrDA	Pin header
RTC/CMOS	Intel ICH4 built-in RTC with onboard Lithium battery
Local bus IDE	ICH4 built-in, IDE1/IDE2, (UDMA 33/66/100)
Type II CF socket	1 port using IDE2 Slave channel (PCB solder side)
Expansion slots	PCI slot x3, ISA slot x1, mini PCI slot x1
Audio	ICH4 Built-in Sound controller + AC97 Codec ALC 655 5.1 Channel (Line-out, Line-in & Mic.)
D-sub Connectors	DB15 x 1 for CRT RJ45+USB Connector x 2 DB25 x 1 for parallel port DB9 x 1 for COM1 Mini-DIN x 1 for PS/2 KB/MS Audio x 1 for Line-Out, MIC, (Line-In via pin header)
Watchdog Timer	Yes (256 segments: 0, 1, 2,..., 255 sec/min)
Power Connector	ATX (20 pin)
Dimensions	244mm x 244mm

Board Dimensions

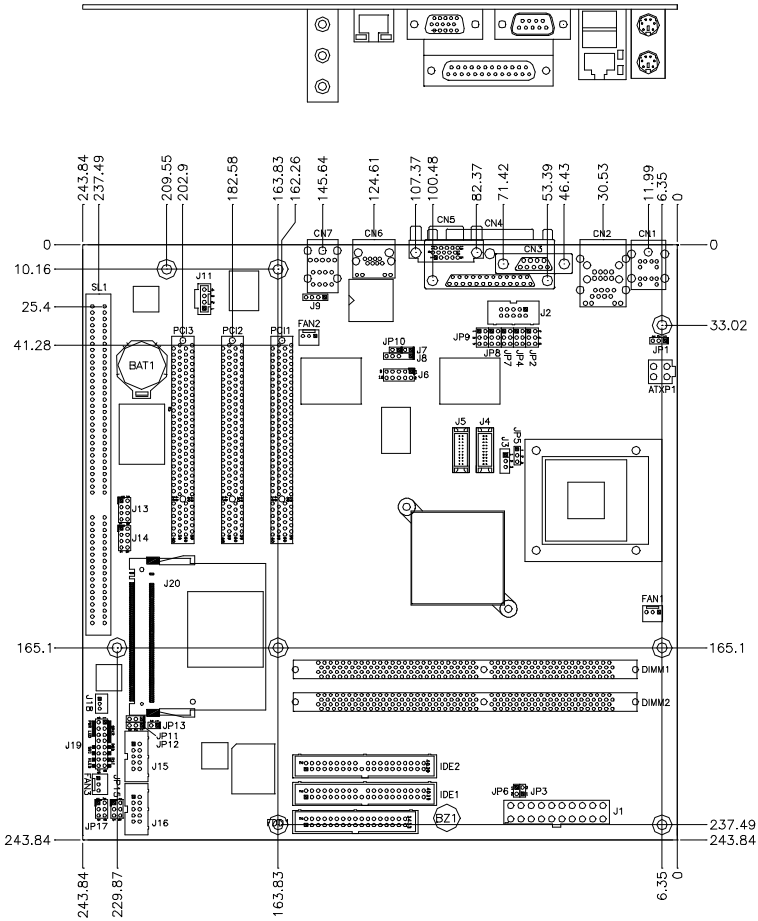

Installations

This section provides information on how to use the jumpers and connectors on the MB894 in order to set up a workable system. The topics covered are:

Installing the CPU	6
Installing the Memory.....	7
Setting the Jumpers.....	8
Connectors on MB894	13
Watchdog Timer Configuration	25

Installing the CPU

The MB894 motherboard supports a Socket 479 processor socket for Intel® Pentium® M or Celeron® M processors.

The processor socket comes with a screw to secure the processor. As shown in the left picture below, loosen the screw first before inserting the processor. Place the processor into the socket by making sure the notch on the corner of the CPU corresponds with the notch on the inside of the socket. Once the processor has slide into the socket, fasten the screw. Refer to the figures below.

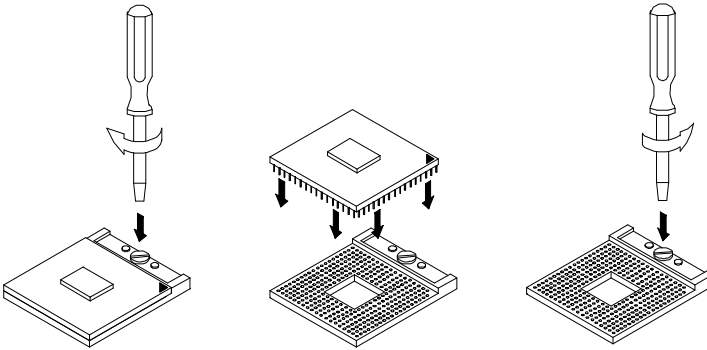

After you have installed the processor into the socket, check if the jumpers for the CPU type and speed are correct.

Installing the Memory

The MB894 Motherboard supports two DDR memory sockets for a maximum total memory of 2GB in DDR memory type. The memory module capacities supported are 64MB, 128MB, 256MB, 512MB and 1GB. The following table lists the supported DDR DIMM configurations. Intel 855GME supports configurations defined in the JEDEC DDR DIMM specification only (A,B,C). Non-JEDEC standard DIMMs such as double-sided x16 DDR SDRAM DIMMs are not supported.

Supported DDRM DIMM Configurations.

Density	64 Mbit		128Mbit		256Mbit		512Mbit	
Device Width	X8	X16	X8	X16	X8	X16	X8	X16
Single/Double	SS/DS	SS/DS	SS/DS	SS/DS	SS/DS	SS/DS	SS/DS	SS/DS
184-pin DDR	64/128MB	32MB/NA	128/256MB	64MB/NA	256/512MB	128MB/NA	512/1024M	256MB/NA

Installing and Removing Memory Modules

To install the DDR modules, locate the memory slot on the embedded board and perform the following steps:

1. Hold the DDR module so that the key of the DDR module align with those on the memory slot.
2. Gently push the DDR module in an upright position until the clips of the slot close to hold the DDR module in place when the DDR module touches the bottom of the slot.
3. To remove the DDR module, press the clips with both hands.

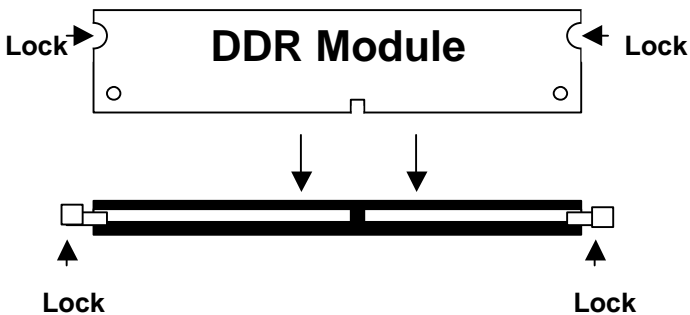

Setting the Jumpers

Jumpers are used on MB894 to select various settings and features according to your needs and applications. Contact your supplier if you have doubts about the best configuration for your needs. The following lists the connectors on MB894 and their respective functions.

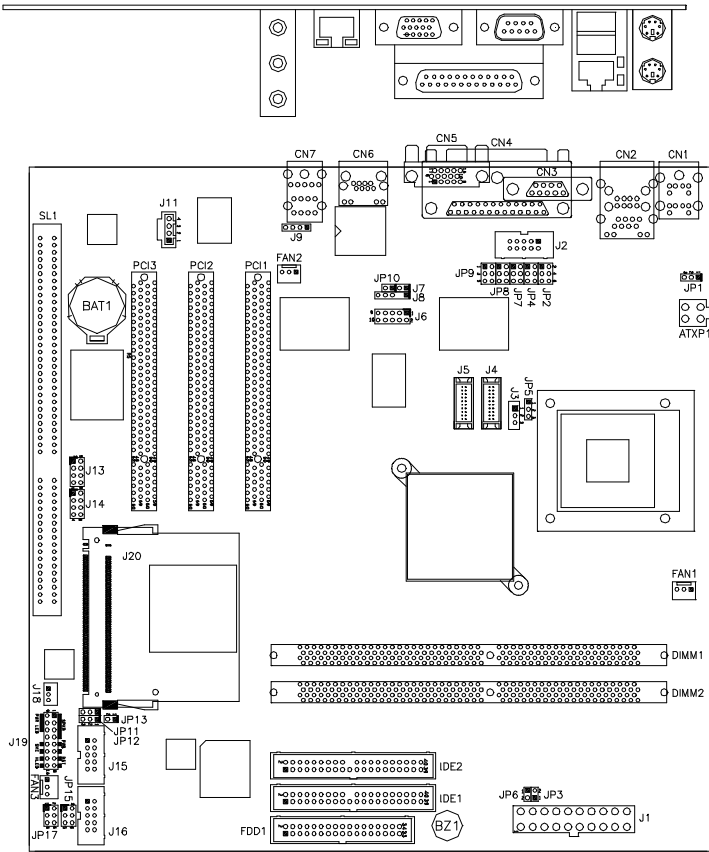

Jumper Locations on MB894	9
JP10: Processor Operating Frequency.....	10
JP2, JP4, JP7: RS232/422/485 (COM2) Selection	10
JP8: COM1 RS232 +5V / +12V Power Setting.....	10
JP9: COM2 RS232 +5V / +12V Power Setting.....	11
JP15: COM3 RS232 +5V / +12V Power Setting.....	11
JP17: COM4 RS232 +5V / +12V Power Setting.....	11
JP5: LVDS Panel Power Select	11
JP11: Clear CMOS Contents.....	12
JP13: Compact Flash Slave/Master	12

Jumper Locations on MB894



Jumpers on MB894.....	Page
JP10: Processor Operating Frequency.....	10
JP2, JP4, JP7: RS232/422/485 (COM2) Selection	10
JP8: COM1 RS232 +5V / +12V Power Setting.....	10
JP9: COM2 RS232 +5V / +12V Power Setting.....	11
JP15: COM3 RS232 +5V / +12V Power Setting.....	11
JP17: COM4 RS232 +5V / +12V Power Setting.....	11
JP5: LVDS Panel Power Select	11
JP11: Clear CMOS Contents.....	12
JP13: Compact Flash Slave/Master	12

JP10: Processor Operating Frequency

JP10	CPU Operating Frequency
 Open	133MHz
 Close	100MHz (default)

JP2, JP4, JP7: RS232/422/485 (COM2) Selection

COM1, COM3, and COM4 are fixed for RS-232 use only.

COM2 is selectable for RS232, RS-422 and RS-485.

The following table describes the jumper settings for COM2 selection.

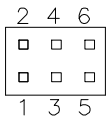

COM2 Function	RS-232	RS-422	RS-485
Jumper Setting (pin closed)	JP2: 1-2	JP2: 3-4	JP2: 5-6
	JP4: 3-5 & 4-6	JP4: 1-3 & 2-4	JP4: 1-3 & 2-4
	JP7: 3-5 & 4-6	JP7: 1-3 & 2-4	JP7: 1-3 & 2-4

JP8: COM1 RS232 +5V / +12V Power Setting

Pin #	Signal Name	JP8	Signal Name	Pin #
1	RI		+12V	2
3	RI (default)		RI (default)	4
5	RI		+5V	6

COM1 Settings: Pin 1-2 short = +12V, Pin 5-6 short = +5V,

Pin 3-4 short = standard COM port

JP9: COM2 RS232 +5V / +12V Power Setting

Pin #	Signal Name	JP9	Signal Name	Pin #
1	RI		+12V	2
3	RI (default)		RI (default)	4
5	RI		+5V	6

COM2 Settings: Pin 1-2 short = +12V, Pin 5-6 short = +5V,
Pin 3-4 short = standard COM port

JP15: COM3 RS232 +5V / +12V Power Setting

Pin #	Signal Name	JP15	Signal Name	Pin #
1	RI		+12V	2
3	RI (default)		RI (default)	4
5	RI		+5V	6

COM3 Settings: Pin 1-2 short = +12V, Pin 5-6 short = +5V,
Pin 3-4 short = standard COM port

JP17: COM4 RS232 +5V / +12V Power Setting

Pin #	Signal Name	JP17	Signal Name	Pin #
1	RI		+12V	2
3	RI (default)		RI (default)	4
5	RI		+5V	6

COM4 Settings: Pin 1-2 short = +12V, Pin 5-6 short = +5V,
Pin 3-4 short = standard COM port



JP5: LVDS Panel Power Select

JP1	LVDS Panel Power
	3.3V (default)
	5V



Note: The LVDS panel resolution can be configured in the BIOS Setup.

JP11: Clear CMOS Contents

Use JP11 to clear the CMOS contents. *Note that the ATX-power connector should be disconnected from the board before clearing CMOS.*

JP11	Setting	Function
 1 2 3	Pin 1-2 Short/Closed	Normal
 1 2 3	Pin 2-3 Short/Closed	Clear CMOS

JP13: Compact Flash Slave/Master

JP13	Compact Flash
 Open	Slave
 Close	Master

Connectors on MB894

The connectors on MB894 allows you to connect external devices such as keyboard, floppy disk drives, hard disk drives, printers, etc. The following table lists the connectors on MB894 and their respective functions.

Connector Locations on MB894	14
IDE1, IDE2: Primary and Secondary IDE Connectors	15
FDD1: Floppy Drive Connector	15
FAN1: CPU Fan Power Connector	16
FAN2: System Fan Power Connector	16
FAN3: Chassis Fan Power Connector	16
J1: ATX Power Supply Connector	16
CN3, J2, J15, J16: Serial Ports	17
J3: Panel Inverter Power Connector	17
J4, J5: LVDS Connectors (1st channel, 2nd channel)	18
J6: Digital 4-in 4-out I/O Connector	18
J8: IrDA Connector	18
J9: Line-In Audio Connector	18
J11: CD-In Audio Connector	20
J13, J14: USB Connectors	20
J18: Wake On LAN Connector	20
J19: System Function Connector	21
J20: Mini PCI Connector	22
CN1: PS/2 Keyboard and PS/2 Mouse Connectors	22
CN2: USB and LAN RJ45 Connectors	23
CN4: Parallel Port Connector	23
CN5: VGA CRT Connector	24
CN6: Gigabit LAN Connector (option)	24
CN7: Audio Connector	24
CN8: Compact Flash Connector	24

Connector Locations on MB894

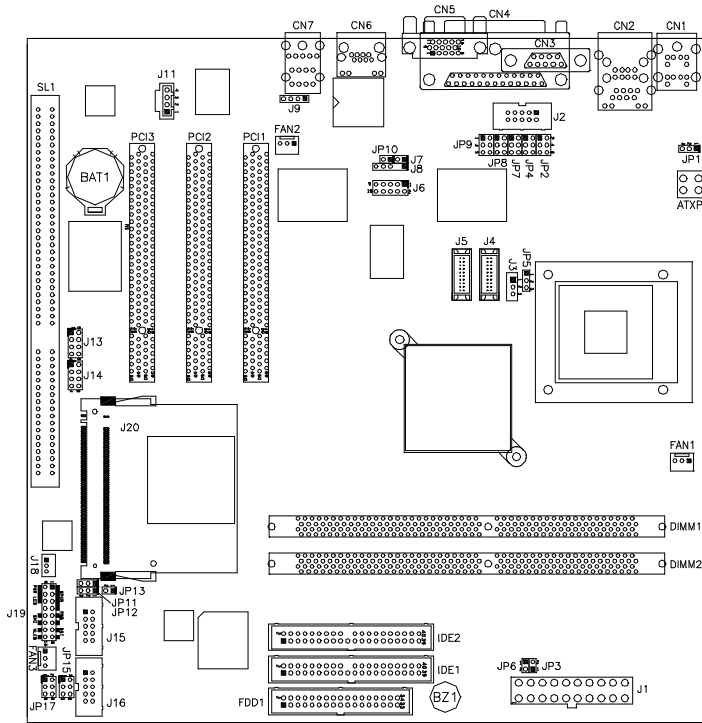

Connectors on MB894.....	Page
IDE1, IDE2: Primary and Secondary IDE Connectors.....	15
FDD1: Floppy Drive Connector.....	15
FAN1: CPU Fan Power Connector.....	16
FAN2: System Fan Power Connector.....	16
FAN3: Chassis Fan Power Connector.....	16
J1: ATX Power Connector.....	16
CN3, J2, J15, J16: Serial Ports.....	17
J3: Panel Inverter Power Connector.....	17
J4, J5: LVDS Connectors (1st channel, 2nd channel).....	18
J6: Digital 4-in 4-out I/O Connector.....	18
J8: IrDA Connector.....	18
J9: Line-In Audio Connector.....	18
J11: CD-In Audio Connector.....	20
J13, J14: USB Connectors.....	20
J18: Wake On LAN Connector.....	20
J19: System Function Connector.....	21
J20: Mini PCI Connector.....	22
CN1: PS/2 Keyboard and PS/2 Mouse Connectors.....	22
CN2: USB and LAN RJ45 Connectors.....	23
CN4: Parallel Port Connector.....	23
CN5: VGA CRT Connector.....	24
CN6: Gigabit LAN Connector (option).....	24
CN7: Audio Connector.....	24
CN8: Compact Flash Connector.....	24

IDE1, IDE2: Primary and Secondary IDE Connectors

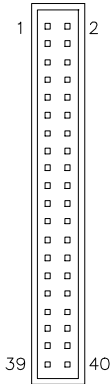

Signal Name	Pin #	Pin #	Signal Name
Reset IDE	1	2	Ground
Host data 7	3	4	Host data 8
Host data 6	5	6	Host data 9
Host data 5	7	8	Host data 10
Host data 4	9	10	Host data 11
Host data 3	11	12	Host data 12
Host data 2	13	14	Host data 13
Host data 1	15	16	Host data 14
Host data 0	17	18	Host data 15
Ground	19	20	Protect pin
DRQ0	21	22	Ground
Host IOW	23	24	Ground
Host IOR	25	26	Ground
IOCHRDY	27	28	Host ALE
DACK0	29	30	Ground
IRQ14	31	32	No connect
Address 1	33	34	No connect
Address 0	35	36	Address 2
Chip select 0	37	38	Chip select 1
Activity	39	40	Ground

FDD1: Floppy Drive Connector

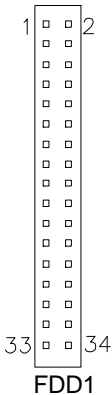

Signal Name	Pin #	Pin #	Signal Name
Ground	1	2	RM/LC
Ground	3	4	No connect
Ground	5	6	No connect
Ground	7	8	Index
Ground	9	10	Motor enable 0
Ground	11	12	Drive select 1
Ground	13	14	Drive select 0
Ground	15	16	Motor enable 1
Ground	17	18	Direction
Ground	19	20	Step
Ground	21	22	Write data
Ground	23	24	Write gate
Ground	25	26	Track 00
Ground	27	28	Write protect
Ground	29	30	Read data
Ground	31	32	Side 1 select
Ground	33	34	Diskette change

FAN1: CPU Fan Power Connector

FAN1 is a 3-pin header for CPU fan power. The fan must be a 12V (500mA) fan.

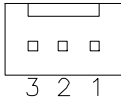

Pin #	Signal Name
1	Ground
2	+12V
3	Rotation detection

FAN2: System Fan Power Connector

FAN2 is a 3-pin header for system fan power. The fan must be a 12V (500mA) fan.

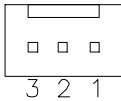

Pin #	Signal Name
1	Ground
2	+12V
3	Rotation detection

FAN3: Chassis Fan Power Connector

FAN3 is a 3-pin header for chassis fan power. The fan must be a 12V (500mA) fan.

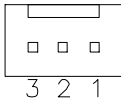

Pin #	Signal Name
1	Ground
2	+12V
3	Rotation detection

J1: ATX Power Supply Connector

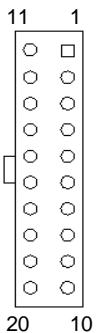

Signal Name	Pin #	Pin #	Signal Name
3.3V	11	1	3.3V
-12V	12	2	3.3V
Ground	13	3	Ground
PS-ON	14	4	+5V
Ground	15	5	Ground
Ground	16	6	+5V
Ground	17	7	Ground
-5V	18	8	Power good
+5V	19	9	5VSB
+5V	20	10	+12V

CN3, J2, J15, J16: Serial Ports

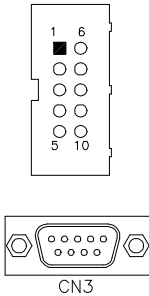

Pin #	Signal Name (RS-232)
1	DCD, Data carrier detect
2	RXD, Receive data
3	TXD, Transmit data
4	DTR, Data terminal ready
5	Ground
6	DSR, Data set ready
7	RTS, Request to send
8	CTS, Clear to send
9	RI, Ring indicator
10	No Connect.

CN3 is the D-sub type COM1 serial port connector, while J2 (COM2), J15 (COM3) and J16 (COM4) are shrouded pin headers.

COM2 is jumper selectable for RS-232, RS-422 and RS-485.

Pin #	Signal Name		
	RS-232	R2-422	RS-485
1	DCD	TX-	DATA-
2	RX	TX+	DATA+
3	TX	RX+	NC
4	DTR	RX-	NC
5	Ground	Ground	Ground
6	DSR	RTS-	NC
7	RTS	RTS+	NC
8	CTS	CTS+	NC
9	RI	CTS-	NC
10	NC	NC	NC

J3: Panel Inverter Power Connector

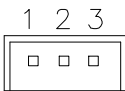

Pin #	Signal Name
1	+12V
2	ENABKL
3	Ground

J4, J5: LVDS Connectors (1st channel, 2nd channel)

The LVDS connectors are composed of the first channel (J4) and second channel (J5) to support 24-bit or 48-bit.

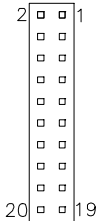

Signal Name	Pin #	Pin #	Signal Name
TX0-	2	1	TX0+
Ground	4	3	Ground
TX1-	6	5	TX1+
5V/3.3V	8	7	Ground
TX3-	10	9	TX3+
TX2-	12	11	TX2+
Ground	14	13	Ground
TXC-	16	15	TXC+
5V/3.3V	18	17	ENABKL
+12V	20	19	+12V

J6: Digital 4-in 4-out I/O Connector

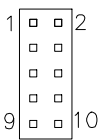

Signal Name	Pin	Pin	Signal Name
Ground	1	2	Vcc
Out3	3	4	Out1
Out2	5	6	Out0
Int3	7	8	Int1
Int2	9	10	Int0

J8: IrDA Connector

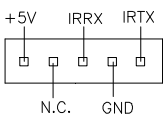

Pin #	Signal Name
1	+5V
2	No connect
3	Ir RX
4	Ground
5	Ir TX

J9: Line-In Audio Connector



Pin #	Signal Name
1	Line_R
2	Ground
3	Ground
4	Line_L

J11: CD-In Audio Connector

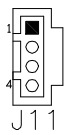

Pin #	Signal Name
1	CD Audio L
2	Ground
3	Ground
4	CD Audio R

J13, J14: USB Connectors

The following table shows the pin outs of the USB pin headers connectors. Overall, the two pin headers support four USB ports (USB 2.0 compliant).

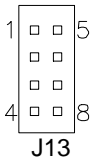

Signal Name	Pin	Pin	Signal Name
Vcc	1	5	Ground
USB0-	2	6	USB1+
USB0+	3	7	USB1-
Ground	4	8	Vcc

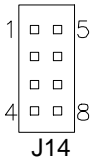

Signal Name	Pin	Pin	Signal Name
Vcc	1	5	Ground
USB2-	2	6	USB3+
USB2+	3	7	USB3-
Ground	4	8	Vcc

J18: Wake On LAN Connector

J18 is a 3-pin header for the Wake On LAN function on the CPU card. The following table shows the pin out assignments of this connector. Wake On LAN will function properly only with an ATX power supply with 5VSB that has 200mA.

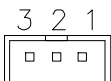

Pin #	Signal Name
1	+5VSB
2	Ground
3	-PME

J19: System Function Connector

J19 provides connectors for system indicators that provide light indication of the computer activities and switches to change the computer status. J5 is a 16-pin header that provides interfaces for the following functions.

Speaker: Pins 1 - 4

This connector provides an interface to a speaker for audio tone generation. An 8-ohm speaker is recommended.

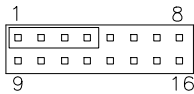

Pin #	Signal Name
1	Speaker out
2	No connect
3	Ground
4	+5V

Power LED: Pins 9-11

The indicates the status of the main power switch.

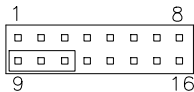

Pin #	Signal Name
9	Power LED
10	NC
11	Ground

ATX Power ON Switch: Pins 5 and 13

This 2-pin connector is an “ATX Power Supply On/Off Switch” on the system that connects to the power switch on the case. When pressed, the power switch will force the system to power on. When pressed again, it will force the system to power off.

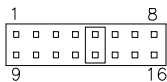

Pin #	Signal Name
5	PS_ON
13	Ground

SMI/Hardware Switch: Pins 6 and 14

This connector supports the "Green Switch" on the control panel, which, when pressed, will force the system into the power-saving mode immediately.

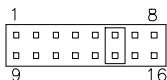

Pin #	Signal Name
6	SMI
14	Ground

Reset Switch: Pins 7 and 15

The reset switch allows the user to reset the system without turning the main power switch off and then on again.

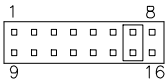

Pin #	Signal Name
7	Reset#
15	Ground

Hard Disk Drive LED Connector: Pins 8 and 16

This connects to the hard drive activity LED on control panel. This LED will flash when HDD is being accessed.

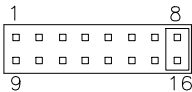

Pin #	Signal Name
8	HDD Active
16	5V

J20: Mini PCI Connector

CN1: PS/2 Keyboard and PS/2 Mouse Connectors

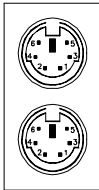

PS/2 Mouse

PS/2 Keyboard

Signal Name	Keyboard	Mouse	Signal Name
Keyboard data	1	1	Mouse data
N.C.	2	2	N.C.
GND	3	3	GND
5V	4	4	5V
Keyboard clock	5	5	Mouse clock
N.C.	6	6	N.C.

CN2: USB and LAN RJ45 Connectors

CN2 consists of an RJ-45 connector (top) and two stacked USB ports. Refer to the section below for their respective pin assignments.

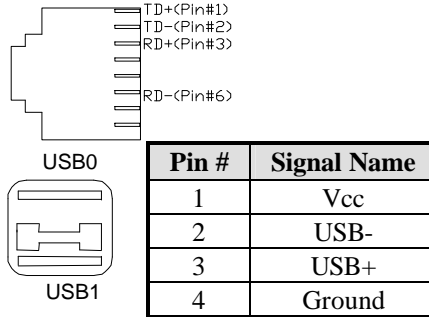

CN4: Parallel Port Connector

CN4 is a DB-25 external connector on top of the VGA and serial ports.

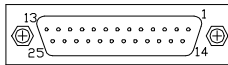

Signal Name	Pin #	Pin #	Signal Name
Line printer strobe	1	14	AutoFeed
PD0, parallel data 0	2	15	Error
PD1, parallel data 1	3	16	Initialize
PD2, parallel data 2	4	17	Select
PD3, parallel data 3	5	18	Ground
PD4, parallel data 4	6	19	Ground
PD5, parallel data 5	7	20	Ground
PD6, parallel data 6	8	21	Ground
PD7, parallel data 7	9	22	Ground
ACK, acknowledge	10	23	Ground
Busy	11	24	Ground
Paper empty	12	25	Ground
Select	13	N/A	N/A

CN5: VGA CRT Connector

CN5 is a DB-15 VGA connector located beside the COM1 port.

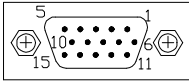

Signal Name	Pin #	Pin #	Signal Name
Red	1	2	Green
Blue	3	4	N.C.
GND	5	6	GND
GND	7	8	GND
N.C.	9	10	GND
N.C.	11	12	DDC Data
HSYNC	13	14	VSYNC
DDC Clk	15		

CN6: Gigabit LAN Connector (option)

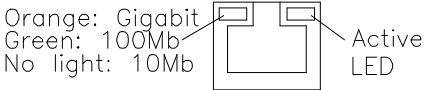

CN7: Audio Connector

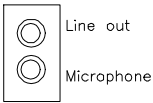

CN8: Compact Flash Connector

CN8 uses the IDE2 channel.

Watchdog Timer Configuration

The WDT is used to generate a variety of output signals after a user programmable count. The WDT is suitable for use in the prevention of system lock-up, such as when software becomes trapped in a deadlock. Under these sort of circumstances, the timer will count to zero and the selected outputs will be driven. Under normal circumstance, the user will restart the WDT at regular intervals before the timer counts to zero.

SAMPLE CODE:

This code and information is provided "as is" without warranty of any kind, either expressed or implied, including but not limited to the implied warranties of merchantability and/or fitness for a particular purpose.

```

:[]=====
; Name   : Enable_And_Set_Watchdog
; IN    : AL - 1sec ~ 255sec
; OUT   : None
:[]=====
Enable_And_Set_Watchdog Proc Near
    pushax                ;save time interval
    call Unlock_Chip

    mov cl, 2Bh
    call Read_Reg
    and al, NOT 10h
    call Write_Reg        ;set GP24 as WDTO

    mov cl, 07h
    mov al, 08h
    call Write_Reg        ;switch to LD8
    mov cl, 0F5h
    call Read_Reg
    and al, NOT 08h
    call Write_Reg        ;set count mode as second

    pop ax
    mov cl, 0F6h
    call Write_Reg        ;set watchdog timer

    mov al, 01h
    mov cl, 30h

```

call Write_Reg ;watchdog enabled

```

        call Lock_Chip
        ret
Enable_And_Set_Watchdog Endp
;[]=====
; Name   : Disable_Watchdog
; IN    : None
; OUT   : None
;[]=====
Disable_Watchdog Proc Near
        call Unlock_Chip

        mov cl, 07h
        mov al, 08h
        call Write_Reg      ;switch to LD8

        xor al, al
        mov cl, 0F6h
        call Write_Reg      ;clear watchdog timer

        xor al, al
        mov cl, 30h
        call Write_Reg      ;watchdog disabled

        call Lock_Chip
        ret
Disable_Watchdog Endp
;[]=====
; Name   : Unlock_Chip
; IN    : None
; OUT   : None
;[]=====
Unlock_Chip Proc Near
        Mov dx, 4Eh
        mov al, 87h
        out dx, al
        out dx, al
        ret
Unlock_Chip Endp
;[]=====
; Name   : Lock_Chip
; IN    : None
; OUT   : None
;[]=====
Unlock_Chip Proc Near
        mov dx, 4Eh
        mov al, 0Aah

```

```
        out dx, al
        ret
Unlock_Chip Endp
;[]=====
;Name   : Write_Reg
;IN  : CL - register index
;      AL - Value to write
;OUT   : None
;[]=====
Write_Reg Proc Near
        pushax
        mov dx, 4Eh
        mov al,cl
        out dx,al
        pop ax
        inc dx
        out dx,al
        ret
Write_Reg Endp
;[]=====
;Name   : Read_Reg
;IN  : CL - register index
;OUT   : AL - Value to read
;[]=====
Read_Reg Proc Near
        Mov al, cl
        mov dx, 4Eh
        out dx, al
        inc dx
        in  al, dx
        ret
Read_Reg Endp
;[]=====
```

BIOS Setup

This chapter describes the different settings available in the Award BIOS that comes with the board. The topics covered in this chapter are as follows:

BIOS Introduction	30
BIOS Setup	30
Standard CMOS Setup	32
Advanced BIOS Features.....	35
Advanced Chipset Features	38
Integrated Peripherals	41
Power Management Setup	45
PNP/PCI Configurations	48
PC Health Status	49
Frequency/Voltage Control.....	50
Load Fail-Safe Defaults.....	51
Load Optimized Defaults.....	51
Set Supervisor/User Password	51
Save & Exit Setup	51
Exit Without Saving.....	51

BIOS Introduction

The Award BIOS (Basic Input/Output System) installed in your computer system's ROM supports Intel Pentium 4 processors. The BIOS provides critical low-level support for a standard device such as disk drives, serial ports and parallel ports. It also adds virus and password protection as well as special support for detailed fine-tuning of the chipset controlling the entire system.

BIOS Setup

The Award BIOS provides a Setup utility program for specifying the system configurations and settings. The BIOS ROM of the system stores the Setup utility. When you turn on the computer, the Award BIOS is immediately activated. Pressing the key immediately allows you to enter the Setup utility. If you are a little bit late pressing the key, POST (Power On Self Test) will continue with its test routines, thus preventing you from invoking the Setup. If you still wish to enter Setup, restart the system by pressing the "Reset" button or simultaneously pressing the <Ctrl>, <Alt> and <Delete> keys. You can also restart by turning the system Off and back On again. The following message will appear on the screen:

Press to Enter Setup

In general, you press the arrow keys to highlight items, <Enter> to select, the <PgUp> and <PgDn> keys to change entries, <F1> for help and <Esc> to quit.

When you enter the Setup utility, the Main Menu screen will appear on the screen. The Main Menu allows you to select from various setup functions and exit choices.

Phoenix - AwardBIOS CMOS Setup Utility

Standard CMOS Features	Frequency/Voltage Control
Advanced BIOS Features	Load Fail-Safe Defaults
Advanced Chipset Features	Load Optimized Defaults
Integrated Peripherals	Set Supervisor Password
Power Management Setup	Set User Password
PnP/PCI Configurations	Save & Exit Setup
PC Health Status	Exit Without Saving
ESC : Quit	↑ ↓ → ← : Select Item
F10 : Save & Exit Setup	
Time, Date, Hard Disk Type...	

The section below the setup items of the Main Menu displays the control keys for this menu. At the bottom of the Main Menu just below the control keys section, there is another section, which displays information on the currently highlighted item in the list.

Note: *If the system cannot boot after making and saving system changes with Setup, the Award BIOS supports an override to the CMOS settings that resets your system to its default.*

Warning: *It is strongly recommended that you avoid making any changes to the chipset defaults. These defaults have been carefully chosen by both Award and your system manufacturer to provide the absolute maximum performance and reliability. Changing the defaults could cause the system to become unstable and crash in some cases.*

Standard CMOS Setup

“Standard CMOS Setup” choice allows you to record some basic hardware configurations in your computer system and set the system clock and error handling. If the motherboard is already installed in a working system, you will not need to select this option. You will need to run the Standard CMOS option, however, if you change your system hardware configurations, the onboard battery fails, or the configuration stored in the CMOS memory was lost or damaged.

Phoenix - AwardBIOS CMOS Setup Utility
Standard CMOS Features

Date (mm:dd:yy)	Wed, Apr 28, 2004	Item Help
Time (hh:mm:ss)	00 : 00 : 00	Menu Level >
IDE Primary Master	None	Change the day, month, Year and century
IDE Primary Slave	None	
IDE Secondary Master	None	
IDE Secondary Slave	None	
Drive A	1.44M, 3.5 in.	
Drive B	None	
Video	EGA/VGA	
Halt On	All, But Keyboard	
Base Memory	640K	
Extended Memory	129024K	
Total Memory	130048K	

At the bottom of the menu are the control keys for use on this menu. If you need any help in each item field, you can press the <F1> key. It will display the relevant information to help you. The memory display at the lower right-hand side of the menu is read-only. It will adjust automatically according to the memory changed. The following describes each item of this menu.

Date

The date format is:

Day : Sun to Sat
Month : 1 to 12
Date : 1 to 31
Year : 1999 to 2099

To set the date, highlight the “Date” field and use the PageUp/PageDown or +/- keys to set the current time.

Time

The time format is: **Hour : 00 to 23**

Minute : 00 to 59

Second : 00 to 59

To set the time, highlight the “Time” field and use the <PgUp>/<PgDn> or +/- keys to set the current time.

IDE Primary HDDs / IDE Secondary HDDs

The onboard PCI IDE connectors provide Primary and Secondary channels for connecting up to four IDE hard disks or other IDE devices. Each channel can support up to two hard disks; the first is the “Master” and the second is the “Slave”.

Press <Enter> to configure the hard disk. The selections include Auto, Manual, and None. Select ‘Manual’ to define the drive information manually. You will be asked to enter the following items.

CYLS : Number of cylinders
HEAD : Number of read/write heads
PRECOMP : Write precompensation
LANDING ZONE : Landing zone
SECTOR : Number of sectors

The Access Mode selections are as follows:

CHS (HD < 528MB)

LBA (HD > 528MB and supports Logical Block Addressing)

Large (for MS-DOS only)

Auto

Remarks: The board supports two serial ATA ports that are represented in this setting as IDE Channel 2 / 3 Master.

Drive A / Drive B

These fields identify the types of floppy disk drive A or drive B that has been installed in the computer. The available specifications are:

360KB 1.2MB 720KB 1.44MB 2.88MB
 5.25 in. 5.25 in. 3.5 in. 3.5 in. 3.5 in.

Video

This field selects the type of video display card installed in your system.

You can choose the following video display cards:

EGA/VGA	For EGA, VGA, SEGA, SVGA or PGA monitor adapters. (default)
CGA 40	Power up in 40 column mode.
CGA 80	Power up in 80 column mode.
MONO	For Hercules or MDA adapters.

Halt On

This field determines whether or not the system will halt if an error is detected during power up.

No errors	The system boot will not be halted for any error that may be detected.
All errors	Whenever the BIOS detects a non-fatal error, the system will stop and you will be prompted.
All, But Keyboard	The system boot will not be halted for a keyboard error; it will stop for all other errors
All, But Diskette	The system boot will not be halted for a disk error; it will stop for all other errors.
All, But Disk/Key	The system boot will not be halted for a keyboard or disk error; it will stop for all others.

Advanced BIOS Features

This section allows you to configure and improve your system and allows you to set up some system features according to your preference.

Phoenix - AwardBIOS CMOS Setup Utility
Advanced BIOS Features

	Press Enter	ITEM HELP
CPU Feature		Menu Level >
Virus Warning	Disabled	
CPU L1 and L2 Cache	Enabled	
Quick Power On Self Test	Enabled	
First Boot Device	Floppy	
Second Boot Device	HDD-0	
Third Boot Device	CDROM	
Boot Other Device	Enabled	
Swap Floppy Drive	Disabled	
Boot Up Floppy Seek	Disabled	
Boot Up NumLock Status	On	
Gate A20 Option	Fast	
Typematic Rate Setting	Disabled	
Typematic Rate (Chars/Sec)	6	
Typematic Delay (Msec)	250	
Security Option	Setup	
APIC Mode	Enabled	
MPS Version Control for OS	1.4	
OS Select For DRAM>64MB	Non-OS2	
Report No FDD For WIN 95	Yes	
Small Logo (EPA) Show	Enabled	

CPU Feature

Press Enter to configure the settings relevant to CPU Feature.

Virus Warning

If this option is enabled, an alarm message will be displayed when trying to write on the boot sector or on the partition table on the disk, which is typical of the virus.

CPU L1 and L2 Cache

Cache memory is additional memory that is much faster than conventional DRAM (system memory). CPUs from 486-type on up contain internal cache memory, and most, but not all, modern PCs have additional (external) cache memory. When the CPU requests data, the system transfers the requested data from the main DRAM into cache memory, for even faster access by the CPU. These items allow you to enable (speed up memory access) or disable the cache function. By default, these items are Enabled.

Quick Power On Self Test

When enabled, this field speeds up the Power On Self Test (POST) after the system is turned on. If it is set to Enabled, BIOS will skip some items.

First/Second/Third Boot Device

These fields determine the drive that the system searches first for an operating system. The options available include *Floppy*, *LS120*, *HDD-0*, *SCSI*, *CDROM*, *HDD-1*, *HDD-2*, *HDD-3*, *ZIP100*, *USB-FDD*, *USB-ZIP*, *USB-CDROM*, *USB-HDD* and *Disable*.

Boot Other Device

These fields allow the system to search for an OS from other devices other than the ones selected in the First/Second/Third Boot Device.

Swap Floppy Drive

This item allows you to determine whether or not to enable Swap Floppy Drive. When enabled, the BIOS swaps floppy drive assignments so that Drive A becomes Drive B, and Drive B becomes Drive A. By default, this field is set to *Disabled*.

Boot Up Floppy Seek

This feature controls whether the BIOS checks for a floppy drive while booting up. If it cannot detect one (either due to improper configuration or its absence), it will flash an error message.

Boot Up NumLock Status

This allows you to activate the NumLock function after you power up the system.

Gate A20 Option

This field allows you to select how Gate A20 is worked. Gate A20 is a device used to address memory above 1 MB.

Typematic Rate Setting

When disabled, continually holding down a key on your keyboard will generate only one instance. When enabled, you can set the two typematic controls listed next. By default, this field is set to *Disabled*.

Typematic Rate (Chars/Sec)

When the typematic rate is enabled, the system registers repeated keystrokes speeds. Settings are from 6 to 30 characters per second.

Typematic Delay (Msec)

When the typematic rate is enabled, this item allows you to set the time interval for displaying the first and second characters. By default, this item is set to *250msec*.

Security Option

This field allows you to limit access to the System and Setup. The default value is *Setup*. When you select *System*, the system prompts for the User Password every time you boot up. When you select *Setup*, the system always boots up and prompts for the Supervisor Password only when the Setup utility is called up.

APIC Mode

APIC stands for Advanced Programmable Interrupt Controller. The default setting is *Enabled*.

MPS Version Control for OS

This option specifies the MPS (Multiprocessor Specification) version for your operating system. MPS version 1.4 added extended configuration tables to improve support for multiple PCI bus configurations and improve future expandability. The default setting is *1.4*.

OS Select for DRAM > 64MB

This option allows the system to access greater than 64MB of DRAM memory when used with OS/2 that depends on certain BIOS calls to access memory. The default setting is *Non-OS/2*.

Report No FDD For WIN 95

If you are using Windows 95/98 without a floppy disk drive, select *Enabled* to release IRQ6. This is required to pass Windows 95/98's SCT test. You should also disable the Onboard FDC Controller in the Integrated Peripherals screen when there's no floppy drive in the system. If you set this feature to *Disabled*, the BIOS will not report the missing floppy drive to Win95/98.

Small Logo (EPA) Show

The EPA logo appears at the right side of the monitor screen when the system is boot up. The default setting is *Enabled*.

Advanced Chipset Features

This Setup menu controls the configuration of the chipset.

Phoenix - AwardBIOS CMOS Setup Utility
Advanced Chipset Features

DRAM Timing Selectable	By SPD	ITEM HELP
CAS Latency Time	2	Menu Level >
Active to Precharge Delay	6	
DRAM RAS# to CAS# Delay	3	
DRAM RAS# Precharge	3	
DRAM Data Integrity Mode	ECC	
MGM Core Frequency	Auto Max 266MHz	
System BIOS Cacheable	Enabled	
Video BIOS Cacheable	Enabled	
Memory Hole at 15M-16M	Disabled	
Delayed Transaction	Enabled	
Delay Prior to Thermal	16 Min	
AGP Aperture Size (MB)	128	
** On-Chip VGA Setting **		
On-Chip VGA	Enabled	
On-Chip Frame Buffer Size	32MB	
Boot Display	CRT+LFP	
Panel Scaling	Auto	
Panel Number	1024x768 18bit SC	

DRAM Timing Selectable

This option refers to the method by which the DRAM timing is selected. The default is **By SPD**.

CAS Latency Time

You can configure CAS latency time in HCLKs as 2 or 2.5 or 3. The system board designer should set the values in this field, depending on the DRAM installed. Do not change the values in this field unless you change specifications of the installed DRAM or the installed CPU.

Active to Precharge Delay

The default setting for the Active to Precharge Delay is 7.

DRAM RAS# to CAS# Delay

This option allows you to insert a delay between the RAS (Row Address Strobe) and CAS (Column Address Strobe) signals. This delay occurs when the SDRAM is written to, read from or refreshed. Reducing the delay improves the performance of the SDRAM.

DRAM RAS# Precharge

This option sets the number of cycles required for the RAS to accumulate its charge before the SDRAM refreshes. The default setting for the Active to Precharge Delay is **3**.

DRAM Data Integrity Mode

Select ECC if your memory module supports it. The memory controller will detect and correct single-bit soft memory errors. The memory controller will also be able to detect double-bit errors though it will not be able to correct them. This provides increased data integrity and system stability.

MGM Core Frequency

This field sets the frequency of the DRAM memory installed. The default setting is **Auto Max 266MHz**.

System BIOS Cacheable

The setting of *Enabled* allows caching of the system BIOS ROM at F000h-FFFFh, resulting in better system performance. However, if any program writes to this memory area, a system error may result.

Video BIOS Cacheable

The Setting *Enabled* allows caching of the video BIOS ROM at C0000h-F7FFFh, resulting in better video performance. However, if any program writes to this memory area, a system error may result.

Memory Hole At 15M-16M

In order to improve performance, certain space in memory can be reserved for ISA cards. This memory must be mapped into the memory space below 16 MB. The choices are *Enabled* and *Disabled*.

Delayed Transaction

The chipset has an embedded 32-bit posted write buffer to support delay transactions cycles. Select *Enabled* to support compliance with PCI specification version 2.1.

Delay Prior to Thermal

This field activates the CPU thermal function after the systems boots for the set number of minutes. The options are *16Min* and *64Min*.

AGP Aperture Size

The field sets aperture size of the graphics. The aperture is a portion of the PCI memory address range dedicated for graphics memory address space. Host cycles that hit the aperture range are forwarded to the AGP without any translation. The default setting is *128M*.

On-Chip VGA

The default setting is *Enabled*.

On-Chip Frame Buffer Size

The default setting is *32MB*. The options available include *1MB*, *4MB*, *8MB* and *16MB*.

Boot Display

The default setting is *CRT+LFP*. The options available include *CRT* and *LVDS*.

Panel Scaling

The default setting is *Auto*. The options available include *On* and *Off*.

Panel Number

These fields allow you to select the LCD Panel type. The default values for these ports are:

640x480	18bit SC
800x600	18bit SC
1024x768	18bit SC
1280x1024	24bit DC
1400x1050	18bit DC
1024x768	24bit SC
1600x1200	24bit DC
1280x1024	18bit DC

Integrated Peripherals

This section sets configurations for your hard disk and other integrated peripherals. The first screen shows three main items for user to select. Once an item selected, a submenu appears. Details follow.

Phoenix - AwardBIOS CMOS Setup Utility
Integrated Peripherals

OnChip IDE Device	Press Enter	ITEM HELP
Onboard Device	Press Enter	Menu Level >
SuperIO Device	Press Enter	
SecondIO Device	Press Enter	

Phoenix - AwardBIOS CMOS Setup Utility
OnChip IDE Device

Onboard SATA chip mode	SATA mode	ITEM HELP
On-Chip Primary PCI IDE	Enabled	Menu Level >
IDE Primary Master PIO	Auto	
IDE Primary Slave PIO	Auto	
IDE Primary Master UDMA	Auto	
IDE Primary Slave UDMA	Auto	
On-Chip Secondary PCI IDE	Enabled	
IDE Secondary Master PIO	Auto	
IDE Secondary Slave PIO	Auto	
IDE Secondary Master UDMA	Auto	
IDE Secondary Slave UDMA	Auto	
IDE HDD Block Mode	Enabled	

Phoenix - AwardBIOS CMOS Setup Utility
Onboard Device

USB Controller	Enabled	ITEM HELP
USB 2.0 Controller	Enabled	Menu Level >
USB Keyboard Support	Disabled	
USB Mouse Support	Disabled	
AC97 Audio	Auto	
Integrated LAN	Enabled	
Init Display First	PCI Slot	

Phoenix - AwardBIOS CMOS Setup Utility
SuperIO Device

	BUTTON ONLY	ITEM HELP
POWER ON Function	Ctrl-F1	Menu Level >
Hot Key Power ON	Enabled	
Onboard FDC Controller	3F8/IRQ4	
Onboard Serial Port 1	2F8/IRQ3	
Onboard Serial Port 2	Normal	
UART Mode Select	Hi, Lo	
RxD , TxD Active	Disabled	
IR Transmission Delay	Half	
UR2 Duplex Mode	IR-Rx2Tx2	
Use IR Pins	378/IRQ7	
Onboard Parallel Port	SPP	
Parallel Port Mode	EPP1.7	
EPP Mode Select	3	
ECP Mode Use DMA	3E8	
Onboard Serial Port 3	IRQ10	
Serial Port 3 Use IRQ	Disabled	
Onboard Serial Port 4	IRQ11	
Serial Port 4 Use IRQ	Off	
PWRON After PWR-Fail		

Onboard SATA chip Mode

This field, by default, is set to SATA.

OnChip Primary/Secondary PCI IDE

The integrated peripheral controller contains an IDE interface with support for two IDE channels. Select *Enabled* to activate each channel separately.

IDE Primary/Secondary Master/Slave PIO

These fields allow your system hard disk controller to work faster. Rather than have the BIOS issue a series of commands that transfer to or from the disk drive, PIO (Programmed Input/Output) allows the BIOS to communicate with the controller and CPU directly.

The system supports five modes, numbered from 0 (default) to 4, which primarily differ in timing. When Auto is selected, the BIOS will select the best available mode.

IDE Primary/Secondary Master/Slave UDMA

These fields allow your system to improve disk I/O throughput to 33Mb/sec with the Ultra DMA/33 feature. The options are *Auto* and *Disabled*.

IDE HDD Block Mode

This field allows your hard disk controller to use the fast block mode to transfer data to and from your hard disk drive.

USB Controller

The options for this field are *Enabled* and *Disabled*. By default, this field is set to *Enabled*.

USB 2.0 Controller

The options for this field are *Enabled* and *Disabled*. By default, this field is set to *Enabled*. In order to use USB 2.0, necessary OS drivers must be installed first. *Please update your system to Windows 2000 SP4 or Windows XP SP1.*

USB Keyboard Support

The options for this field are *Enabled* and *Disabled*. By default, this field is set to *Disabled*.

USB Mouse Support

The options for this field are *Enabled* and *Disabled*. By default, this field is set to *Disabled*.

AC97 Audio

The default setting of the AC97 Audio is *Auto*.

Integrated LAN

The default setting of the LAN controller is *Enabled*.

Init Display First

The default setting is *PCI Card*. This determines which VGA controller is initialized when the system boots.

POWER ON Function

This field allows the type of power on function as the method to power on the system. The selections in this setting are Hot KEY, Mouse Left, Mouse Right, Any KEY, BUTTON ONLY and Keyboard w.

Hot Key Power ON

This allows the setting of certain keys on the keyboard that will serve as the hot keys, that when pressed could power on the system.

Onboard FDC Controller

Select *Enabled* if your system has a floppy disk controller (FDC) installed on the motherboard and you wish to use it. If you install an add-in FDC or the system has no floppy drive, select *Disabled* in this field. This option allows you to select the onboard FDD port.

Onboard Serial/Parallel Port

These fields allow you to select the onboard serial and parallel ports and their addresses. The default values for these ports are:

Serial Port 1	3F8/IRQ4
Serial Port 2	2F8/IRQ3
Serial Port 3	3E8/IRQ10
Serial Port 4	2E8/IRQ11
Parallel Port	378H/IRQ7

UART Mode Select

This field determines the UART 2 mode in your computer. The default value is *Normal*. Other options include *IrDA* and *ASKIR*.

Parallel Port Mode

This field allows you to determine parallel port mode function.

SPP	Standard Printer Port
EPP	Enhanced Parallel Port
ECP	Extended Capabilities Port

PWRON After PWR-Fail

This field sets the system power status whether on or off when power returns from a power failure situation.

Power Management Setup

The Power Management Setup allows you to save energy of your system effectively.

Phoenix - AwardBIOS CMOS Setup Utility
Power Management Setup

Power-Supply Type	ATX	ITEM HELP
ACPI Function	Enabled	
Power Management	User Define	Menu Level >
Video Off Method	V/H SYNC+Blank	
Video Off In Suspend	Yes	
Suspend Type	Stop Grant	
Modem Use IRQ	3	
Suspend Mode	Disabled	
HDD Power Down	Disabled	
Soft-Off by PWR-BTTN	Instant-Off	
CPU THRM-Throttling	50%	
Wake-Up by PCI Card	Disabled	
Power On by Ring	Disabled	
Resume by Alarm	Disabled	
Date (of Month) Alarm	0	
Time (hh:mm:ss) Alarm	0 : 0 : 0	
** Reload Global Timer Events **		
Primary IDE 0	Enabled	
Primary IDE 1	Enabled	
Secondary IDE 0	Enabled	
Secondary IDE 1	Enabled	
FDD, COM, LPT Port	Enabled	
PCI PIRQ[A-D] #	Enabled	

Power Supply Type

Use this field to select the power supply type used in the system. The default setting is *ATX*.

ACPI Function

Enable this function to support ACPI (Advance Configuration and Power Interface).

Power Management

This field allows you to select the type of power saving management modes. There are four selections for Power Management.

Min. Power Saving	Minimum power management
Max. Power Saving	Maximum power management.
User Define	Each of the ranges is from 1 min. to 1hr. Except for HDD Power Down which ranges from 1 min. to 15 min.

Video Off Method

This field defines the Video Off features. There are three options.

V/H SYNC + Blank	Default setting, blank the screen and turn off vertical and horizontal scanning.
DPMS	Allows BIOS to control the video display.
Blank Screen	Writes blanks to the video buffer.

Video Off In Suspend

When enabled, the video is off in suspend mode. The default setting is *Yes*.

Suspend Type

The default setting for the Suspend Type field is *Stop Grant*.

Modem Use IRQ

This field sets the IRQ used by the Modem. By default, the setting is **3**.

Suspend Mode

When enabled, and after the set time of system inactivity, all devices except the CPU will be shut off.

HDD Power Down

When enabled, and after the set time of system inactivity, the hard disk drive will be powered down while all other devices remain active.

Soft-Off by PWRBTN

This field defines the power-off mode when using an ATX power supply. The *Instant Off* mode allows powering off immediately upon pressing the power button. In the *Delay 4 Sec* mode, the system powers off when the power button is pressed for more than four seconds or enters the suspend mode when pressed for less than 4 seconds.

CPU THRM-Throttling

When the system enters Doze mode, the CPU clock runs only part of the time. You may select the percent of time that the clock runs.

Wake up by PCI Card

By default, this field is disabled.

Power On by Ring

This field enables or disables the power on of the system through the modem connected to the serial port or LAN.

Resume by Alarm

This field enables or disables the resumption of the system operation. When enabled, the user is allowed to set the *Date* and *Time*.

Reload Global Timer Events

The HDD, FDD, COM, LPT Ports, and PCI PIRQ are I/O events that can prevent the system from entering a power saving mode or can awaken the system from such a mode. When an I/O device wants to gain the attention of the operating system, it signals this by causing an IRQ to occur. When the operating system is ready to respond to the request, it interrupts itself and performs the service.

PNP/PCI Configurations

This option configures the PCI bus system. All PCI bus systems on the system use INT#, thus all installed PCI cards must be set to this value.

Phoenix - AwardBIOS CMOS Setup Utility
PnP/PCI Configurations

PNP OS Installed	No	ITEM HELP
Reset Configuration Data	Disabled	Menu Level
Resources Controlled By IRQ Resources	Auto (ESCD) Press Enter	Select Yes if you are using a Plug and Play capable operating system Select No if you need the BIOS to configure non-boot devices
PCI/VGA Palette Snoop	Disabled	

PNP OS Installed

Enable the PNP OS Install option if it is supported by the operating system installed. The default value is *No*.

Reset Configuration Data

This field allows you to determine whether to reset the configuration data or not. The default value is *Disabled*.

Resources Controlled by

This PnP BIOS can configure all of the boot and compatible devices automatically with the use of a use a PnP operating system such as Windows 95.

PCI/VGA Palette Snoop

Some non-standard VGA display cards may not show colors properly. This field allows you to set whether or not MPEG ISA/VESA VGA cards can work with PCI/VGA. When this field is enabled, a PCI/VGA can work with an MPEG ISA/VESA VGA card. When this field is disabled, a PCI/VGA cannot work with an MPEG ISA/VESA card.

PC Health Status

This section shows the parameters in determining the PC Health Status. These parameters include temperatures, fan speeds and voltages.

Phoenix - AwardBIOS CMOS Setup Utility		ITEM HELP
PC Health Status		
Hardware Monitor	Enabled	
CPU Warning Temperature		
System Temp.		Menu Level >
CPU Temp.		
Chassis Temp.		
CPU FAN Speed (FAN1)		
System FAN Speed (FAN2)		
Chassis FAN Speed (FAN3)		
Vcore(V)		
VGMCH(V)		
+3.3V		
+5V		
+12V		
-12V		
VBAT		
5VSB(V)		
Shutdown Temperature	Disabled	
CPU Fan Failure Warning	Disabled	
Sys. Fan Failure Warning	Disabled	
Cha. Fan Failure Warning	Disabled	

Hardware Monitor

The Hardware Monitor can be enabled or disabled.

CPU Warning Temperature

This field allows the user to set the temperature so that when the temperature is reached, the system sounds a warning. This function can help prevent damage to the system that is caused by overheating.

Temperatures/Voltages

These fields are the parameters of the hardware monitoring function feature of the motherboard. The values are read-only values as monitored by the system and show the PC health status.

Shutdown Temperature

This field allows the user to set the temperature by which the system automatically shuts down once the threshold temperature is reached. This function can help prevent damage to the system that is caused by overheating.

CPU/System/Chassis Fan Failure Warning

When enabled, this field lets the system sounds an audible warning to the user that the CPU fan or chassis fan has malfunctioned.

Frequency/Voltage Control

This section shows the user how to configure the processor frequency.

Phoenix - AwardBIOS CMOS Setup Utility
Frequency/Voltage Control

Auto Detect PCI Clk	Disabled	ITEM HELP
Spread Spectrum Modulated	Disabled	Menu Level >

Auto Detect PCI Clk

This field enables or disables the auto detection of the PCI clock.

Spread Spectrum Modulated

This field sets the value of the spread spectrum. The default setting is *Disabled*. This field is for CE testing use only.

Load Fail-Safe Defaults

This option allows you to load the troubleshooting default values permanently stored in the BIOS ROM. These default settings are non-optimal and disable all high-performance features.

Load Optimized Defaults

This option allows you to load the default values to your system configuration. These default settings are optimal and enable all high performance features.

Set Supervisor Password

These two options set the system password. Supervisor Password sets a password that will be used to protect the system and Setup utility. User Password sets a password that will be used exclusively on the system. To specify a password, highlight the type you want and press <Enter>. The Enter Password: message prompts on the screen. Type the password, up to eight characters in length, and press <Enter>. The system confirms your password by asking you to type it again. After setting a password, the screen automatically returns to the main screen.

To disable a password, just press the <Enter> key when you are prompted to enter the password. A message will confirm the password to be disabled. Once the password is disabled, the system will boot and you can enter Setup freely.

Save & Exit Setup

This option allows you to determine whether or not to accept the modifications. If you type “Y”, you will quit the setup utility and save all changes into the CMOS memory. If you type “N”, you will return to Setup utility.

Exit Without Saving

Select this option to exit the Setup utility without saving the changes you have made in this session. Typing “Y” will quit the Setup utility without saving the modifications. Typing “N” will return you to Setup utility.

This page is intentionally left blank.

Drivers Installation

This section describes the installation procedures for software and drivers under the Windows 98SE, Windows ME, Windows 2000 and Windows XP. The software and drivers are included with the motherboard. If you find the items missing, please contact the vendor where you made the purchase. The contents of this section include the following:

Intel Chipset Software Intallation Utility	54
VGA Drivers Installation	55
AC97 Codec Audio Driver Installation.....	56
Intel PRO LAN Drivers Installation	57
Realtek Network Interface Controller Drivers.....	63

IMPORTANT NOTE:

After installing your Windows operating system (Windows 98SE/ME/2000/XP), you must install first the Intel Chipset Software Installation Utility before proceeding with the drivers installation.

Intel Chipset Software Intallation Utility

The Intel Chipset Drivers should be installed first before the software drivers to enable Plug & Play INF support for Intel chipset components. Follow the instructions below to complete the installation under Windows 98SE/ME/2000/XP.

1. Insert the CD that comes with the board. Click **Intel Chipsets** and then **Intel(R) 855GME Chipset Drivers**.
2. Click **Intel(R) Chipset Software Installation Utility**.

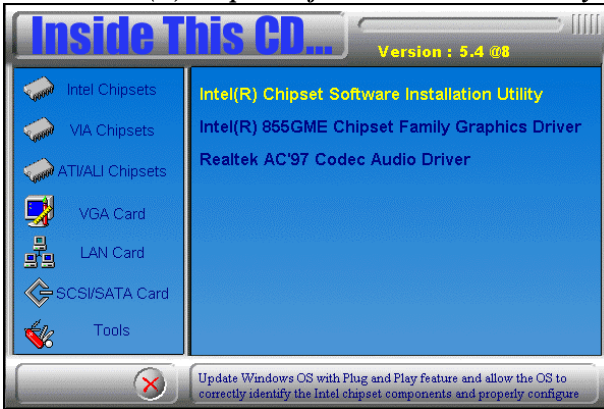

3. When the Welcome screen appears, click **Next** to continue.
4. On the next screen, click **Yes** to accept the software license agreement and proceed with the installation process.
5. On Readme Information screen, click **Next** to continue the installation.
6. The Setup process is now complete. Click **Finish** to restart the computer and for changes to take effect. When the computer has restarted, the system will be able to find some devices. Restart your computer when prompted.

VGA Drivers Installation

To install the VGA drivers, follow the steps below to proceed with the installation.

1. Insert the CD that comes with the motherboard. Click **Intel Chipsets** and then **Intel(R) 855GME Chipset Drivers**.
2. Click **Intel(R) 855GME Chipset Family Graphics Driver**.

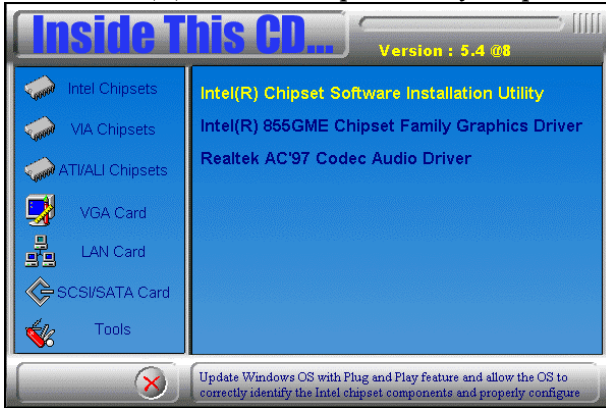

3. When the Welcome screen appears, click **Next** to continue.
4. Click **Yes** to agree with the license agreement and continue the installation.
5. Restart the computer as prompted and for changes to take effect.

AC97 Codec Audio Driver Installation

Follow the steps below to install the Realtek AC97 Codec Audio Drivers.

1. Insert the CD that comes with the motherboard. Click **Intel Chipsets** and then **Intel(R) 855GME Chipset Drivers**.
2. Click **Realtek AC'97 Codec Audio Driver**.

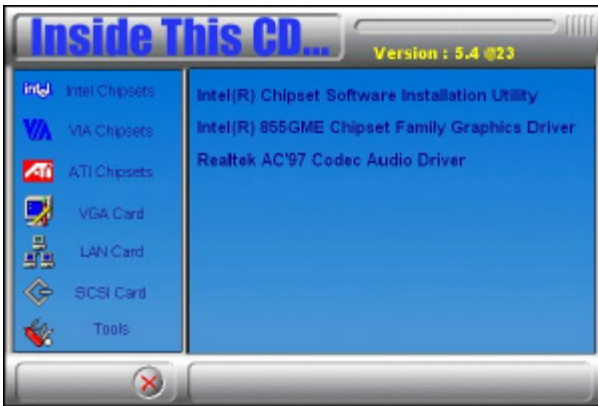

3. Click **Finish** to restart the computer and for changes to take effect. .

Intel PRO LAN Drivers Installation

Follow the steps below to complete the installation of the Intel PRO LAN drivers.

1. Insert the CD that comes with the motherboard. Click *LAN Card* and then *Intel(R) PRO LAN Drivers*.

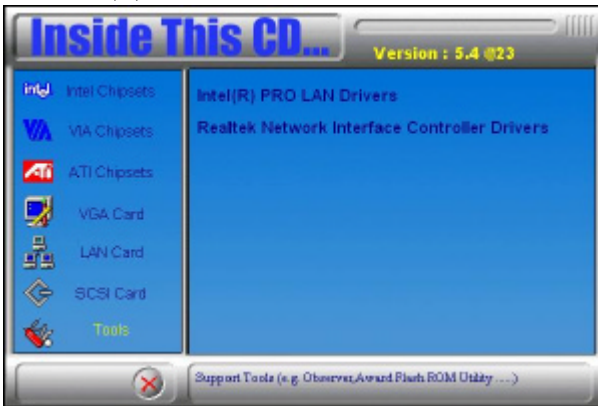

2. Click *Install Base Software* to continue.



4. When prompted, please to restart the computer for new settings to take effect.

Realtek Network Interface Controller Drivers Installation

Follow the steps below to install the Realtek Network Interface Controller Drivers.

1. Insert the CD that comes with the motherboard and on the initial screen click LAN Card → Realtek Network Interface Controller Drivers
2. When the welcome screen appears, click Next to continue.
3. On the next screen, click Finish to restart the computer.

Appendix

A. I/O Port Address Map

Each peripheral device in the system is assigned a set of I/O port addresses which also becomes the identity of the device. The following table lists the I/O port addresses used.

Address	Device Description
000h - 01Fh	DMA Controller #1
020h - 03Fh	Interrupt Controller #1
040h - 05Fh	Timer
060h - 06Fh	Keyboard Controller
070h - 07Fh	Real Time Clock, NMI
080h - 09Fh	DMA Page Register
0A0h - 0BFh	Interrupt Controller #2
0C0h - 0DFh	DMA Controller #2
0F0h	Clear Math Coprocessor Busy Signal
0F1h	Reset Math Coprocessor
1F0h - 1F7h	IDE Interface
278h - 27Fh	Parallel Port #2(LPT2)
2F8h - 2FFh	Serial Port #2(COM2)
2B0h - 2DFh	Graphics adapter Controller
378h - 3FFh	Parallel Port #1(LPT1)
360h - 36Fh	Network Ports
3B0h - 3BFh	Monochrome & Printer adapter
3C0h - 3CFh	EGA adapter
3D0h - 3DFh	CGA adapter
3F0h - 3F7h	Floppy Disk Controller
3F8h - 3FFh	Serial Port #1(COM1)

B. Interrupt Request Lines (IRQ)

Peripheral devices use interrupt request lines to notify CPU for the service required. The following table shows the IRQ used by the devices on board.

Level	Function
IRQ0	System Timer Output
IRQ1	Keyboard
IRQ2	Interrupt Cascade
IRQ3	Serial Port #2
IRQ4	Serial Port #1
IRQ5	Reserved
IRQ6	Floppy Disk Controller
IRQ7	Parallel Port #1
IRQ8	Real Time Clock
IRQ9	Reserved
IRQ10	Reserved
IRQ11	Reserved
IRQ12	PS/2 Mouse
IRQ13	80287
IRQ14	Primary IDE
IRQ15	Secondary IDE