

IB883

Intel Atom 945GSE
3.5-inch Embedded Board

USER'S MANUAL

Version 1.0

Acknowledgments

Award is a registered trademark of Award Software International, Inc.

PS/2 is a trademark of International Business Machines Corporation.

Intel® and **Atom™** are registered trademarks of Intel Corporation.

Microsoft Windows is a registered trademark of Microsoft Corporation.

Winbond is a registered trademark of Winbond Electronics Corporation.

All other product names or trademarks are properties of their respective owners.

Table of Contents

Introduction	1
Product Description.....	1
Checklist.....	2
IB883 Specifications	3
Board Dimensions	4
Installations	5
Installing the Memory	6
Setting the Jumpers	7
Connectors on IB883.....	11
BIOS Setup.....	21
Drivers Installation	45
Appendix	54
A. I/O Port Address Map.....	54
B. Interrupt Request Lines (IRQ).....	55
C. Watchdog Timer Configuration.....	56

This page is intentionally left blank.

Introduction

Product Description

The IB883 is a small footprint single board computer that is configured with the Intel Atom processor N270 at 1.6GHz, FSB533 and the Mobile Intel 945GSE Express Chipset with the ICH7M.

This 3.5-inch disk-size embedded board provides greater flexibility for developers of embedded computing solutions. It is ideally suited for rugged and compact designs as in internet devices and applications in automation, industrial control, data acquisition, thin client and other embedded PC applications.

IB883 features the Intel's Graphics Media Accelerator 950 core, making it compatible with Windows Vista Premium, and Chrontel CH7307 DVI accelerator to support display interfaces including VGA CRT, single channel LVDS and a DVI port. One DDR2 SO-DIMM on board implements up to 1GB of system memory. Dual Gigabit LAN is also available.

Advanced connectivity and expansion interfaces are provided by one IDE, one high-speed SATA-II, two serial ports, four USB 2.0, a CF socket, along with a PCI Express x1 interface. Dimensions of the board are 102x147mm.

Checklist

Your IB883 package should include the items listed below.

- The IB883 embedded board
- This User's Manual
- 1 CD containing chipset drivers and flash memory utility
- Cables are (shown below) optional.

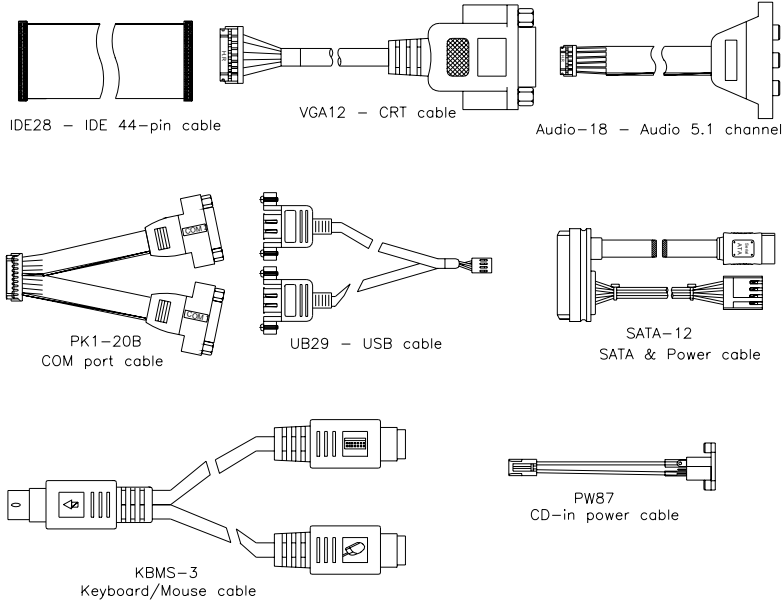

IB883 Specifications

Intel Atom 3.5-inch Disk Size SBC with Intel 945GSE Chipset

Features

- Supports Intel® Atom processors
1.6GHz speed, 533MHz FSB
- DDR2 SODIMM x1, Max. 1GB memory
- Intel 945GSE VGA for CRT / LVDS
- Onboard Chrontel CH7307 for DVI
- Dual Intel PCI-E Gigabit Ethernet
- Watchdog timer, Digital I/O
- 1x SATA, 1x IDE, 4x USB 2.0, 2x COM, CF Socket, LPC Connector

System

CPU	Intel N270 Atom processor, 1.6GHz
System Memory	DDR SODIMM x1, Max. 1GB, single channel
System Chipset	Intel 945GSE (533MHz FSB) + ICH7M
BIOS	Award
Watchdog Timer	256 levels
SSD	Type II CF Socket
H/W Monitor	Yes
Expansion Slot	1 PCI-E (x1), LPC connector

Graphics

VGA Controller	Intel Graphics Media Accelerator (GMA) 950, supports CRT and single channel LVDS
VGA Memory	Intel Dynamic Video Memory Technology (DVM 3.0) Maximum shared memory: 224MB
DVI Interface	Chrontel CH7307, DVI port on board

Ethernet

Controller	Dual Intel PCI-E Gigabit LAN
Connector	Pin header for RJ-45

Multi I/O

Chipset	ICH7M, Winbond W83627EHF, 1x KB, 1x Mouse 1x RS232, 1x RS-232/422/485, 1x SATAII, 1x IDE, 1x CF
USB	2 ports on board Pin header for 2 ports (USB 2.0)
Audio	Built-in Intel High Definition Audio + ALC662 Codec for 6 channels
Others	Digital I/O, 2-pin DC power connector
Dimensions	102mm x 147mm (4" x 5.8")

Board Dimensions

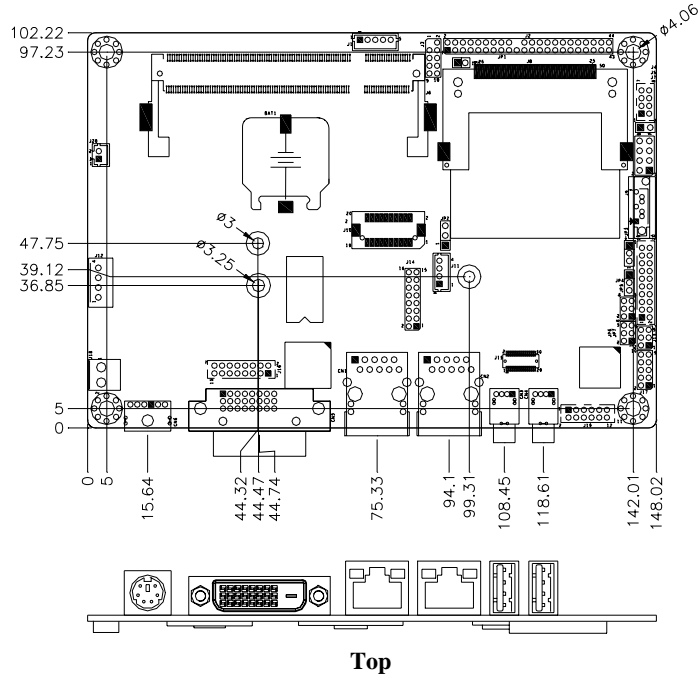

Top

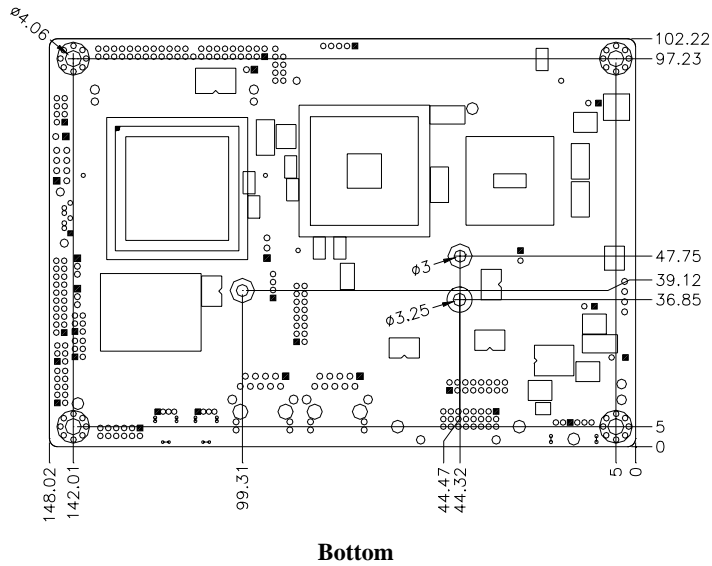

Bottom

Installations

This section provides information on how to use the jumpers and connectors on the IB883 in order to set up a workable system. The topics covered are:

Installing the Memory 6
Setting the Jumpers..... 7
Connectors on IB883 11

Installing the Memory

The IB883 board supports one DDR2 memory socket that can support up to 1GB memory, DDR2 400/533 (w/o ECC function).

Installing and Removing Memory Modules

To install the DDR2 modules, locate the memory slot on the board and perform the following steps:

1. Hold the DDR2 module so that the key of the DDR2 module aligns with that on the memory slot. Insert the module into the socket at a slight angle (approximately 30 degrees). Note that the socket and module are both keyed, which means that the module can be installed only in one direction.
2. To seat the memory module into the socket, apply firm and even pressure to each end of the module until you feel it slip down into the socket.
3. With the module properly seated in the socket, rotate the module downward. Continue pressing downward until the clips at each end lock into position.
4. To remove the DDR2 module, press the clips with both hands.

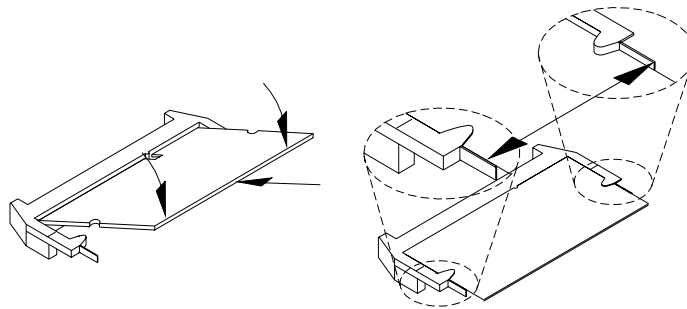

Setting the Jumpers

Jumpers are used on IB883 to select various settings and features according to your needs and applications. Contact your supplier if you have doubts about the best configuration for your needs. The following lists the connectors on IB883 and their respective functions.

Jumper Locations on IB883.....	8
JP5, JP6, JP7: RS232/422/485 (COM2) Selection	9
JP3: Clear CMOS Setting	9
JP4: ATX or AT Power Selection	9
JP1: CompactFlash Slave/Master Selection	10
JP2: LCD Panel Power Selection	10

Jumper Locations on IB883

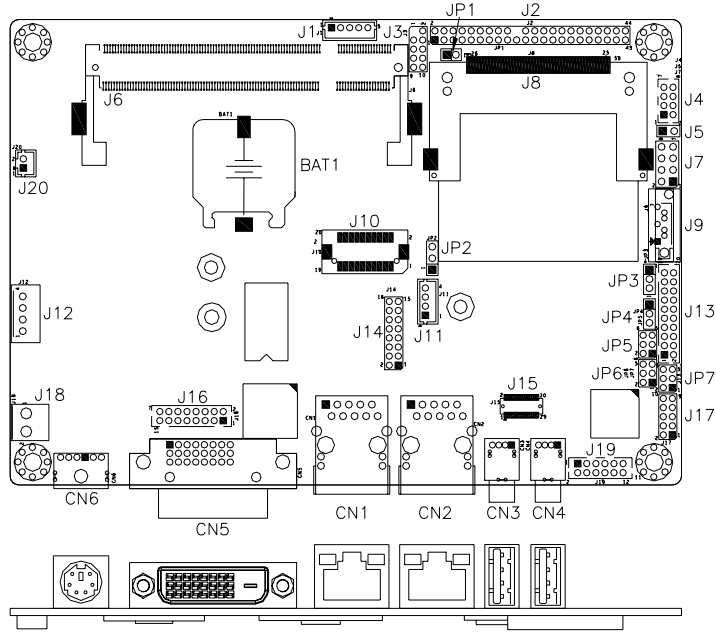

Jumpers on IB883	Page
JP5, JP6, JP7: RS232/422/485 (COM2) Selection	9
JP3: Clear CMOS Setting	9
JP4: ATX or AT Power Selection.....	9
JP1: CompactFlash Slave/Master Selection.....	10
JP2: LCD Panel Power Selection.....	10

JP5, JP6, JP7: RS232/422/485 (COM2) Selection

COM1 is fixed for RS-232 use only. COM2 is selectable for RS232, RS-422 and RS-485. The following describes the settings for COM2.

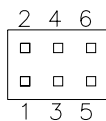

COM2 Function	RS-232	RS-422	RS-485
Jumper Setting (pin closed)	JP7: 1-2	JP7: 3-4	JP7: 5-6
	JP6: 3-5 & 4-6	JP6: 1-3 & 2-4	JP6: 1-3 & 2-4
	JP5: 3-5 & 4-6	JP5: 1-3 & 2-4	JP5: 1-3 & 2-4

COM2 is jumper selectable for RS-232, RS-422 and RS-485.

Pin #	Signal Name		
	RS-232	RS-422	RS-485
11	DCD	TX-	DATA-
13	RX	TX+	DATA+
15	TX	RX+	NC
17	DTR	RX-	NC
19	Ground	Ground	Ground
12	DSR	NC	NC
14	RTS	NC	NC
16	CTS	NC	NC
18	RI	NC	NC
20	NC	NC	NC



JP3: Clear CMOS Setting

JP3	Setting
 1 2 3	Normal
 1 2 3	Clear CMOS



JP4: ATX or AT Power Selection

JP4	ATX Power
 1 2 3	ATX
 1 2 3	AT

JP1: CompactFlash Slave/Master Selection

JP1	CF Setting
 Short	Master
 Open	Slave

JP2: LCD Panel Power Selection

JP2	LCD Panel Power
 1 2 3	3.3V
 1 2 3	5V

Connectors on IB883

Connector Locations on IB883.....	12
CN3, CN4: USB0/1 Ports.....	13
CN1, CN2: GbE RJ45 Ports.....	13
CN5: DVI-D Connector.....	13
CN6: PS/2 Keyboard/Mouse Connector.....	13
J18: DC-IN 12V Power Connector.....	13
J1: Smart Battery Interface Connector.....	14
J2: IDE Connector.....	14
J3: SPI Flash Connector (factory use only).....	14
J4: USB2/USB3 Connector (DF11 Connector).....	15
J5: Speaker.....	15
J7: System Function Connector.....	15
J8: CF Socket.....	16
J9: SATA Connector.....	16
J10: LVDS Connector (DF13 Connector).....	16
J11: LCD Backlight Connector (DC type).....	16
J12: HDD Power Connector.....	16
J13: COM1, COM2 Serial Port (DF11 Connector).....	17
J14: For LPC I/F Adaptor Card.....	17
ID394 with Fintek F81216, 2 or 4 Serial Ports.....	17
ID395 Winbond WPCT200 x1 for TPM1.2.....	17
ID395 Winbond WPCT200 for TPM1.2.....	17
ID394 LPC Serial Ports Adaptor Card.....	18
J16: VGA Connector (DF11 Connector).....	19
J17: Digital I/O.....	19
J19: Audio Connector (DF11 Connector).....	19

Connector Locations on IB883

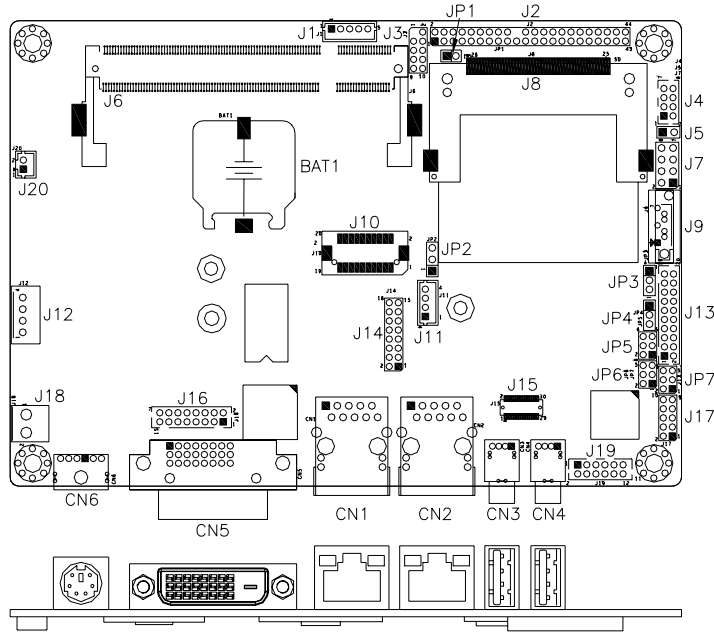

Connector Locations on IB883

CN3, CN4: USB0/1 Ports.....	13
CN1, CN2: GbE RJ45 Ports.....	13
CN5: DVI-D Connector	13
CN6: PS/2 Keyboard/Mouse Connector	13
J18: DC-IN 12V Power Connector	13
J1: Smart Battery Interface Connector	14
J2: IDE Connector	14
J3: SPI Flash Connector (factory use only).....	14
J4: USB2/USB3 Connector (DF11 Connector)	15
J5: Speaker.....	15
J7: System Function Connector.....	15
J8: CF Socket.....	16
J9: SATA Connector	16
J10: LVDS Connector (DF13 Connector)	16
J11: LCD Backlight Connector (DC type).....	16
J12: HDD Power Connector.....	16
J13: COM1, COM2 Serial Port (DF11 Connector)	17
J14: For LPC I/F Adaptor Card.....	17
J16: VGA Connector (DF11 Connector)	19
J17: Digital I/O	19
J19: Audio Connector (DF11 Connector).....	19

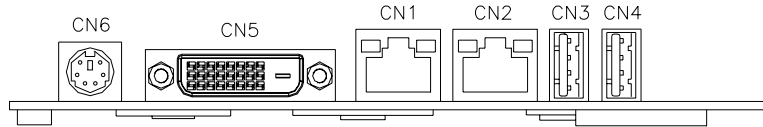

CN3, CN4: USB0/1 Ports

CN1, CN2: GbE RJ45 Ports

CN5: DVI-D Connector

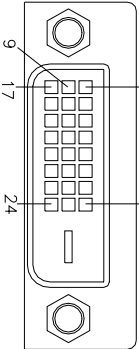

Signal Name	Pin #	Pin #	Signal Name
DATA 2-	1	16	HOT POWER
DATA 2+	2	17	DATA 0-
Shield 2/4	3	18	DATA 0+
DATA 4-	4	19	SHIELD 0/5
DATA 4+	5	20	DATA 5-
DDC CLOCK	6	21	DATA 5+
DDC DATA	7	22	SHIELD CLK
VSYNC	8	23	CLOCK -
DATA 1-	9	24	CLOCK +
DATA 1+	10		
SHIELD 1/3	11		
DATA 3-	12		
DATA 3+	13		
DDC POWER	14		
A GROUND 1	15		

CN6: PS/2 Keyboard/Mouse Connector



Pin #	Signal Name
1	Keyboard data
2	Mouse data
3	GND
4	5V
5	Keyboard clock
6	Mouse clock

J18: DC-IN 12V Power Connector



Pin #	Signal Name
1	DC in (12V only)
2	Ground

J1: Smart Battery Interface Connector

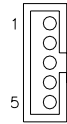

Pin #	Signal Name
1	RST
2	EXTSMI
3	Ground
4	DATA
5	CLK

J2: IDE Connector

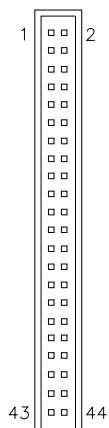

Signal Name	Pin #	Pin #	Signal Name
Reset IDE	1	2	Ground
Host data 7	3	4	Host data 8
Host data 6	5	6	Host data 9
Host data 5	7	8	Host data 10
Host data 4	9	10	Host data 11
Host data 3	11	12	Host data 12
Host data 2	13	14	Host data 13
Host data 1	15	16	Host data 14
Host data 0	17	18	Host data 15
Ground	19	20	Key
DRQ0	21	22	Ground
Host IOW	23	24	Ground
Host IOR	25	26	Ground
IOCHRDY	27	28	Host ALE
DACK0	29	30	Ground
IRQ14	31	32	No connect
Address 1	33	34	No connect
Address 0	35	36	Address 2
Chip select 0	37	38	Chip select 1
Activity	39	40	Ground
Vcc	41	42	Vcc
Ground	43	44	N.C.

J3: SPI Flash Connector (factory use only)

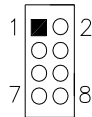
J4: USB2/USB3 Connector (DF11 Connector)

Signal Name	Pin	Pin	Signal Name
Vcc	1	2	Ground
D0-	3	4	D1+
D0+	5	6	D1-
Ground	7	8	Vcc

Note: This USB connector is compatible with USB 2.0 devices only.

J5: Speaker

Pin #	Signal Name
1	+5V
2	Speaker

J7: System Function Connector**ATX Power ON Switch: Pins 1 and 2**

This 2-pin connector is an “ATX Power Supply On/Off Switch” on the system that connects to the power switch on the case. When pressed, the power switch will force the system to power on. When pressed again, it will force the system to power off.

Power LED: Pins 3 and 4

Pin #	Signal Name
3	Vcc
4	Ground

Hard Disk Drive LED Connector: Pins 5 and 6

This connector connects to the hard drive activity LED on control panel. This LED will flash when the HDD is being accessed.

Pin #	Signal Name
6	HDD Active
5	Vcc

Reset Switch: Pins 7 and 8

The reset switch allows the user to reset the system without turning the main power switch off and then on again.

J8: CF Socket

J9: SATA Connector

J10: LVDS Connector (DF13 Connector)

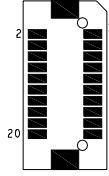

Signal Name	Pin #	Pin #	Signal Name
TX0-	2	1	TX0+
Ground	4	3	Ground
TX1-	6	5	TX1+
*5V/3.3V	8	7	Ground
NC	10	9	NC
TX2-	12	11	TX2+
Ground	14	13	Ground
TXC-	16	15	TXC+
*5V/3.3V	18	17	ENABKL
+12V	20	19	+12V

**JP2 can be used to set 3.3V or 5V.*

J11: LCD Backlight Connector (DC type)



Pin #	Signal Name
1	+12V
2	Backlight Enable
3	*Backlight Adj (DC type)
4	Ground

** LCD backlight can be controlled by the OS.*

J12: HDD Power Connector



Pin #	Signal Name
1	+5V
2	Ground
3	Ground
4	+12V

J13: COM1, COM2 Serial Port (DF11 Connector)

Signal Name	Pin #	Pin #	Signal Name
DSR1 Data set ready	2	1	DCD1 Data carrier detect
RTS1 Request to send	4	3	RXD1 Receive data
CTS1 Clear to send	6	5	TXD1 Transmit data
RI1 Ringing indicator	8	7	DTR1 Data terminal ready
Not used	10	9	Ground
DSR2	12	11	DCD2
RTS2	14	13	RXD2
CTS2	16	15	TXD2
RI2	18	17	DTR2
Not used	20	19	Ground

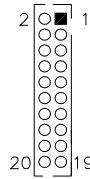

J14: For LPC I/F Adaptor Card

ID394 with Fintek F81216, 2 or 4 Serial Ports

ID395 Winbond WPCT200 x1 for TPM1.2

ID395 Winbond WPCT200 for TPM1.2

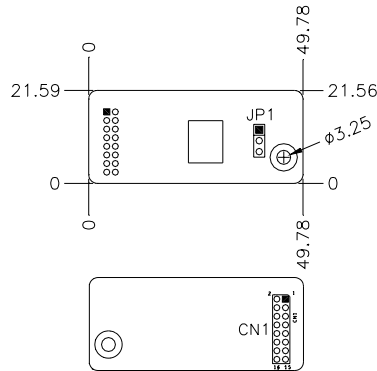

CN1: LPC I/F connectors

Package list

Nylon Nut x1; Screw x2; Washer x2

ID394 LPC Serial Ports Adaptor Card

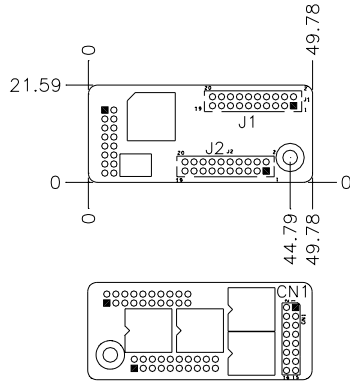

J1 J2: COM3/4/5/6 Serial Ports
 J1 - COM3/4 pin-header connector.
 Pin1~Pin10 COM3
 Pin11~Pin20 COM4
 J2 - COM5/6 pin-header connector.
 Pin1~Pin10 COM5
 Pin11~Pin20 COM6

Signal Name	Pin #	Pin #	Signal Name
DCD, Data carrier detect	1	2	DSR, Data set ready
RXD, Receive data	3	4	RTS, Request to send
TXD, Transmit data	5	6	CTS, Clear to send
DTR, Data terminal ready	7	8	RI, Ring indicator
GND, ground	9	10	Not Used
DCD, Data carrier detect	11	12	DSR, Data set ready
RXD, Receive data	13	14	RTS, Request to send
TXD, Transmit data	15	16	CTS, Clear to send
DTR, Data terminal ready	17	18	RI, Ring indicator
GND, ground	19	20	Not Used

CN1: LPC I/F connectors
 Package list:
 COM port cable (PK1-20B) x2; Nylon Nut x1;
 Screw x2; Washer x2

J16: VGA Connector (DF11 Connector)

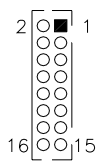

Signal Name	Pin	Pin	Signal Name
+5V	2	1	Red
Ground	4	3	Green
N.C	6	5	Blue
DDCDATA	8	7	N.C
H_SYNC	10	9	GND
V_SYNC	12	11	GND
DDCCLK	14	13	GND
N.C.	16	15	GND

J17: Digital I/O

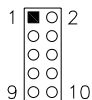

Signal Name	Pin	Pin	Signal Name
GND	1	2	VCC
OUT3	3	4	OUT1
OUT2	5	6	OUT0
IN3	7	8	IN1
IN2	9	10	IN0

J19: Audio Connector (DF11 Connector)

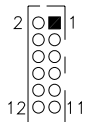

Signal Name	Pin #	Pin #	Signal Name
LINEOUT_R	2	1	LINEOUT_L
Ground	4	3	JD_FRONT
LINEIN_R	6	5	LINEIN
Ground	8	7	JD_LINEIN
MIC-In	10	9	MIC_L
Ground	12	11	JD_MIC1

This page is intentionally left blank.

BIOS Setup

This chapter describes the different settings available in the Award BIOS that comes with the board. The topics covered in this chapter are as follows:

BIOS Introduction	22
BIOS Setup.....	22
Standard CMOS Setup	24
Advanced BIOS Features	27
Advanced Chipset Features	30
Integrated Peripherals	33
Power Management Setup.....	37
PNP/PCI Configurations	40
PC Health Status.....	41
Frequency/Voltage Control	42
Load Fail-Safe Defaults.....	43
Load Optimized Defaults	43
Set Supervisor/User Password.....	43
Save & Exit Setup	43
Exit Without Saving	43

BIOS Introduction

The Award BIOS (Basic Input/Output System) installed in your computer system's ROM supports Intel processors. The BIOS provides critical low-level support for a standard device such as disk drives, serial ports and parallel ports. It also adds virus and password protection as well as special support for detailed fine-tuning of the chipset controlling the entire system.

BIOS Setup

The Award BIOS provides a Setup utility program for specifying the system configurations and settings. The BIOS ROM of the system stores the Setup utility. When you turn on the computer, the Award BIOS is immediately activated. Pressing the key immediately allows you to enter the Setup utility. If you are a little bit late pressing the key, POST (Power On Self Test) will continue with its test routines, thus preventing you from invoking the Setup. If you still wish to enter Setup, restart the system by pressing the "Reset" button or simultaneously pressing the <Ctrl>, <Alt> and <Delete> keys. You can also restart by turning the system Off and back On again. The following message will appear on the screen:

Press to Enter Setup

In general, you press the arrow keys to highlight items, <Enter> to select, the <PgUp> and <PgDn> keys to change entries, <F1> for help and <Esc> to quit.

When you enter the Setup utility, the Main Menu screen will appear on the screen. The Main Menu allows you to select from various setup functions and exit choices.

Phoenix - AwardBIOS CMOS Setup Utility

Standard CMOS Features	Frequency/Voltage Control
Advanced BIOS Features	Load Fail-Safe Defaults
Advanced Chipset Features	Load Optimized Defaults
Integrated Peripherals	Set Supervisor Password
Power Management Setup	Set User Password
PnP/PCI Configurations	Save & Exit Setup
PC Health Status	Exit Without Saving
ESC : Quit	↑ ↓ → ← : Select Item
F10 : Save & Exit Setup	
Time, Date, Hard Disk Type...	

The section below the setup items of the Main Menu displays the control keys for this menu. At the bottom of the Main Menu just below the control keys section, there is another section, which displays information on the currently highlighted item in the list.

Note: *If the system cannot boot after making and saving system changes with Setup, the Award BIOS supports an override to the CMOS settings that resets your system to its default.*

Warning: *It is strongly recommended that you avoid making any changes to the chipset defaults. These defaults have been carefully chosen by both Award and your system manufacturer to provide the absolute maximum performance and reliability. Changing the defaults could cause the system to become unstable and crash in some cases.*

Standard CMOS Setup

“Standard CMOS Setup” choice allows you to record some basic hardware configurations in your computer system and set the system clock and error handling. If the board is already installed in a working system, you will not need to select this option. You will need to run the Standard CMOS option, however, if you change your system hardware configurations, the onboard battery fails, or the configuration stored in the CMOS memory was lost or damaged.

Phoenix - AwardBIOS CMOS Setup Utility
Standard CMOS Features

		Item Help
Date (mm:dd:yy)	Wed, Apr 28, 2004	Menu Level >
Time (hh:mm:ss)	00 : 00 : 00	
IDE Channel 0 Master	None	Change the day, month, Year and century
IDE Channel 0 Slave	None	
IDE Channel 1 Master	None	
IDE Channel 1 Slave	None	
Video	EGA/VGA	
Halt On	All, But Keyboard	
Base Memory	640K	
Extended Memory	129024K	
Total Memory	130048K	

At the bottom of the menu are the control keys for use on this menu. If you need any help in each item field, you can press the <F1> key. It will display the relevant information to help you. The memory display at the lower right-hand side of the menu is read-only. It will adjust automatically according to the memory changed. The following describes each item of this menu.

Date

The date format is:

Day : Sun to Sat
Month : 1 to 12
Date : 1 to 31
Year : 1999 to 2099

To set the date, highlight the “Date” field and use the PageUp/PageDown or +/- keys to set the current time.

Time

The time format is: **Hour : 00 to 23**
Minute : 00 to 59
Second : 00 to 59

To set the time, highlight the “Time” field and use the <PgUp>/<PgDn> or +/- keys to set the current time.

IDE Channel Master/Slave

The onboard PCI IDE connector provides Primary and Secondary channels for connecting up to two IDE hard disks or other IDE devices.

Press <Enter> to configure the hard disk. The selections include Auto, Manual, and None. Select ‘Manual’ to define the drive information manually. You will be asked to enter the following items.

CYLS : Number of cylinders
HEAD : Number of read/write heads
PRECOMP : Write precompensation
LANDING ZONE : Landing zone
SECTOR : Number of sectors

The Access Mode selections are as follows:

CHS (HD < 528MB)
LBA (HD > 528MB and supports
 Logical Block Addressing)
Large (for MS-DOS only)
Auto

Remarks: The main board supports two serial ATA ports and are represented in this setting as IDE Channel 0.

Video

This field selects the type of video display card installed in your system.

You can choose the following video display cards:

EGA/VGA	For EGA, VGA, SEGA, SVGA or PGA monitor adapters. (default)
CGA 40	Power up in 40 column mode.
CGA 80	Power up in 80 column mode.
MONO	For Hercules or MDA adapters.

Halt On

This field determines whether or not the system will halt if an error is detected during power up.

No errors	The system boot will not be halted for any error that may be detected.
All errors	Whenever the BIOS detects a non-fatal error, the system will stop and you will be prompted.
All, But Keyboard	The system boot will not be halted for a keyboard error; it will stop for all other errors
All, But Diskette	The system boot will not be halted for a disk error; it will stop for all other errors.
All, But Disk/Key	The system boot will not be halted for a keyboard or disk error; it will stop for all others.

Advanced BIOS Features

This section allows you to configure and improve your system and allows you to set up some system features according to your preference.

Phoenix - AwardBIOS CMOS Setup Utility
Advanced BIOS Features

CPU Feature	Press Enter	ITEM HELP
Hard Disk Boot Priority	Press Enter	
Virus Warning	Disabled	Menu Level >
CPU L1 and L2 Cache	Enabled	
CPU L3	Enabled	
Hyper-Threading Technology	Enabled	
Quick Power On Self Test	Enabled	
First Boot Device	Hard Disk	
Second Boot Device	CDROM	
Third Boot Device	USB-CDROM	
Boot Other Device	Enabled	
Boot Up NumLock Status	On	
Gate A20 Option	Fast	
Typematic Rate Setting	Disabled	
Typematic Rate (Chars/Sec)	6	
Typematic Delay (Msec)	250	
Security Option	Setup	
APIC Mode	Enabled	
MPS Version Control for OS	1.4	
OS Select For DRAM>64MB	Non-OS2	
Small Logo (EPA) Show	Disabled	

CPU Feature

Press Enter to configure the settings relevant to CPU Feature.

Hard Disk Boot Priority

With the field, there is the option to choose, aside from the hard disks connected, "Bootable add-in Cards" which refers to other external devices.

Virus Warning

If this option is enabled, an alarm message will be displayed when trying to write on the boot sector or on the partition table on the disk, which is typical of the virus.

CPU L1/L2/L3 Cache

Cache memory is additional memory that is faster than conventional DRAM (system memory). CPUs from 486-type on up contain internal cache memory, and most, but not all, modern PCs have additional (external) cache memory. When the CPU requests data, the system transfers the requested data from the main DRAM into cache memory, for even faster access by the CPU. These allow you to enable (speed up memory access) or disable the cache function.

Hyper-Threading Technology

By default, this field is enabled.

Quick Power On Self Test

When enabled, this field speeds up the Power On Self Test (POST) after the system is turned on. If it is set to *Enabled*, BIOS will skip some items.

First/Second/Third Boot Device

These fields determine the drive that the system searches first for an operating system. The options available include *Floppy*, *LS120*, *Hard Disk*, *CDROM*, *ZIP100*, *USB-Floppy*, *USB-ZIP*, *USB-CDROM*, *LAN* and *Disable*.

Boot Other Device

These fields allow the system to search for an OS from other devices other than the ones selected in the First/Second/Third Boot Device.

Boot Up NumLock Status

This allows you to activate the NumLock function after you power up the system.

Gate A20 Option

This field allows you to select how Gate A20 is worked. Gate A20 is a device used to address memory above 1 MB.

Typematic Rate Setting

When disabled, continually holding down a key on your keyboard will generate only one instance. When enabled, you can set the two typematic controls listed next. By default, this field is set to *Disabled*.

Typematic Rate (Chars/Sec)

When the typematic rate is enabled, the system registers repeated keystrokes speeds. Settings are from 6 to 30 characters per second.

Typematic Delay (Msec)

When the typematic rate is enabled, this item allows you to set the time interval for displaying the first and second characters. By default, this item is set to *250msec*.

Security Option

This field allows you to limit access to the System and Setup. The default value is *Setup*. When you select *System*, the system prompts for the User Password every time you boot up. When you select *Setup*, the system always boots up and prompts for the Supervisor Password only when the Setup utility is called up.

APIC Mode

APIC stands for Advanced Programmable Interrupt Controller. The default setting is *Enabled*.

MPS Version Control for OS

This option specifies the MPS (Multiprocessor Specification) version for your operating system. MPS version 1.4 added extended configuration tables to improve support for multiple PCI bus configurations and improve future expandability. The default setting is *1.4*.

OS Select for DRAM > 64MB

This option allows the system to access greater than 64MB of DRAM memory when used with OS/2 that depends on certain BIOS calls to access memory. The default setting is *Non-OS/2*.

Small Logo (EPA) Show

The EPA logo appears at the right side of the monitor screen when the system is boot up.

Advanced Chipset Features

This Setup menu controls the configuration of the chipset.

Phoenix - AwardBIOS CMOS Setup Utility
Advanced Chipset Features

		ITEM HELP
DRAM Timing Selectable	By SPD	Menu Level >
CAS Latency Time	Auto	
DRAM RAS# to CAS# Delay	Auto	
DRAM RAS# Precharge	Auto	
Precharge delay (tRAS)	Auto	
System Memory Frequency	Auto	
SLP_S4# Assertion Width	1 to 2 Sec	
System BIOS Cacheable	Enabled	
Video BIOS Cacheable	Disabled	
Memory Hole at 15M-16M	Disabled	
PCI Express Root Port Func	Press Enter	
** On-Chip VGA Setting **		
PEG/On Chip VGA Control	Auto	
On-Chip Frame Buffer Size	8MB	
DVMT Mode	DVMT	
DVMT/FIXED memory Size	128MB	
SDVO Device Setting	DVI	
Boot Display	CRT+DVI	
Panel Scaling	Auto	
Panel Number	1024x768 18 bit SC	

DRAM Timing Selectable

This option refers to the method by which the DRAM timing is selected. The default is **By SPD**.

CAS Latency Time

You can configure CAS latency time in HCLKs as 2 or 2.5 or 3. The system board designer should set the values in this field, depending on the DRAM installed. Do not change the values in this field unless you change specifications of the installed DRAM or the installed CPU.

DRAM RAS# to CAS# Delay

This option allows you to insert a delay between the RAS (Row Address Strobe) and CAS (Column Address Strobe) signals. This delay occurs when the SDRAM is written to, read from or refreshed. Reducing the delay improves the performance of the SDRAM.

DRAM RAS# Precharge

This option sets the number of cycles required for the RAS to accumulate its charge before the SDRAM refreshes. The default setting for the Active to Precharge Delay is *Auto*.

Precharge Delay (tRAS)

The default setting for the Precharge Delay is *Auto*.

System Memory Frequency

The default setting is *Auto*.

SLP_S4# Assertion Width

The default setting is *1 to 2 Sec*.

System BIOS Cacheable

The setting of *Enabled* allows caching of the system BIOS ROM at F000h-FFFFh, resulting in better system performance. However, if any program writes to this memory area, a system error may result.

Video BIOS Cacheable

The Setting *Enabled* allows caching of the video BIOS ROM at C0000h-F7FFFh, resulting in better video performance. However, if any program writes to this memory area, a system error may result.

Memory Hole At 15M-16M

In order to improve performance, certain space in memory can be reserved for ISA cards. This memory must be mapped into the memory space below 16 MB. The choices are *Enabled* and *Disabled*.

On-Chip VGA Setting

The fields under the On-Chip VGA Setting and their default settings are:

- PEG/On Chip VGA Control: Auto
- On-Chip Frame Buffer Size: 8MB
- DVMT Mode: DVMT
- DVMT/Fixed Memory Size: 128MB
- SDVO Device Setting: DVI
- Boot Display: CRT+DVI
- Panel Scaling: Auto
- Panel Number: 1024x768 18 bit SC

Panel Scaling

The default setting is *Auto*. The options available include *On* and *Off*.

Panel Number

These fields allow you to select the LCD Panel type. The default values for these ports are:

640x480	18bit SC
800x480	18bit SC
800x600	18bit SC
1024x768	18bit SC
1280x768	18bit SC
1280x800	18bit SC
1366x768	18bit SC

Integrated Peripherals

This section sets configurations for your hard disk and other integrated peripherals. The first screen shows three main items for user to select. Once an item selected, a submenu appears. Details follow.

Phoenix - AwardBIOS CMOS Setup Utility
Integrated Peripherals

OnChip IDE Device	Press Enter	ITEM HELP
Onboard Device	Press Enter	Menu Level >
SuperIO Device	Press Enter	

Phoenix - AwardBIOS CMOS Setup Utility
OnChip IDE Device

IDE HDD Block Mode	Enabled	ITEM HELP
IDE DMA Transfer Access	Enabled	
On-chip Primary PCI IDE	Auto	Menu Level >
IDE Primary Master PIO	Auto	
IDE Primary Slave PIO	Auto	
IDE Primary Master UDMA	Auto	
IDE Primary Slave UDMA	Auto	
On-Chip Secondary PCI IDE	Enabled	
IDE Secondary Master PIO	Auto	
IDE Secondary Slave PIO	Auto	
IDE Secondary Master UDMA	Auto	
IDE Secondary Slave UDMA	Auto	
*** On-Chip Serial ATA Setting ***		
SATA Mode	IDE	
On-Chip Serial ATA	Auto	
PATA IDE Mode	Secondary	
SATA port	P0, P2 is Primary	

Phoenix - AwardBIOS CMOS Setup Utility
Onboard Device

USB Controller	Enabled	ITEM HELP
USB 2.0 Controller	Enabled	Menu Level >
USB Keyboard Support	Enabled	
AC97 Audio Select	Auto	

		ITEM HELP
POWER ON Function	BUTTON ONLY	
KB Power ON Password	Enter	
Hot Key power ON	Ctrl-F1	
Onboard FDC Controller	Enabled	
Onboard Serial Port 1	3F8/IRQ4	Menu Level >
Onboard Serial Port 2	2F8/IRQ3	
UART Mode Select	Normal	
PWRON After PWR-Fail	Off	

IDE HDD Block Mode

This field allows your hard disk controller to use the fast block mode to transfer data to and from your hard disk drive.

IDE DMA Transfer Access

By default, this field is enabled.

On-chip Primary PCI IDE Enabled

By default, this field is enabled.

OnChip Primary/Secondary PCI IDE

The integrated peripheral controller contains an IDE interface with support for two IDE channels. Select *Enabled* to activate each channel separately.

IDE Primary/Secondary Master/Slave PIO

These fields allow your system hard disk controller to work faster. Rather than have the BIOS issue a series of commands that transfer to or from the disk drive, PIO (Programmed Input/Output) allows the BIOS to communicate with the controller and CPU directly.

The system supports five modes, numbered from 0 (default) to 4, which primarily differ in timing. When Auto is selected, the BIOS will select the best available mode.

IDE Primary/Secondary Master/Slave UDMA

These fields allow your system to improve disk I/O throughput to 33Mb/sec with the Ultra DMA/33 feature. The options are *Auto* and *Disabled*.

On-Chip Serial ATA Setting

The fields under the SATA setting include:

SATA Mode	IDE; (other setting is AHCI)
On-Chip Serial ATA Auto	
PATA IDE Mode	Secondary
SATA port	P0, P2 is Primary

USB Controller

The options for this field are *Enabled* and *Disabled*. By default, this field is set to *Enabled*.

USB 2.0 Controller

The options for this field are *Enabled* and *Disabled*. By default, this field is set to *Enabled*. In order to use USB 2.0, necessary OS drivers must be installed first. *Please update your system to Windows 2000 SP4 or Windows XP SP2.*

USB Keyboard Support

The options for this field are *Enabled* and *Disabled*.

AC97 Audio Select

This field, by default, is set to *Auto*.

Power ON Function

This field is related to how the system is powered on – such as with the use of conventional power button, keyboard or hot keys. The default is *BUTTON ONLY*.

KB Power ON Password

This field allows users to set the password when keyboard power on is the mode of the Power ON function.

Hot Key Power ON

This field sets certain keys, also known as hot keys, on the keyboard that can be used as a ‘switch’ to power on the system.

Onboard Serial Port

These fields allow you to select the onboard serial ports and their addresses. The default values for these ports are:

Serial Port 1	3F8/IRQ4
Serial Port 2	2F8/IRQ3

UART Mode Select

This field determines the UART 2 mode in your computer. The default value is *Normal*.

PWRON After PWR-Fail

This field sets the system power status whether *on or off* when power returns to the system from a power failure situation.

Power Management Setup

Phoenix - AwardBIOS CMOS Setup Utility
Power Management Setup

		ITEM HELP
Power-Supply Type	ATX	
ACPI Function	Enabled	
ACPI Suspend	S3(STR)	
RUN VGABIOS if S3 Resume	Auto	Menu Level >
Power Management	User Define	
Video Off Method	V/H SYNC+Blank	
Video Off In Suspend	Yes	
Suspend Type	Stop Grant	
Modem Use IRQ	3	
Suspend Mode	Disabled	
HDD Power Down	Disabled	
Soft-Off by PWR-BTTN	Instant-Off	
CPU THRM-Throttling	75%	
Wake-Up by PCI Card	Disabled	
Power On by Ring	Disabled	
Resume by Alarm	Disabled	
Date (of Month) Alarm	0	
Time (hh:mm:ss) Alarm	0 : 0 : 0	
** Reload Global Timer Events **		
Primary IDE 0	Disabled	
Primary IDE 1	Disabled	
Secondary IDE 0	Disabled	
Secondary IDE 1	Disabled	
FDD, COM, LPT Port	Disabled	
PCI PIRQ[A-D] #	Disabled	

Power Supply Type

The default setting is *ATX*. The other setting is AT mode.

ACPI Function

Enable this function to support ACPI (Advance Configuration and Power Interface).

ACPI Suspend

The default setting of the ACPI Suspend mode is *SI(POS)*.

RUN VGABIOS if S3 Resume

The default setting of this field is *Auto*.

Power Management

This field allows you to select the type of power saving management modes. There are four selections for Power Management.

Min. Power Saving	Minimum power management
Max. Power Saving	Maximum power management.
User Define	Each of the ranges is from 1 min. to 1hr. Except for HDD Power Down which ranges from 1 min. to 15 min.

Video Off Method

This field defines the Video Off features. There are three options.

V/H SYNC + Blank	Default setting, blank the screen and turn off vertical and horizontal scanning.
DPMS	Allows BIOS to control the video display.
Blank Screen	Writes blanks to the video buffer.

Video Off In Suspend

When enabled, the video is off in suspend mode. The default setting is *Yes*.

Suspend Type

The default setting for the Suspend Type field is *Stop Grant*.

Modem Use IRQ

This field sets the IRQ used by the Modem. By default, the setting is 3.

Suspend Mode

When enabled, and after the set time of system inactivity, all devices except the CPU will be shut off.

HDD Power Down

When enabled, and after the set time of system inactivity, the hard disk drive will be powered down while all other devices remain active.

Soft-Off by PWRBTN

This field defines the power-off mode when using an ATX power supply. The *Instant Off* mode allows powering off immediately upon pressing the power button. In the *Delay 4 Sec* mode, the system powers off when the power button is pressed for more than four seconds or enters the suspend mode when pressed for less than 4 seconds.

CPU THRM-Throttling

By default, this field is set to *75%*.

Wake up by PCI Card

By default, this field is disabled.

Power On by Ring

This field enables or disables the power on of the system through the modem connected to the serial port or LAN.

Resume by Alarm

This field enables or disables the resumption of the system operation. When enabled, the user is allowed to set the *Date* and *Time*.

Reload Global Timer Events

The HDD, FDD, COM, LPT Ports, and PCI PIRQ are I/O events that can prevent the system from entering a power saving mode or can awaken the system from such a mode. When an I/O device wants to gain the attention of the operating system, it signals this by causing an IRQ to occur. When the operating system is ready to respond to the request, it interrupts itself and performs the service.

PNP/PCI Configurations

This option configures the PCI bus system. All PCI bus systems on the system use INT#, thus all installed PCI cards must be set to this value.

Phoenix - AwardBIOS CMOS Setup Utility
PnP/PCI Configurations

Init Display First	Onboard	ITEM HELP Menu Level Select Yes if you are using a Plug and Play capable operating system Select No if you need the BIOS to configure non-boot devices
Reset Configuration Data	Disabled	
Resources Controlled By IRQ Resources	Auto (ESCD) Press Enter	
PCI/VGA Palette Snoop	Disabled	
PCI Express relative items Maximum Payload Size	128	

Init Display First

The default setting is *Onboard*.

Reset Configuration Data

This field allows you to determine whether to reset the configuration data or not. The default value is *Disabled*.

Resources Controlled by

This PnP BIOS can configure all of the boot and compatible devices with the use of a PnP operating system such as Windows 95.

PCI/VGA Palette Snoop

Some non-standard VGA display cards may not show colors properly. This field allows you to set whether or not MPEG ISA/VESA VGA cards can work with PCI/VGA. When this field is enabled, a PCI/VGA can work with an MPEG ISA/VESA VGA card. When this field is disabled, a PCI/VGA cannot work with an MPEG ISA/VESA card.

Maximum Payload Size

The default setting of the PCI Express Maximum Payload Size is 128.

PC Health Status

This section shows the parameters in determining the PC Health Status. These parameters include temperatures, fan speeds and voltages.

Phoenix - AwardBIOS CMOS Setup Utility
PC Health Status

Shutdown Temperature	90°C/194°F	ITEM HELP
CPU Warning Temperature	80°C/176°F	
Current System Temp	45°C/113°F	Menu Level >
Current CPU Temp	45°C/113°F	
Vcore(V)	1.02 V	
12 V	1.32 V	
1.8V	1.8V	
+5V	5.25 V	
3.3V	3.37V	
VBAT (V)	3.21 V	
5VSB(V)	5.67 V	

Shutdown Temperature

This field allows the user to set the temperature by which the system automatically shuts down once the threshold temperature is reached. This function can help prevent damage to the system that is caused by overheating.

CPU Warning Temperature

This field allows the user to set the temperature so that when the temperature is reached, the system sounds a warning. This function can help prevent damage to the system that is caused by overheating.

Temperatures/Voltages

These fields are the parameters of the hardware monitoring function feature of the board. The values are read-only values as monitored by the system and show the PC health status.

Frequency/Voltage Control

This section shows the user how to configure the processor frequency.

Phoenix - AwardBIOS CMOS Setup Utility
Frequency/Voltage Control

Auto Detect PCI Clk	Disabled	ITEM HELP
Spread Spectrum	Disabled	Menu Level >
CPU Host/SRC PCI Clock	Default	

Auto Detect PCI Clk

This field enables or disables the auto detection of the PCI clock.

Spread Spectrum Modulated

This field sets the value of the spread spectrum. The default setting is *Disabled*. This field is for CE testing use only.

CPU Host / SRC PCI Clock

This field is set to *Default*.

Load Fail-Safe Defaults

This option allows you to load the troubleshooting default values permanently stored in the BIOS ROM. These default settings are non-optimal and disable all high-performance features.

Load Optimized Defaults

This option allows you to load the default values to your system configuration. These default settings are optimal and enable all high performance features.

Set Supervisor Password

These two options set the system password. Supervisor Password sets a password that will be used to protect the system and Setup utility. User Password sets a password that will be used exclusively on the system. To specify a password, highlight the type you want and press <Enter>. The Enter Password: message prompts on the screen. Type the password, up to eight characters in length, and press <Enter>. The system confirms your password by asking you to type it again. After setting a password, the screen automatically returns to the main screen.

To disable a password, just press the <Enter> key when you are prompted to enter the password. A message will confirm the password to be disabled. Once the password is disabled, the system will boot and you can enter Setup freely.

Save & Exit Setup

This option allows you to determine whether or not to accept the modifications. If you type "Y", you will quit the setup utility and save all changes into the CMOS memory. If you type "N", you will return to Setup utility.

Exit Without Saving

Select this option to exit the Setup utility without saving the changes you have made in this session. Typing "Y" will quit the Setup utility without saving the modifications. Typing "N" will return you to Setup utility.

This page is intentionally left blank.

Drivers Installation

This section describes the installation procedures for software and drivers under the Windows 2000 and Windows XP. The software and drivers are included with the board. If you find the items missing, please contact the vendor where you made the purchase. The contents of this section include the following:

Intel Chipset Software Intallation Utility	46
VGA Drivers Installation	47
AC97 Codec Audio Driver Installation	48
LAN Drivers Installation	50

IMPORTANT NOTE:

After installing your Windows operating system (Windows 2000/ XP), you must install first the Intel Chipset Software Installation Utility before proceeding with the drivers installation.

Intel Chipset Software Installation Utility

The Intel Chipset Drivers should be installed first before the software drivers to enable Plug & Play INF support for Intel chipset components. Follow the instructions below to complete the installation under Windows 2000/XP.

1. Insert the CD that comes with the board. Click **Intel** at the left side, then **Intel(R) I945GM/GME/GSE Chipset Drivers**.

2. Click **Intel(R) Chipset Software Installation Utility**.



3. When the welcome screen to the Intel(R) Chipset Software Installation Utility appears, click **Next** to continue.

4. Click **Yes** to accept the software license agreement and proceed with the installation process.

5. On Readme Information screen, click **Next** to continue the installation.

6. The Setup process is now complete. Click **Finish** to restart the computer and for changes to take effect.

VGA Drivers Installation

To install the VGA drivers, follow the steps below to proceed with the installation.

1. Insert the CD that comes with the board. Click **Intel** at the left side, then **Intel(R) I945GM/GME/GSE Chipset Drivers**.
2. Click **Intel(R) I945GM/GME/GSE Chipset Family Graphics Driver**.



3. When the welcome screen of the Intel(R) Graphics Media Accelerator Driver appears, click **Next** to continue.
4. Click **Yes** to agree with the license agreement and continue the installation.
5. Click **Next** in the Readme File Information window.
6. Click **Next** in the Setup Progress window.
7. Setup is now complete. Click **Finish** to restart the computer and for changes to take effect.

AC97 Codec Audio Driver Installation

Follow the steps below to install the Realtek AC97 Codec Audio Drivers.

1. Insert the CD that comes with the board. Click **Intel** at the left side, then **Intel(R) I945GM/GME/GSE Chipset Drivers**, and then **Realtek Audio Driver**.



2. Click **Realtek High Definition Codec Audio Driver**.



3. When the welcome screen to the InstallShield Wizard for **Realtek High Definition Codec Audio Driver** appears, click **Next** to start the installation.

4. When the InstallShieldWizard has finished performing maintenance operations on Realtek High Definition Audio Driver, click ***Finish*** to restart the computer.

LAN Drivers Installation

Follow the steps below to install Intel PRO LAN drivers.

1. Insert the CD that comes with the board. Click **LAN Card** at the left side and then **Intel(R) PRO 82574L LAN Drivers**.



2. In the Intel® Network Connections screen*, click **Install Drivers and Software**.



*Under Windows 2000, driver installation will require the Windows Management Instrumentation Service running in order to proceed. Refer to this information at the end of this section.

3. In the welcome screen of the InstallShield Wizard for Intel(R) Network Connections, click *Next*.

4. In the Setup Options, click the checkbox as shown below and click *Next*.

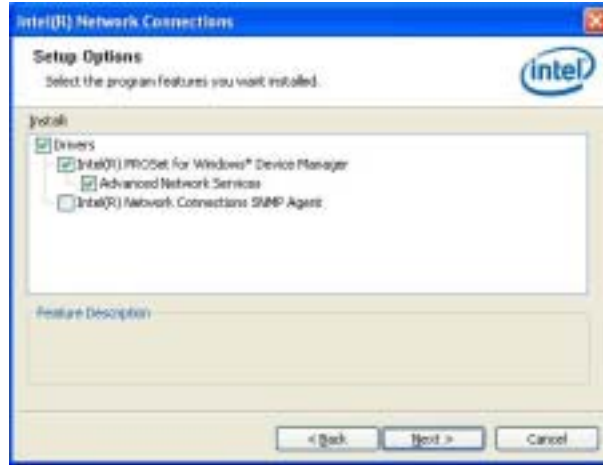

4. In the InstallShield Wizard screen, click *Install* to begin the installation.

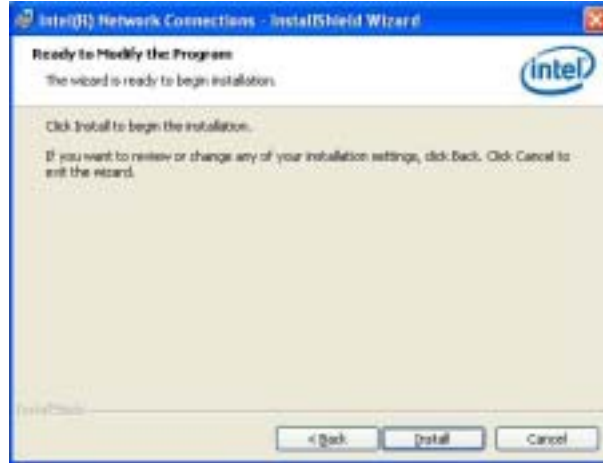

5. InstallShield Wizard is completed. Click *Finish* to exit the Wizard.

The Windows Management Instrumentation Service

During the installation of the *Intel(R) PRO 82574L LAN* drivers under Windows 2000, the message below asking to start the Windows Management Instrument Service will appear.



At this moment, click **OK**, and proceed to run the service requested. On the Windows desktop, right click the **My Computer** icon and click **Manage**.

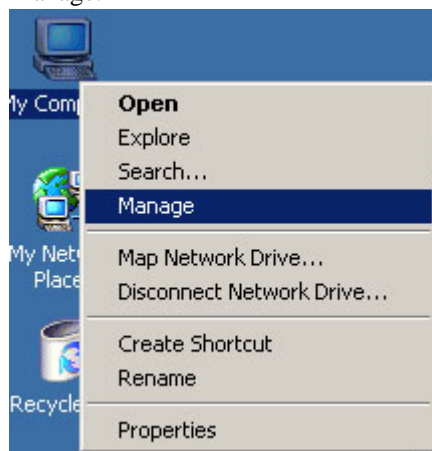

When the Computer Management properties appear, double click **Services and Applications** tab at the bottom and then click **Services**. Double click two Services names including **Windows Management Instrumentation** and **Windows Management Instrumentation Driver Extensions** in order to configure their **Startup type** as **Automatic** as shown below. After this step, you can go back to install the LAN driver.

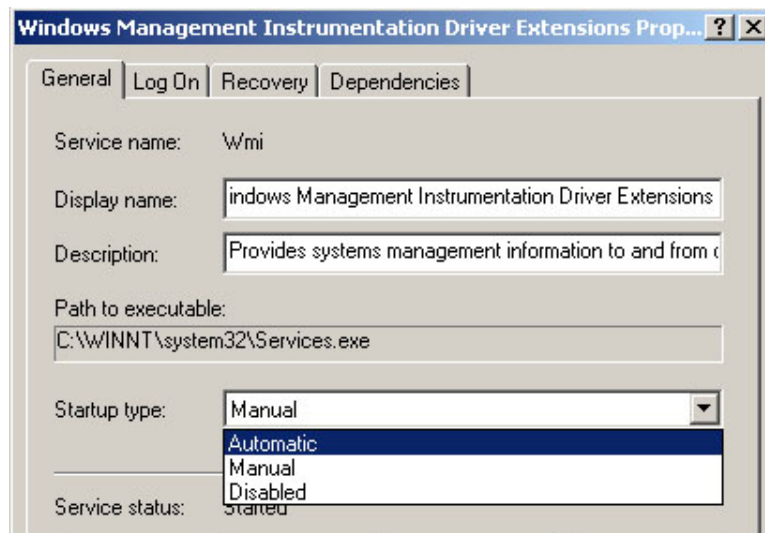
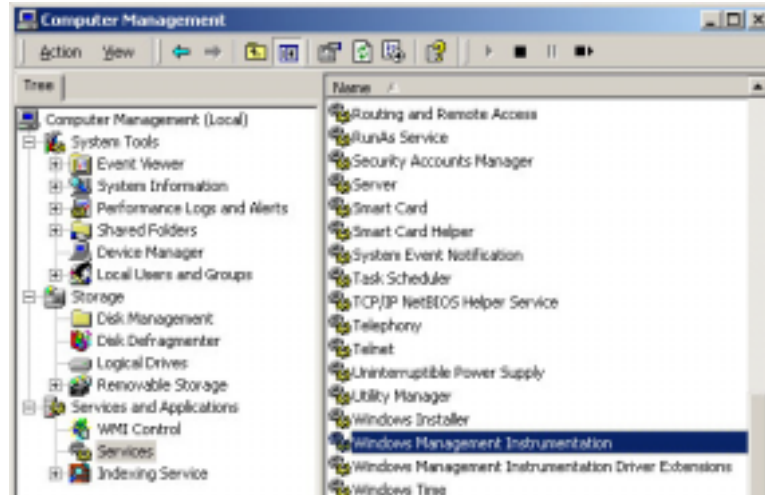

Appendix

A. I/O Port Address Map

Each peripheral device in the system is assigned a set of I/O port addresses which also becomes the identity of the device. The following table lists the I/O port addresses used.

Address	Device Description
000h - 01Fh	DMA Controller #1
020h - 03Fh	Interrupt Controller #1
040h - 05Fh	Timer
060h - 06Fh	Keyboard Controller
070h - 07Fh	Real Time Clock, NMI
080h - 09Fh	DMA Page Register
0A0h - 0BFh	Interrupt Controller #2
0C0h - 0DFh	DMA Controller #2
0F0h	Clear Math Coprocessor Busy Signal
0F1h	Reset Math Coprocessor
1F0h - 1F7h	IDE Interface
278 - 27F	Parallel Port #2(LPT2)
2F8h - 2FFh	Serial Port #2(COM2)
2B0 - 2DF	Graphics adapter Controller
378h - 3FFh	Parallel Port #1(LPT1)
360 - 36F	Network Ports
3B0 - 3BF	Monochrome & Printer adapter
3C0 - 3CF	EGA adapter
3D0 - 3DF	CGA adapter
3F0h - 3F7h	Floppy Disk Controller
3F8h - 3FFh	Serial Port #1(COM1)

B. Interrupt Request Lines (IRQ)

Peripheral devices use interrupt request lines to notify CPU for the service required. The following table shows the IRQ used by the devices on board.

Level	Function
IRQ0	System Timer Output
IRQ1	Keyboard
IRQ2	Interrupt Cascade
IRQ3	Serial Port #2
IRQ4	Serial Port #1
IRQ5	Reserved
IRQ6	Floppy Disk Controller
IRQ7	Parallel Port #1
IRQ8	Real Time Clock
IRQ9	Reserved
IRQ10	Reserved
IRQ11	Reserved
IRQ12	PS/2 Mouse
IRQ13	80287
IRQ14	Primary IDE
IRQ15	Secondary IDE

C. Watchdog Timer Configuration

The WDT is used to generate a variety of output signals after a user programmable count. The WDT is suitable for use in the prevention of system lock-up, such as when software becomes trapped in a deadlock. Under these sorts of circumstances, the timer will count to zero and the selected outputs will be driven. Under normal circumstance, the user will restart the WDT at regular intervals before the timer counts to zero.

SAMPLE CODE:

```

=====
//
// THIS CODE AND INFORMATION IS PROVIDED "AS IS" WITHOUT WARRANTY OF ANY
// KIND, EITHER EXPRESSED OR IMPLIED, INCLUDING BUT NOT LIMITED TO THE
// IMPLIED WARRANTIES OF MERCHANTABILITY AND/OR FITNESS FOR A PARTICULAR
// PURPOSE.
//
=====
#include <stdio.h>
#include <stdlib.h>
#include "W627EHF.H"
=====
int main (int argc, char *argv[])
void copyright(void);
void EnableWDT(int);
void DisableWDT(void);
=====
int main (int argc, char *argv[])
{
    unsigned char bBuf;
    unsigned char bTime;
    char **endptr;

    copyright();

    if (argc != 2)
    {
        printf(" Parameter incorrect!!\n");
        return 1;
    }

    if (Init_W627EHF() == 0)
    {
        printf(" Winbond 83627HF is not detected, program abort.\n");
        return 1;
    }
    bTime = strtol (argv[1], endptr, 10);
    printf("System will reset after %d seconds\n", bTime);

    EnableWDT(bTime);

    return 0;
}
=====

```

```

void copyright(void)
{
    printf("\n===== Winbond 83627EHF Watch Timer Tester (AUTO DETECT) =====\n")
        "      Usage : W627E_WD reset_time\n"
        "      Ex : W627E_WD 3 => reset system after 3 second\n"
        "      W627E_WD 0 => disable watch dog timer\n";
}
//=====
void EnableWDT(int interval)
{
    unsigned char bBuf;

    bBuf = Get_W627EHF_Reg( 0x2D);
    bBuf &= (!0x01);
    Set_W627EHF_Reg( 0x2D, bBuf);           //Enable WDTO

    Set_W627EHF_LD( 0x08);                 //switch to logic device 8
    Set_W627EHF_Reg( 0x30, 0x01);         //enable timer

    bBuf = Get_W627EHF_Reg( 0xF5);
    bBuf &= (!0x08);
    Set_W627EHF_Reg( 0xF5, bBuf);         //count mode is second

    Set_W627EHF_Reg( 0xF6, interval);     //set timer
}
//=====
void DisableWDT(void)
{
    Set_W627EHF_LD(0x08);                 //switch to logic device 8
    Set_W627EHF_Reg(0xF6, 0x00);         //clear watchdog timer
    Set_W627EHF_Reg(0x30, 0x00);         //watchdog disabled
}
//=====

```

```

=====
//
// THIS CODE AND INFORMATION IS PROVIDED "AS IS" WITHOUT WARRANTY OF ANY
// KIND, EITHER EXPRESSED OR IMPLIED, INCLUDING BUT NOT LIMITED TO THE
// IMPLIED WARRANTIES OF MERCHANTABILITY AND/OR FITNESS FOR A PARTICULAR
// PURPOSE.
//
=====
#include "W627EHF.H"
#include <dos.h>
=====
unsigned int W627EHF_BASE;
void Unlock_W627EHF(void);
void Lock_W627EHF(void);
=====
unsigned int Init_W627EHF(void)
{
    unsigned int result;
    unsigned char ucDid;

    W627EHF_BASE = 0x2E;
    result = W627EHF_BASE;

    ucDid = Get_W627EHF_Reg(0x20);
    if (ucDid == 0x88)
    {
        goto Init_Finish;
    }

    W627EHF_BASE = 0x4E;
    result = W627EHF_BASE;
    ucDid = Get_W627EHF_Reg(0x20);
    if (ucDid == 0x88)
    {
        goto Init_Finish;
    }

    W627EHF_BASE = 0x00;
    result = W627EHF_BASE;

Init_Finish:
    return (result);
}
=====
void Unlock_W627EHF(void)
{
    outportb(W627EHF_INDEX_PORT, W627EHF_UNLOCK);
    outportb(W627EHF_INDEX_PORT, W627EHF_UNLOCK);
}
=====
void Lock_W627EHF(void)
{
    outportb(W627EHF_INDEX_PORT, W627EHF_LOCK);
}
=====
void Set_W627EHF_LD(unsigned char LD)
{
    Unlock_W627EHF();
    outportb(W627EHF_INDEX_PORT, W627EHF_REG_LD);
    outportb(W627EHF_DATA_PORT, LD);
    Lock_W627EHF();
}

```

```

=====
void Set_W627EHF_Reg( unsigned char REG, unsigned char DATA)
{
    Unlock_W627EHF();
    outportb(W627EHF_INDEX_PORT, REG);
    outportb(W627EHF_DATA_PORT, DATA);
    Lock_W627EHF();
}
=====
unsigned char Get_W627EHF_Reg(unsigned char REG)
{
    unsigned char Result;
    Unlock_W627EHF();
    outportb(W627EHF_INDEX_PORT, REG);
    Result = inportb(W627EHF_DATA_PORT);
    Lock_W627EHF();
    return Result;
}
=====

=====
//
// THIS CODE AND INFORMATION IS PROVIDED "AS IS" WITHOUT WARRANTY OF ANY
// KIND, EITHER EXPRESSED OR IMPLIED, INCLUDING BUT NOT LIMITED TO THE
// IMPLIED WARRANTIES OF MERCHANTABILITY AND/OR FITNESS FOR A PARTICULAR
// PURPOSE.
//
//=====
#ifndef __W627EHF_H
#define __W627EHF_H                1
//=====
#define W627EHF_INDEX_PORT        (W627EHF_BASE)
#define W627EHF_DATA_PORT        (W627EHF_BASE+1)
//=====
#define W627EHF_REG_LD            0x07
//=====
#define W627EHF_UNLOCK            0x87
#define W627EHF_LOCK              0xAA
//=====
unsigned int Init_W627EHF(void);
void Set_W627EHF_LD( unsigned char);
void Set_W627EHF_Reg( unsigned char, unsigned char);
unsigned char Get_W627EHF_Reg( unsigned char);
//=====
#endif __W627EHF_H

```