

IB881

Intel Pentium® M
3.5-inch Disk Size SBC

USER'S MANUAL

Version 1.0A

Acknowledgments

Award is a registered trademark of Award Software International, Inc.

PS/2 is a trademark of International Business Machines Corporation.

Intel and Pentium M are registered trademarks of Intel Corporation.

Microsoft Windows is a registered trademark of Microsoft Corporation.

Winbond is a registered trademark of Winbond Electronics Corporation.

All other product names or trademarks are properties of their respective owners.

Table of Contents

Introduction	1
Product Description.....	1
Checklist.....	2
IB881 Specifications	3
Board Dimensions	4
Installations	5
Installing the CPU	6
Installing the Memory	7
Setting the Jumpers	8
Connectors on IB881.....	11
BIOS Setup.....	21
Drivers Installation	45
Intel Chipset Software Intallation Utility	46
VGA Drivers Installation	48
AC97 Codec Audio Driver Installation.....	49
Intel PRO LAN Drivers Installation.....	50
Appendix	51
A. I/O Port Address Map.....	51
B. Interrupt Request Lines (IRQ)	52
C. Watchdog Timer Configuration.....	53
D. IB881 CMOS Backup Feature	56

This page is intentionally left blank.

Introduction

Product Description

The IB881 3.5-inch disk size SBC incorporates the Intel® advanced 855GME/852GM Chipset that contains two core components: the Memory Controller Hub (GMCH) and ICH4. The GMCH integrates a 400MHz Pentium® M processor front side bus controller, integrated graphics controller hub, integrated LVDS interface, two digital video out ports multiplexed with an AGP 4x controller, a 200/266/ 333MHz DDR-SDRAM controller, and a high-speed accelerated hub architecture interface for communication with the ICH4.

The ICH4 integrates an Ultra ATA 100/66/33 controller, USB host controller that supports the USB 1.1 and USB 2.0 specification, LPC interface, FWH Flash BIOS interface controller, AC'97 digital controller and a hub interface for communication with the GMCH.

The Pentium M processor is a higher performance, lower power processor with several microarchitectural enhancements over existing Intel low-power processors. Some key features of the Pentium M processor microarchitecture include dynamic execution, data pre-fetch logic, 400MHz source-synchronous Front Side Bus (FSB), on-die 1 Mbyte second level cache (on-die 512Kbyte second level cache on Celeron M processor) with advanced transfer cache architecture, streaming SIMD extensions 2 (SSE2), and Enhanced Intel SpeedStep technology.

IB881 FEATURES:

- **Intel® 82855GME/82852GM chipset**
- **Supports Intel® Pentium® M, Celeron® M**
- **SO-DIMM socket supports up to 1GB DDR SDRAM**
- **10/100 BaseT Ethernet with RJ45 connector**
- **24-bit LVDS, VGA CRT support**
- **USB x4, RS232 COM x2, PS/2 Mouse/Keyboard**
- **IDE x2, FDD, LPT, 12V power connector, PC/104+**
- **102.24mm x 148.03mm**

Checklist

Your IB881 package should include the items listed below.

- The IB881 Pentium® M 3.5-inch Disk Size SBC
- This User's Manual
- 1 CD containing chipset drivers and flash memory utility
- Options:
 - IB32 - Cable kit with IDE, COM, Printer, Audio, USB, PS/2 Y cable
 - IB33 - Kit with ATX power switch, power cable
 - IB881SW-R - ATX power switch board for IB881
 - IB881PW-R - ATX power board for IB881
 - ICOOL010-P - Heatsink for IB881 (Socket 478)

IB881 Specifications

Product Name	IB881
Form Factor	3 1/2 little board
Processor	Intel Pentium M /Celeron M Processor
CPU Voltage	0.7~1.7V(IMVP4)
System Speed	Pentium M/Celeron M 900MHz-1.7GHz (Low-Power, Low-voltage)
CPU External Clock / FSB	400MHz
Green /APM	APM1.2
CPU Socket	None
Major Chipset	Intel 82855GME/82852GM chipset Intel GMCH 82855GME/82852GM 732-pin uFCBGA Intel ICH4 82801DB 421-pin BGA Intel FWH 82802ABA or compatible
BIOS	Phoenix/Award ROM
Cache	256K/1M Level2 (CPU integrated)
Memory	One SO-DIMM socket for DDR SDRAM Module; 2.5V Support
Super I/O	Winbond 83627 1 Parallel (LPT1)*1 Serial*2 (COM1 & COM2); FDC 2.88MB (3 Mode Support)
Onboard VGA	Intel GMCH 82855GME/82852GM 732-pin uFCBGA integrated support CRT and LVDS ;
Keyboard/Mouse Controller	Winbond 83627HF built-in
Dual IDE Channel	Primary/Secondary IDE Channel support 44pin for HDD and CDROM
Onboard PC104+	PC104+ connector support four master PCI Bus/ 32 Bits @ 33MHz
Onboard LAN	Intel 82562ET 10 /100 BaseT support, full duplex 1xRJ-45 connector and 2x LED (LINK /Active on front panel
USB	Total 4 ports 2 USB ports connector for front panel and 2 ports for pin header
Keyboard / Mouse	Combo PS/2 Type (Keyboard & Mouse) signal both on connector

Board Dimensions

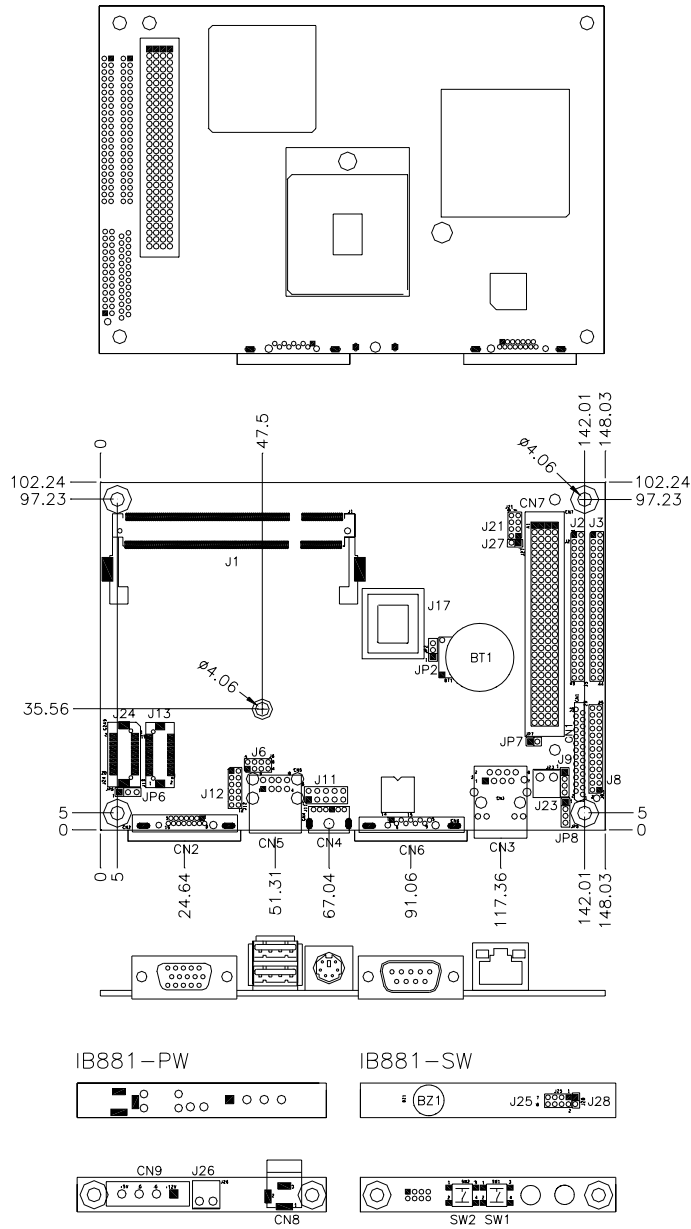

Installations

This section provides information on how to use the jumpers and connectors on the IB881 in order to set up a workable system. The topics covered are:

Installing the CPU	6
Installing the Memory	7
Setting the Jumpers	8
Connectors on IB881	11

Installing the CPU

The IB881 board supports a Socket 479 processor socket for Intel® Pentium® M or Celeron® M processors.

The processor socket comes with a screw to secure the processor. As shown in the left picture below, loosen the screw first before inserting the processor. Place the processor into the socket by making sure the notch on the corner of the CPU corresponds with the notch on the inside of the socket. Once the processor has slide into the socket, fasten the screw. Refer to the figures below.

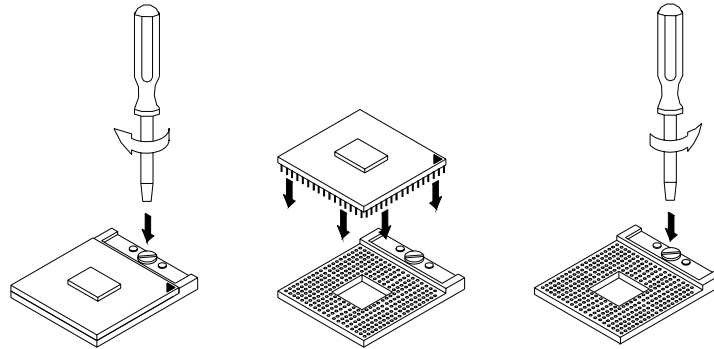

NOTE: Ensure that the CPU heat sink and the CPU top surface are in total contact to avoid CPU overheating problem that would cause your system to hang or be unstable.

Installing the Memory

The IB881 board supports one SODIMM DDR memory socket for a maximum total memory. The memory module capacities supported are 128MB, 256MB, 512MB and 1GB.

Installing and Removing Memory Modules

To install the DDR modules, locate the memory slot on the board and perform the following steps:

1. Hold the DDR module so that the key of the DDR module align with those on the memory slot. Insert the module into the socket at a slight angle (approximately 30 degrees). Note that the socket and module are both keyed, which means that the module can be installed only in one direction.
2. To seat the memory module into the socket, apply firm and even pressure to each end of the module until you feel it slip down into the socket.
3. With the module properly seated in the socket, rotate the module downward. Continue pressing downward until the clips at each end lock into position.
4. To remove the DDR module, press the clips with both hands.

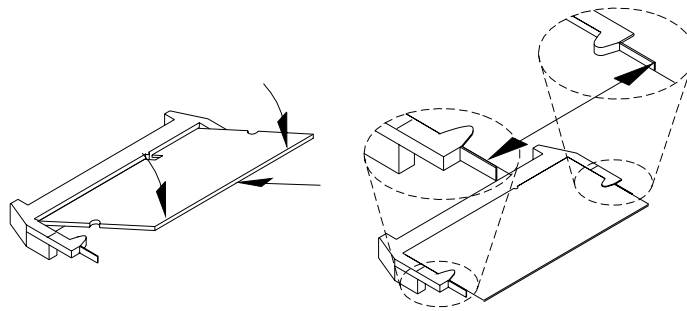

Setting the Jumpers

Jumpers are used on IB881 to select various settings and features according to your needs and applications. Contact your supplier if you have doubts about the best configuration for your needs. The following lists the connectors on IB881 and their respective functions.

Jumper Locations on IB881	9
JP2: Clear CMOS Setting	10
JP6: LVDS VDD Select (5V / 3.3V)	10
JP8: AT/ATX Power Mode Setting	10

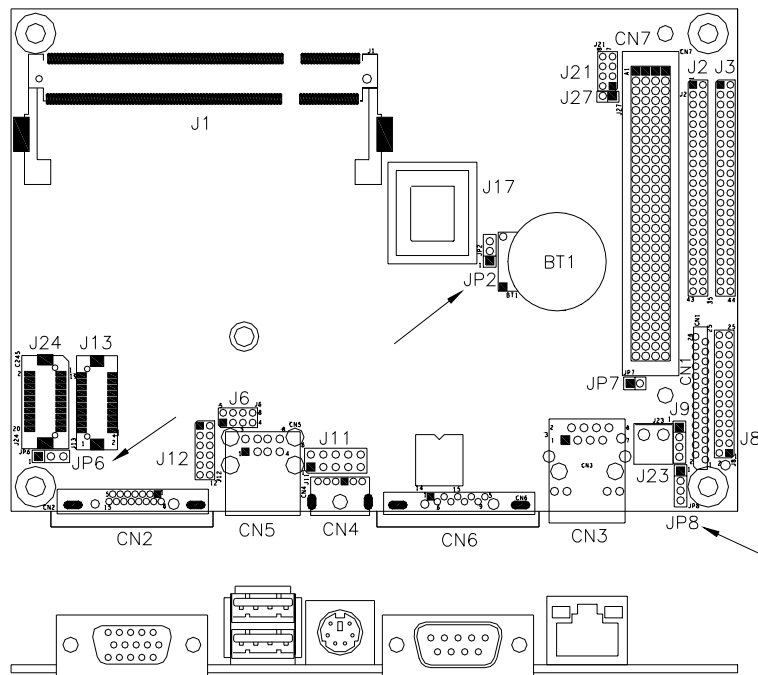

Jumper Locations on IB881





Jumpers on IB881.....	Page
JP2: Clear CMOS Setting.....	10
JP6: LVDS VDD Select (5V / 3.3V).....	10
JP8: AT/ATX Power Mode Setting.....	10

JP2: Clear CMOS Setting



Use JP2 to clear the CMOS contents. *Note that the power connector should be disconnected from the board before clearing CMOS.*

JP2	Function
 1 2 3	Normal (default)
 1 2 3	Clear CMOS

JP6: LVDS VDD Select (5V / 3.3V)

JP6	VDD Setting
 1 2 3	3.3V
 1 2 3	5V

JP8: AT/ATX Power Mode Setting

JP8	Setting	Power Mode
 1 ■ ○ ○ ○	1-2, 3-4 Short	ATX Mode (default)
 1 ■ ○ ○ ○	2-3 Short	AT Mode

Connectors on IB881

The connectors on IB881 allows you to connect external devices such as keyboard, floppy disk drives, hard disk drives, printers, etc. The following table lists the connectors on IB881 and their respective functions.

Connector Locations on IB881.....	12
CN1: Floppy Drive Connector	13
CN2: VGA CRT Connector	13
CN3:RJ45 Connector	13
CN4: PS/2 Keyboard and Mouse Connector.....	14
CN5, J6: USB Connectors.....	14
CN6, J11: Serial Ports	14
CN7: PC104+ Connector.....	15
PC/104-Plus Bus Signal Assignments.....	15
J2, J3: IDE Connectors.....	16
J8: Parallel Port Connector.....	17
J9: IrDA Connector	17
J12: External Audio Connector	17
J13, J24: LVDS Connectors (1st channel, 2nd channel)	18
J21: Function Connector	18
J23: Power DC-In.....	19
J27: Buzzer Connector	19

Connector Locations on IB881

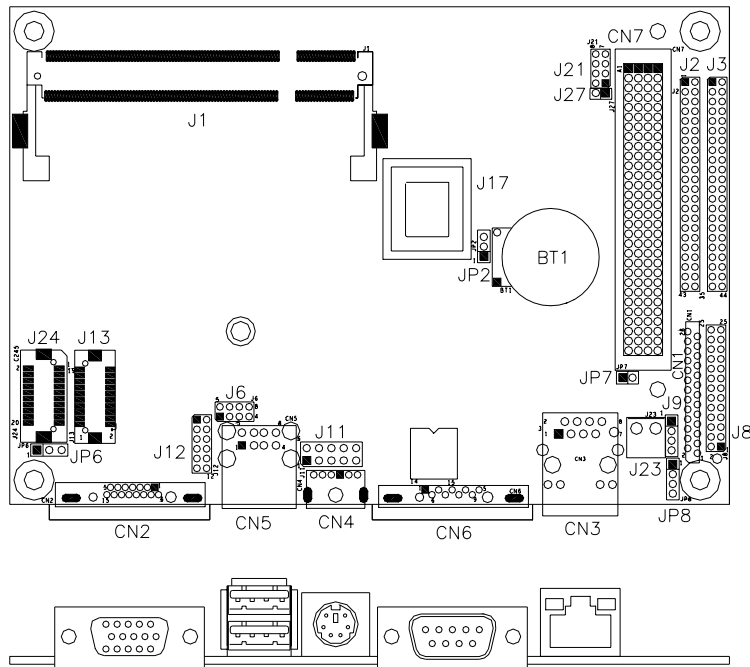

Connectors on IB881	Page
CN1: Floppy Drive Connector.....	13
CN2: VGA CRT Connector.....	13
CN3: RJ45 Connector.....	13
CN4: PS/2 Keyboard and Mouse Connector	14
CN5, J6: USB Connectors	14
CN6, J11: Serial Ports.....	14
CN7: PC104+ Connector.....	15
PC/104-Plus Bus Signal Assignments	15
J2, J3: IDE Connectors	16
J8: Parallel Port Connector	17
J9: IrDA Connector	17
J12: External Audio Connector	17
J13, J24: LVDS Connectors (1st channel, 2nd channel)	18
J21: Function Connector.....	18
J23: Power DC-In	19
J27: Buzzer Connector.....	19

CN1: Floppy Drive Connector

CN1 is a slim 26-pin connector and will support up to 2.88MB FDD.

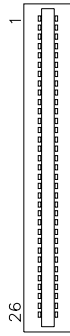

Signal Name	Pin #	Pin #	Signal Name
VCC	1	2	INDEX
VCC	3	4	DRV_SEL
VCC	5	6	DSK_CH
NC	7	8	NC
NC	9	10	MOTOR
DINST	11	12	DIR
NC	13	14	STEP
GND	15	16	WDATA
GND	17	18	WGATE
GND	19	20	TRACK
NC	21	22	WPROT
GND	23	24	RDATA
GND	25	26	SIDE

CN2: VGA CRT Connector

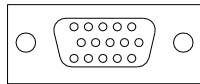

Signal Name	Pin	Pin	Signal Name
Red	1	2	Green
Blue	3	4	NC
GND	5	6	GND
GND	7	8	GND
Vcc	9	10	GND
N.C.	11	12	DDCDA
HSYNC	13	14	VSYNC
DDCCLK	15		

CN3: RJ45 Connector

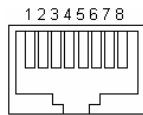

Pin #	Signal Name
1	TD+
2	TD-
3	RD+
4	RJ45-4A
5	RJ45-5A
6	RD-
7	RJ45-7A
8	RJ45-8A

CN4: PS/2 Keyboard and Mouse Connector

CN4 uses a Y-cable with dual D-connectors for a PS/2 keyboard and a PS/2 mouse.

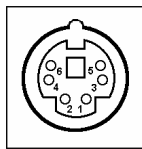

Pin #	Signal Name
1	Mouse data
2	Keyboard data
3	Ground
4	Vcc
5	Mouse Clock
6	Keyboard Clock

CN5, J6: USB Connectors

The J6 USB pin header connector supports two USB 2.0 ports via an optional USB cable. The IB881 also supports an embedded USB connector, CN5, which supports another two USB ports.

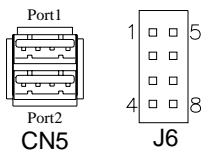

Signal Name	Pin	Pin	Signal Name
Vcc	1	5	Ground
USB0-	2	6	USB1+
USB0+	3	7	USB1-
Ground	4	8	Vcc

CN6, J11: Serial Ports

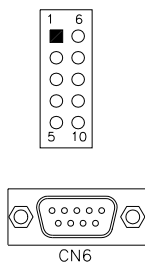

Pin #	Signal Name (RS-232)
1	DCD, Data carrier detect
2	RXD, Receive data
3	TXD, Transmit data
4	DTR, Data terminal ready
5	Ground
6	DSR, Data set ready
7	RTS, Request to send
8	CTS, Clear to send
9	RI, Ring indicator
10	No Connect.

CN6 is the D-sub type COM1 serial port connector, while J11 (COM2) is a pin header type COM2 serial port connector.

**CN7: PC104+ Connector
PC/104-Plus Bus Signal Assignments**

J3/P3				
Pin	A	B	C	D
1	GND/5.0V KEY ²	Reserved	+5	AD00
2	VI/O	AD02	AD01	+5V
3	AD05	GND	AD04	AD03
4	C/BE0*	AD07	GND	AD06
5	GND	AD09	AD08	GND
6	AD11	VI/O	AD10	M66EN
7	AD14	AD13	GND	AD12
8	+3.3V	C/BE1*	AD15	+3.3V
9	SERR*	GND	SB0*	PAR
10	GND	PERR*	+3.3V	SDONE
11	STOP*	+3.3V	LOCK*	GND
12	+3.3V	TRDY*	GND	DEVSEL*
13	FRAME*	GND	IRDY*	+3.3V
14	GND	AD16	+3.3V	C/BE2*
15	AD18	+3.3V	AD17	GND
16	AD21	AD20	GND	AD19
17	+3.3V	AD23	AD22	+3.3V
18	IDSEL0	GND	IDSEL1	IDSEL2
19	AD24	C/BE3*	VI/O	IDSEL3
20	GND	AD26	AD25	GND
21	AD29	+5V	AD28	AD27
22	+5V	AD30	GND	AD31
23	REQ0*	GND	REQ1*	VI/O
24	GND	REQ2*	+5V	GNT0*
25	GNT1*	VI/O	GNT2*	GND
26	+5V	CLK0	GND	CLK1
27	CLK2	+5V	CLK3	GND
28	GND	INTD*	+5V	RST*
29	+12V	INTA*	INTB*	INTC*
30	-12V	Reserved	Reserved	GND/3.3V KEY ²

* The shaded area denotes power or ground signals.

* The KEY pins are to guarantee proper module installation. Pin-A1 will be removed and the female side plugged for 5.0V I/O signals and Pin-D30 will be modified in the same manner for 3.3V I/O. It is recommended that both KEY pins (A1 and D30) be electrically connected for GND for shielding.

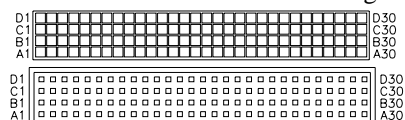

J2, J3: IDE Connectors

J2 is the primary IDE connector and J3 is the secondary IDE connector.

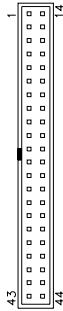

Signal Name	Pin #	Pin #	Signal Name
Reset IDE	1	2	Ground
Host data 7	3	4	Host data 8
Host data 6	5	6	Host data 9
Host data 5	7	8	Host data 10
Host data 4	9	10	Host data 11
Host data 3	11	12	Host data 12
Host data 2	13	14	Host data 13
Host data 1	15	16	Host data 14
Host data 0	17	18	Host data 15
Ground	19	20	Key
DRQ0	21	22	Ground
Host IOW	23	24	Ground
Host IOR	25	26	Ground
IOCHRDY	27	28	Host ALE
DACK0	29	30	Ground
IRQ14	31	32	No connect
Address 1	33	34	No connect
Address 0	35	36	Address 2
Chip select 0	37	38	Chip select 1
Activity	39	40	Ground
Vcc	41	42	Vcc
Ground	43	44	N.C.

J8: Parallel Port Connector

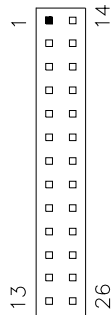

Signal Name	Pin #	Pin #	Signal Name
Line printer strobe	1	14	AutoFeed
PD0, parallel data 0	2	15	Error
PD1, parallel data 1	3	16	Initialize
PD2, parallel data 2	4	17	Select
PD3, parallel data 3	5	18	Ground
PD4, parallel data 4	6	19	Ground
PD5, parallel data 5	7	20	Ground
PD6, parallel data 6	8	21	Ground
PD7, parallel data 7	9	22	Ground
ACK, acknowledge	10	23	Ground
Busy	11	24	Ground
Paper empty	12	25	Ground
Select	13	N/A	N/A

J9: IrDA Connector

J9 is used for an optional IrDA connector for wireless communication.

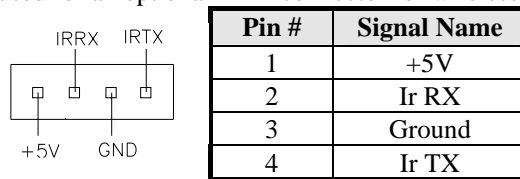

J12: External Audio Connector

J12 is a 12-pin header that is used to connect to the optional audio cable card that integrates jacks for Line In, Line Out and Mic.

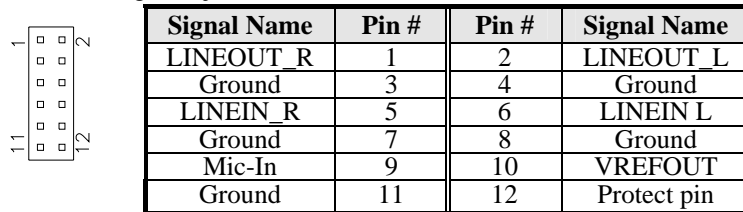

J13, J24: LVDS Connectors (1st channel, 2nd channel)

The LVDS connectors on board support 24-bit or 48-bit.

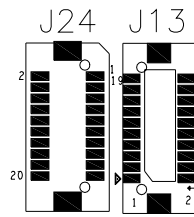

Signal Name	Pin #	Pin #	Signal Name
TX0-	2	1	TX0+
Ground	4	3	Ground
TX1-	6	5	TX1+
*5V/3.3V	8	7	Ground
TX3-	10	9	TX3+
TX2-	12	11	TX2+
Ground	14	13	Ground
TXC-	16	15	TXC+
*5V/3.3V	18	17	ENABKL
NC	20	19	NC

*Depends on JP6 setting (1-2 for 3.3V/default, 2-3 for 5V).

J21: Function Connector



Signal Name	Pin	Pin	Signal Name
GND	1	2	VCC
GND	3	4	PS_ON
GND	5	6	Reset
+5V	7	8	IN0

Power LED: Pins 1(GND) and 2(Power)

The power LED indicates the status of the main power switch.

ATX Power ON Switch: Pins 3 and 4

This 2-pin connector is an “ATX Power Supply On/Off Switch” on the system that connects to the power switch on the case. When pressed, the power switch will force the system to power on. When pressed again, it will force the system to power off.

Reset Switch: Pins 5 and 6

The reset switch allows the user to reset the system without turning the main power switch off and then on again. Orientation is not required when making a connection to this header.

HDD LED: Pins 7(power) and 8(HDD/LED)

The power LED indicates the status of the HDD.

J23: Power DC-In

Pin #	Signal Name
1	DC In (12V only)
2	Ground

J27: Buzzer Connector

Pin #	Signal Name
1	Vcc
2	Speaker Signal

This page is intentionally left blank.

BIOS Setup

This chapter describes the different settings available in the Award BIOS that comes with the board. The topics covered in this chapter are as follows:

BIOS Introduction	22
BIOS Setup.....	22
Standard CMOS Setup	24
Advanced BIOS Features	27
Advanced Chipset Features	30
Integrated Peripherals	33
Power Management Setup	37
PNP/PCI Configurations	40
PC Health Status.....	41
Frequency/Voltage Control	42
Load Fail-Safe Defaults.....	43
Load Optimized Defaults	43
Set Password	43
Save & Exit Setup	43
Exit Without Saving	43

BIOS Introduction

The Award BIOS (Basic Input/Output System) installed in your computer system's ROM supports Intel processors. The BIOS provides critical low-level support for a standard device such as disk drives, serial ports and parallel ports. It also adds virus and password protection as well as special support for detailed fine-tuning of the chipset controlling the entire system.

BIOS Setup

The Award BIOS provides a Setup utility program for specifying the system configurations and settings. The BIOS ROM of the system stores the Setup utility. When you turn on the computer, the Award BIOS is immediately activated. Pressing the key immediately allows you to enter the Setup utility. If you are a little bit late pressing the key, POST (Power On Self Test) will continue with its test routines, thus preventing you from invoking the Setup. If you still wish to enter Setup, restart the system by pressing the "Reset" button or simultaneously pressing the <Ctrl>, <Alt> and <Delete> keys. You can also restart by turning the system Off and back On again. The following message will appear on the screen:

Press to Enter Setup

In general, you press the arrow keys to highlight items, <Enter> to select, the <PgUp> and <PgDn> keys to change entries, <F1> for help and <Esc> to quit.

When you enter the Setup utility, the Main Menu screen will appear on the screen. The Main Menu allows you to select from various setup functions and exit choices.

Phoenix - AwardBIOS CMOS Setup Utility

Standard CMOS Features	Frequency/Voltage Control
Advanced BIOS Features	Load Fail-Safe Defaults
Advanced Chipset Features	Load Optimized Defaults
Integrated Peripherals	Set Password
Power Management Setup	Save & Exit Setup
PnP/PCI Configurations	Exit Without Saving
PC Health Status	
ESC : Quit	↑ ↓ → ← : Select Item
F10 : Save & Exit Setup	
Time, Date, Hard Disk Type...	

The section below the setup items of the Main Menu displays the control keys for this menu. At the bottom of the Main Menu just below the control keys section, there is another section, which displays information on the currently highlighted item in the list.

Note: *If the system cannot boot after making and saving system changes with Setup, the Award BIOS supports an override to the CMOS settings that resets your system to its default.*

Warning: *It is strongly recommended that you avoid making any changes to the chipset defaults. These defaults have been carefully chosen by both Award and your system manufacturer to provide the absolute maximum performance and reliability. Changing the defaults could cause the system to become unstable and crash in some cases.*

Standard CMOS Setup

“Standard CMOS Setup” choice allows you to record some basic hardware configurations in your computer system and set the system clock and error handling. If the motherboard is already installed in a working system, you will not need to select this option. You will need to run the Standard CMOS option, however, if you change your system hardware configurations, the onboard battery fails, or the configuration stored in the CMOS memory was lost or damaged.

Phoenix - AwardBIOS CMOS Setup Utility
Standard CMOS Features

		Item Help
Date (mm:dd:yy)	Wed, Apr 28, 2004	Menu Level >
Time (hh:mm:ss)	00 : 00 : 00	
IDE Primary Master	None	Change the day, month, Year and century
IDE Primary Slave	None	
IDE Secondary Master	None	
IDE Secondary Slave	None	
Drive A	1.44M, 3.5 in.	
Drive B	None	
Video	EGA/VGA	
Halt On	All, But keyboard	
Base Memory	640K	
Extended Memory	129024K	
Total Memory	130048K	

At the bottom of the menu are the control keys for use on this menu. If you need any help in each item field, you can press the <F1> key. It will display the relevant information to help you. The memory display at the lower right-hand side of the menu is read-only. It will adjust automatically according to the memory changed. The following describes each item of this menu.

Date

The date format is:

Day : Sun to Sat
Month : 1 to 12
Date : 1 to 31
Year : 1999 to 2099

To set the date, highlight the “Date” field and use the PageUp/ PageDown or +/- keys to set the current time.

Time

The time format is: **Hour : 00 to 23**
Minute : 00 to 59
Second : 00 to 59

To set the time, highlight the "Time" field and use the <PgUp>/<PgDn> or +/- keys to set the current time.

IDE Primary HDDs / IDE Secondary HDDs

The onboard PCI IDE connectors provide Primary and Secondary channels for connecting up to four IDE hard disks or other IDE devices. Each channel can support up to two hard disks; the first is the "Master" and the second is the "Slave".

Press <Enter> to configure the hard disk. The selections include Auto, Manual, and None. Select 'Manual' to define the drive information manually. You will be asked to enter the following items.

CYLS : Number of cylinders
HEAD : Number of read/write heads
PRECOMP : Write precompensation
LANDING ZONE : Landing zone
SECTOR : Number of sectors

The Access Mode selections are as follows:

CHS (HD < 528MB)
LBA (HD > 528MB and supports
 Logical Block Addressing)
Large (for MS-DOS only)
Auto

Remarks: The main board supports two serial ATA ports and are represented in this setting as IDE Channel 2 / 3 Master.

Drive A / Drive B

These fields identify the types of floppy disk drive A or drive B that has been installed in the computer. The available specifications are:

360KB 1.2MB 720KB 1.44MB 2.88MB
5.25 in. 5.25 in. 3.5 in. 3.5 in. 3.5 in.

Video

This field selects the type of video display card installed in your system.

You can choose the following video display cards:

EGA/VGA	For EGA, VGA, SEGA, SVGA or PGA monitor adapters. (default)
CGA 40	Power up in 40 column mode.
CGA 80	Power up in 80 column mode.
MONO	For Hercules or MDA adapters.

Halt On

This field determines whether or not the system will halt if an error is detected during power up.

No errors	The system boot will not be halted for any error that may be detected.
All errors	Whenever the BIOS detects a non-fatal error, the system will stop and you will be prompted.
All, But Keyboard	The system boot will not be halted for a keyboard error; it will stop for all other errors
All, But Diskette	The system boot will not be halted for a disk error; it will stop for all other errors.
All, But Disk/Key	The system boot will not be halted for a keyboard or disk error; it will stop for all others.

Advanced BIOS Features

This section allows you to configure and improve your system and allows you to set up some system features according to your preference.

Phoenix - AwardBIOS CMOS Setup Utility
Advanced BIOS Features

CPU Feature	Press Enter	ITEM HELP
Virus Warning	Disabled	Menu Level >
CPU L1 and L2 Cache	Enabled	
Quick Power On Self Test	Enabled	
First Boot Device	Floppy	
Second Boot Device	HDD-0	
Third Boot Device	CDROM	
Boot Other Device	Enabled	
Swap Floppy Drive	Disabled	
Boot Up Floppy Seek	Enabled	
Boot Up NumLock Status	On	
Gate A20 Option	Fast	
Typematic Rate Setting	Disabled	
Typematic Rate (Chars/Sec)	6	
Typematic Delay (Msec)	250	
Security Option	Setup	
APIC Mode	Enabled	
MPS Version Control for OS	1.4	
OS Select For DRAM>64MB	Non-OS2	
Report No FDD For WIN 95	No	
Small Logo (EPA) Show	Disabled	

CPU Feature

Press Enter to configure the settings relevant to CPU Feature.

Virus Warning

If this option is enabled, an alarm message will be displayed when trying to write on the boot sector or on the partition table on the disk, which is typical of the virus.

CPU L1 and L2 Cache

Cache memory is additional memory that is much faster than conventional DRAM (system memory). CPUs from 486-type on up contain internal cache memory, and most, but not all, modern PCs have additional (external) cache memory. When the CPU requests data, the system transfers the requested data from the main DRAM into cache memory, for even faster access by the CPU. These items allow you to enable (speed up memory access) or disable the cache function. By default, these items are Enabled.

Quick Power On Self Test

When enabled, this field speeds up the Power On Self Test (POST) after the system is turned on. If it is set to *Enabled*, BIOS will skip some items.

First/Second/Third Boot Device

These fields determine the drive that the system searches first for an operating system. The options available include *Floppy*, *LS120*, *HDD-0*, *SCSI*, *CDROM*, *HDD-1*, *HDD-2*, *HDD-3*, *ZIP100*, *USB-FDD*, *USB-CDROM*, *USB-HDD* and *Disable*.

Boot Other Device

These fields allow the system to search for an OS from other devices other than the ones selected in the First/Second/Third Boot Device.

Swap Floppy Drive

This item allows you to determine whether or not to enable Swap Floppy Drive. When enabled, the BIOS swaps floppy drive assignments so that Drive A becomes Drive B, and Drive B becomes Drive A. By default, this field is set to *Disabled*.

Boot Up Floppy Seek

This feature controls whether the BIOS checks for a floppy drive while booting up. If it cannot detect one (either due to improper configuration or its absence), it will flash an error message.

Boot Up NumLock Status

This allows you to activate the NumLock function after you power up the system.

Gate A20 Option

This field allows you to select how Gate A20 is worked. Gate A20 is a device used to address memory above 1 MB.

Typematic Rate Setting

When disabled, continually holding down a key on your keyboard will generate only one instance. When enabled, you can set the two typematic controls listed next. By default, this field is set to *Disabled*.

Typematic Rate (Chars/Sec)

When the typematic rate is enabled, the system registers repeated keystrokes speeds. Settings are from 6 to 30 characters per second.

Typematic Delay (Msec)

When the typematic rate is enabled, this item allows you to set the time interval for displaying the first and second characters. By default, this item is set to *250msec*.

Security Option

This field allows you to limit access to the System and Setup. The default value is *Setup*. When you select *System*, the system prompts for the User Password every time you boot up. When you select *Setup*, the system always boots up and prompts for the Supervisor Password only when the Setup utility is called up.

APIC Mode

APIC stands for Advanced Programmable Interrupt Controller. The default setting is *Enabled*.

MPS Version Control for OS

This option is specifies the MPS (Multiprocessor Specification) version for your operating system. MPS version 1.4 added extended configuration tables to improve support for multiple PCI bus configurations and improve future expandability. The default setting is *1.4*.

OS Select for DRAM > 64MB

This option allows the system to access greater than 64MB of DRAM memory when used with OS/2 that depends on certain BIOS calls to access memory. The default setting is *Non-OS/2*.

Report No FDD For WIN 95

If you are using Windows 95/98 without a floppy disk drive, select Enabled to release IRQ6. This is required to pass Windows 95/98's SCT test. You should also disable the Onboard FDC Controller in the Integrated Peripherals screen when there's no floppy drive in the system. If you set this feature to Disabled, the BIOS will not report the missing floppy drive to Win95/98.

Small Logo (EPA) Show

The EPA logo appears at the right side of the monitor screen when the system is boot up.

Advanced Chipset Features

This Setup menu controls the configuration of the chipset.

Phoenix - AwardBIOS CMOS Setup Utility
Advanced Chipset Features

		ITEM HELP
DRAM Timing Selectable	By SPD	Menu Level >
CAS Latency Time	2.5	
Active to Precharge Delay	6	
DRAM RAS# to CAS# Delay	3	
DRAM RAS# Precharge	3	
DRAM Data Integrity Mode	Non-ECC	
MGM Core Frequency	Auto Max 266MHz	
System BIOS Cacheable	Enabled	
Video BIOS Cacheable	Disabled	
Memory Hole at 15M-16M	Disabled	
Delayed Transaction	Enabled	
Delay Prior to Thermal	16 Min	
AGP Aperture Size (MB)	64	
** On-Chip VGA Setting **		
On-Chip VGA	Enabled	
On-Chip Frame Buffer Size	32MB	
Boot Display	CRT+LVDS	
Panel Scaling	Auto	
Panel Number	1024x768 18bit SC	
Integrated LAN	Enabled	

DRAM Timing Selectable

This option refers to the method by which the DRAM timing is selected. The default is **By SPD**.

CAS Latency Time

You can configure CAS latency time in HCLKs as 2 or 2.5 or 3. The system board designer should set the values in this field, depending on the DRAM installed. Do not change the values in this field unless you change specifications of the installed DRAM or the installed CPU.

Active to Precharge Delay

The default setting for the Active to Precharge Delay is 7.

DRAM RAS# to CAS# Delay

This option allows you to insert a delay between the RAS (Row Address Strobe) and CAS (Column Address Strobe) signals. This delay occurs when the SDRAM is written to, read from or refreshed. Reducing the delay improves the performance of the SDRAM.

DRAM RAS# Precharge

This option sets the number of cycles required for the RAS to accumulate its charge before the SDRAM refreshes. The default setting for the Active to Precharge Delay is 3.

DRAM Data Integrity Mode

Select ECC if your memory module supports it. The memory controller will detect and correct single-bit soft memory errors. The memory controller will also be able to detect double-bit errors though it will not be able to correct them. This provides increased data integrity and system stability.

MGM Core Frequency

This field sets the frequency of the DRAM memory installed. The default setting is *Auto Max 266MHz*.

System BIOS Cacheable

The setting of *Enabled* allows caching of the system BIOS ROM at F000h-FFFFh, resulting in better system performance. However, if any program writes to this memory area, a system error may result.

Video BIOS Cacheable

The Setting *Enabled* allows caching of the video BIOS ROM at C0000h-F7FFFh, resulting in better video performance. However, if any program writes to this memory area, a system error may result.

Memory Hole At 15M-16M

In order to improve performance, certain space in memory can be reserved for ISA cards. This memory must be mapped into the memory space below 16 MB. The choices are *Enabled* and *Disabled*.

Delayed Transaction

The chipset has an embedded 32-bit posted write buffer to support delay transactions cycles. Select *Enabled* to support compliance with PCI specification version 2.1.

Delay Prior to Thermal

This field activates the CPU thermal function after the systems boots for the set number of minutes. The options are *16Min* and *64Min*.

AGP Aperture Size

The field sets aperture size of the graphics. The aperture is a portion of the PCI memory address range dedicated for graphics memory address space. Host cycles that hit the aperture range are forwarded to the AGP without any translation. The default setting is **64M**.

On-Chip VGA

The default setting is **Enabled**.

On-Chip Frame Buffer Size

The default setting is **32MB**. The options available include **1MB**, **4MB**, **8MB** and **16MB**.

Boot Display

The default setting is **CRT+LVDS**. The other options are **CRT** and **LVDS**.

Panel Scaling

The default setting is **Auto**. The options available include **On** and **Off**.

Panel Number

These fields allow you to select the LCD Panel type. The default values for these ports are:

640x480	18bit SC
800x600	18bit SC
1024x768	18bit SC
1280x1024	24bit DC
1400x1050	18bit DC
1024x768	24bit SC
1600x1200	18bit DC
1280x768	24bit DC
1366x768	24bit DC
1280x768	24bit DC
1400x900	18bit DC

Integrated LAN

This field allows you to enable or disable the integrated LAN controller.

Integrated Peripherals

This section sets configurations for your hard disk and other integrated peripherals. The first screen shows three main items for user to select. Once an item selected, a submenu appears. Details follow.

Phoenix - AwardBIOS CMOS Setup Utility
Integrated Peripherals

OnChip IDE Device	Press Enter	ITEM HELP
Onboard Device	Press Enter	Menu Level >
SuperIO Device	Press Enter	

Phoenix - AwardBIOS CMOS Setup Utility
OnChip IDE Device

On-Chip Primary PCI IDE	Enabled	ITEM HELP
IDE Primary Master PIO	Auto	Menu Level >
IDE Primary Slave PIO	Auto	
IDE Primary Master UDMA	Auto	
IDE Primary Slave UDMA	Auto	
On-Chip Secondary PCI IDE	Enabled	
IDE Secondary Master PIO	Auto	
IDE Secondary Slave PIO	Auto	
IDE Secondary Master UDMA	Auto	
IDE Secondary Slave UDMA	Auto	
IDE HDD Block Mode	Enabled	

Phoenix - AwardBIOS CMOS Setup Utility
Onboard Device

USB Controller	Enabled	ITEM HELP
USB 2.0 Controller	Enabled	Menu Level >
USB Keyboard Support	Disabled	
USB Mouse Support	Disabled	
AC97 Audio	Auto	
Init Display First	PCI Slot	

Phoenix - AwardBIOS CMOS Setup Utility
SuperIO Device

		ITEM HELP
Onboard FDC Controller	Enabled	Menu Level >
Onboard Serial Port 1	3F8/IRQ4	
Onboard Serial Port 2	2F8/IRQ3	
UART Mode Select	Normal	
RxD , TxD Active	Hi, Lo	
IR Transmission Delay	Enabled	
UR2 Duplex Mode	Half	
Use IR Pins	IR-Rx2Tx2	
Onboard Parallel Port	378/IRQ7	
Parallel Port Mode	SPP	
EPP Mode Select	EPP1.7	
ECP Mode Use DMA	3	
PWRON After PWR-Fail	Off	

OnChip Primary/Secondary PCI IDE

The integrated peripheral controller contains an IDE interface with support for two IDE channels. Select *Enabled* to activate each channel separately.

IDE Primary/Secondary Master/Slave PIO

These fields allow your system hard disk controller to work faster. Rather than have the BIOS issue a series of commands that transfer to or from the disk drive, PIO (Programmed Input/Output) allows the BIOS to communicate with the controller and CPU directly.

The system supports five modes, numbered from 0 (default) to 4, which primarily differ in timing. When Auto is selected, the BIOS will select the best available mode.

IDE Primary/Secondary Master/Slave UDMA

These fields allow your system to improve disk I/O throughput to 33Mb/sec with the Ultra DMA/33 feature. The options are *Auto* and *Disabled*.

IDE HDD Block Mode

This field allows your hard disk controller to use the fast block mode to transfer data to and from your hard disk drive.

USB Controller

The options for this field are *Enabled* and *Disabled*. By default, this field is set to *Enabled*.

USB 2.0 Controller

The options for this field are *Enabled* and *Disabled*. By default, this field is set to *Enabled*. In order to use USB 2.0, necessary OS drivers must be installed first. *Please update your system to Windows 2000 SP4 or Windows XP SP1.*

USB Keyboard Support

The options for this field are *Enabled* and *Disabled*. By default, this field is set to *Disabled*.

USB Mouse Support

The options for this field are *Enabled* and *Disabled*. By default, this field is set to *Disabled*.

AC97 Audio

The default setting of the AC97 Audio is *Auto*.

Init Display First

The default setting is *PCI Slot*.

Onboard FDC Controller

Select *Enabled* if your system has a floppy disk controller (FDC) installed on the motherboard and you wish to use it. If you install an add-in FDC or the system has no floppy drive, select *Disabled* in this field. This option allows you to select the onboard FDD port.

Onboard Serial/Parallel Port

These fields allow you to select the onboard serial and parallel ports and their addresses. The default values for these ports are:

Serial Port 1	3F8/IRQ4
Serial Port 2	2F8/IRQ3
Parallel Port	378H/IRQ7

UART Mode Select

This field determines the UART 2 mode in your computer. The default value is *Normal*. Other options include *IrDA* and *ASKIR*.

Parallel Port Mode

This field allows you to determine parallel port mode function.

SPP	Standard Printer Port
EPP	Enhanced Parallel Port
ECP	Extended Capabilities Port

Power On After Fail

The setting configures the system power on status when power is restored to the system after a power failure occurrence. The default setting is *Off*.

Power Management Setup

The Power Management Setup allows you to save energy of your system effectively.

Phoenix - AwardBIOS CMOS Setup Utility
Power Management Setup

		ITEM HELP
Power-Supply Type	ATX	
ACPI Function	Enabled	
Power Management	User Define	Menu Level >
Video Off Method	V/H SYNC+Blank	
Video Off In Suspend	Yes	
Suspend Type	Stop Grant	
Modem Use IRQ	3	
Suspend Mode	Disabled	
HDD Power Down	Disabled	
Soft-Off by PWR-BTTN	Instant-Off	
CPU THRM-Throttling	50%	
Resume by Alarm	Disabled	
Date (of Month) Alarm	0	
Time (hh:mm:ss) Alarm	0 : 0 : 0	
** Reload Global Timer Events **		
Primary IDE 0	Disabled	
Primary IDE 1	Disabled	
Secondary IDE 0	Disabled	
Secondary IDE 1	Disabled	
FDD, COM, LPT Port	Disabled	
PCI PIRQ[A-D] #	Disabled	

Power Supply Type

Use this field to select the power supply type used in the system. The default setting is *ATX*.

ACPI Function

Enable this function to support ACPI (Advance Configuration and Power Interface).

Power Management

This field allows you to select the type of power saving management modes. There are four selections for Power Management.

Min. Power Saving	Minimum power management
Max. Power Saving	Maximum power management.
User Define	Each of the ranges is from 1 min. to 1hr. Except for HDD Power Down which ranges from 1 min. to 15 min.

Video Off Method

This field defines the Video Off features. There are three options.

V/H SYNC + Blank	Default setting, blank the screen and turn off vertical and horizontal scanning.
DPMS	Allows BIOS to control the video display.
Blank Screen	Writes blanks to the video buffer.

Video Off In Suspend

When enabled, the video is off in suspend mode. The default setting is *Yes*.

Suspend Type

The default setting for the Suspend Type field is *Stop Grant*.

Modem Use IRQ

This field sets the IRQ used by the Modem. By default, the setting is 3.

Suspend Mode

When enabled, and after the set time of system inactivity, all devices except the CPU will be shut off.

HDD Power Down

When enabled, and after the set time of system inactivity, the hard disk drive will be powered down while all other devices remain active.

Soft-Off by PWRBTN

This field defines the power-off mode when using an ATX power supply. The *Instant Off* mode allows powering off immediately upon pressing the power button. In the *Delay 4 Sec* mode, the system powers off when the power button is pressed for more than four seconds or enters the suspend mode when pressed for less than 4 seconds.

CPU THRM-Throttling

When the system enters Doze mode, the CPU clock runs only part of the time. You may select the percent of time that the clock runs.

Resume by Alarm

This field enables or disables the resumption of the system operation. When enabled, the user is allowed to set the *Date* and *Time*.

Reload Global Timer Events

The HDD, FDD, COM, LPT Ports, and PCI PIRQ are I/O events that can prevent the system from entering a power saving mode or can awaken the system from such a mode. When an I/O device wants to gain the attention of the operating system, it signals this by causing an IRQ to occur. When the operating system is ready to respond to the request, it interrupts itself and performs the service.

PNP/PCI Configurations

This option configures the PCI bus system. All PCI bus systems on the system use INT#, thus all installed PCI cards must be set to this value.

Phoenix - AwardBIOS CMOS Setup Utility
PnP/PCI Configurations

Reset Configuration Data	Disabled	ITEM HELP
Resources Controlled By	Auto (ESCD)	Menu Level
IRQ Resources	Press Enter	Default is Disabled. Select Enabled to reset Extended System Configuration Data (ESCD) when you exit Setup if you have installed a new add-on and the system reconfiguration has caused such a serious conflict that the OS cannot boot.
PCI/VGA Palette Snoop	Disabled	

Reset Configuration Data

This field allows you to determine whether to reset the configuration data or not. The default value is *Disabled*.

Resources Controlled by

This PnP BIOS can configure all of the boot and compatible devices automatically with the use of a use a PnP operating system such as Windows 95.

PCI/VGA Palette Snoop

Some non-standard VGA display cards may not show colors properly. This field allows you to set whether or not MPEG ISA/VESA VGA cards can work with PCI/VGA. When this field is enabled, a PCI/VGA can work with an MPEG ISA/VESA VGA card. When this field is disabled, a PCI/VGA cannot work with an MPEG ISA/VESA card.

PC Health Status

This section shows the parameters in determining the PC Health Status. These parameters include temperatures, fan speeds and voltages.

Phoenix - AwardBIOS CMOS Setup Utility
PC Health Status

		ITEM HELP
CPU Warning Temperature	Disabled	Menu Level >
System Temp.	45°C/113°F	
CPU Temp	52°C/125°F	
Vcore(V)	1.18 V	
Vtt(V)	1.37V	
Vcc3(V)	3.39V	
+5V	5.13 V	
VBAT	3.21 V	
5VSB(V)	4.96 V	
Shutdown Temperature	Disabled	

CPU Warning Temperature

This field allows the user to set the temperature so that when the temperature is reached, the system sounds a warning. This function can help prevent damage to the system that is caused by overheating.

Temperatures/Voltages

These fields are the parameters of the hardware monitoring function feature of the motherboard. The values are read-only values as monitored by the system and show the PC health status.

Shutdown Temperature

This field allows the user to set the temperature by which the system automatically shuts down once the threshold temperature is reached. This function can help prevent damage to the system that is caused by overheating.

Frequency/Voltage Control

This section shows the user how to configure the processor frequency.

Phoenix - AwardBIOS CMOS Setup Utility
Frequency/Voltage Control

Auto Detect PCI Clk	Disabled	ITEM HELP
Spread Spectrum Modulated	Disabled	Menu Level >

Auto Detect PCI Clk

This field enables or disables the auto detection of the PCI clock.

Spread Spectrum Modulated

This field sets the value of the spread spectrum. The default setting is *Disabled*. This field is for CE testing use only.

Load Fail-Safe Defaults

This option allows you to load the troubleshooting default values permanently stored in the BIOS ROM. These default settings are non-optimal and disable all high-performance features.

Load Optimized Defaults

This option allows you to load the default values to your system configuration. These default settings are optimal and enable all high performance features.

Set Supervisor Password

These two options set the system password. Supervisor Password sets a password that will be used to protect the system and Setup utility. User Password sets a password that will be used exclusively on the system. To specify a password, highlight the type you want and press <Enter>. The Enter Password: message prompts on the screen. Type the password, up to eight characters in length, and press <Enter>. The system confirms your password by asking you to type it again. After setting a password, the screen automatically returns to the main screen.

To disable a password, just press the <Enter> key when you are prompted to enter the password. A message will confirm the password to be disabled. Once the password is disabled, the system will boot and you can enter Setup freely.

Save & Exit Setup

This option allows you to determine whether or not to accept the modifications. If you type “Y”, you will quit the setup utility and save all changes into the CMOS memory. If you type “N”, you will return to Setup utility.

Exit Without Saving

Select this option to exit the Setup utility without saving the changes you have made in this session. Typing “Y” will quit the Setup utility without saving the modifications. Typing “N” will return you to Setup utility.

This page is intentionally left blank.

Drivers Installation

This section describes the installation procedures for software and drivers under the Windows 98SE, Windows ME, Windows 2000 and Windows XP. The software and drivers are included with the motherboard. If you find the items missing, please contact the vendor where you made the purchase. The contents of this section include the following:

Intel Chipset Software Intallation Utility	46
VGA Drivers Installation	48
AC97 Codec Audio Driver Installation.....	49
Intel PRO LAN Drivers Installation.....	50

IMPORTANT NOTE:

After installing your Windows operating system (Windows 98SE/ME/2000/XP), you must install first the Intel Chipset Software Installation Utility before proceeding with the drivers installation.

Intel Chipset Software Intallation Utility

The Intel Chipset Drivers should be installed first before the software drivers to enable Plug & Play INF support for Intel chipset components. Follow the instructions below to complete the installation under Windows 98SE/ME/2000/XP.

1. Insert the CD that comes with the board. Click *Intel Chipsets* and then *Intel(R) 855GME Chipset Drivers*.

2. Click *Intel(R) Chipset Software Installation Utility*.



3. When the Welcome screen appears, click *Next* to continue.

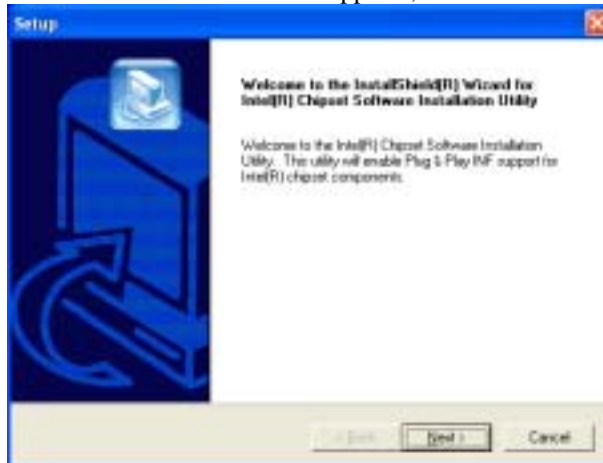

4. Click **Yes** to accept the software license agreement and proceed with the installation process.

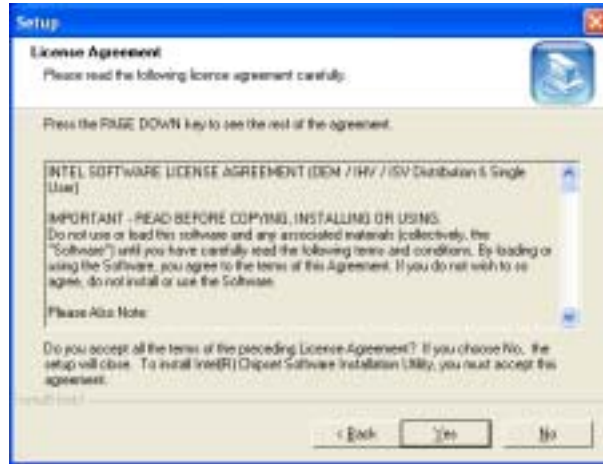

5. On Readme Information screen, click **Next** to continue the installation.

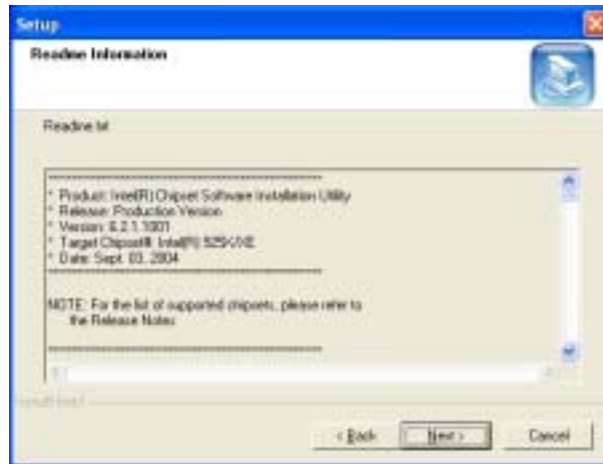

6. The Setup process is now complete. Click **Finish** to restart the computer and for changes to take effect. When the computer has restarted, the system will be able to find some devices. Restart your computer when prompted.

VGA Drivers Installation

To install the VGA drivers, follow the steps below to proceed with the installation.

1. Insert the CD that comes with the motherboard. Click *Intel Chipsets* and then *Intel(R) 855GME Chipset Drivers*.
2. Click *Intel(R) 855/852GME Chipset Family Graphics Driver*.

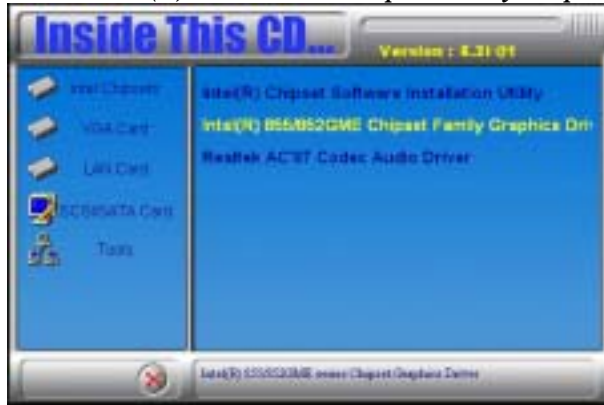

3. When the Welcome screen appears, click *Next* to continue.
4. Click *Yes* to agree with the license agreement and continue the installation.
5. Restart the computer as prompted and for changes to take effect.

AC97 Codec Audio Driver Installation

Follow the steps below to install the Realtek AC97 Codec Audio Drivers.

1. Insert the CD that comes with the motherboard. Click **Intel Chipsets** and then **Intel(R) 855/852GME Chipset Drivers**.
2. Click **Realtek AC'97 Codec Audio Drive** to start the installation.



3. Click **Finish** to restart the computer and for changes to take effect. .

Intel PRO LAN Drivers Installation

Follow the steps below to complete the installation of the Intel PRO LAN drivers.

1. Insert the CD that comes with the motherboard. Click *LAN Card* and then *Intel(R) PRO LAN Drivers*.



2. Click *Install Base Software* to continue.



3. When prompted, please to restart the computer for new settings to take effect.

Appendix

A. I/O Port Address Map

Each peripheral device in the system is assigned a set of I/O port addresses which also becomes the identity of the device. The following table lists the I/O port addresses used.

Address	Device Description
000h - 01Fh	DMA Controller #1
020h - 03Fh	Interrupt Controller #1
040h - 05Fh	Timer
060h	Keyboard Controller (1)
0601h	Control Port
064h	Real Time Clock
070h - 07Fh	Keyboard Controller (2)
080h - 09Fh	DMA Page Register
0A0h - 0BFh	Interrupt Controller #2
0C0h - 0DFh	DMA Controller #2
0F0h - 00FFh	Coprocessor
0170h - 0177h 0376h	IDE (Secondary)
01F0h - 01F7h 03F6h	IDE (Primary)
02F8h - 02FFh	Serial Port #2(COM2)
0378h - 037Ah	Parallel Port #1(LPT1)
03C0h - 03DFh	Reserved for VGA
03F0h - 03F5h 03F7h	FDD Controller
03F8h - 3FFh	Serial Port #1(COM1)
Xxxxh - xxxxh	Ethernet Controller

B. Interrupt Request Lines (IRQ)

Peripheral devices use interrupt request lines to notify CPU for the service required. The following table shows the IRQ used by the devices on board.

Level	Function
IRQ0	System Timer Output
IRQ1	Keyboard
IRQ2	PIC2 (IRQ8-15)
IRQ3	Serial Port #2
IRQ4	Serial Port #1
IRQ5	For PCI
IRQ6	Floppy Disk Controller
IRQ7	Parallel Port #1
IRQ8	Real Time Clock
IRQ9	For PCI
IRQ10	For PCI
IRQ11	For PCI
IRQ12	PS/2 Mouse
IRQ13	Coprocessor
IRQ14	Primary IDE
IRQ15	Secondary IDE

C. Watchdog Timer Configuration

The WDT is used to generate a variety of output signals after a user programmable count. The WDT is suitable for use in the prevention of system lock-up, such as when software becomes trapped in a deadlock. Under these sort of circumstances, the timer will count to zero and the selected outputs will be driven. Under normal circumstance, the user will restart the WDT at regular intervals before the timer counts to zero.

SAMPLE CODE:

This code and information is provided "as is" without warranty of any kind, either expressed or implied, including but not limited to the implied warranties of merchantability and/or fitness for a particular purpose.

```

;[]=====
; Name   : Enable_And_Set_Watchdog
; IN    : AL - 1sec ~ 255sec
; OUT   : None
;[]=====
Enable_And_Set_Watchdog Proc Near
    push ax                ;save time interval
    call Unlock_Chip

    mov cl, 2Bh
    call Read_Reg
    and al, NOT 10h
    call Write_Reg        ;set GP24 as WDTO

    mov cl, 07h
    mov al, 08h
    call Write_Reg        ;switch to LD8
    mov cl, 0F5h
    call Read_Reg
    and al, NOT 08h
    call Write_Reg        ;set count mode as second

    pop ax
    mov cl, 0F6h
    call Write_Reg        ;set watchdog timer

    mov al, 01h
    mov cl, 30h
    call Write_Reg        ;watchdog enabled

```

```
        call Lock_Chip
        ret
Enable_And_Set_Watchdog Endp

;[=====
;Name   : Disable_Watchdog
;IN    : None
;OUT   : None
;[=====
Disable_Watchdog Proc Near
        call Unlock_Chip

        mov cl, 07h
        mov al, 08h
        call Write_Reg    ;switch to LD8

        xor al, al
        mov cl, 0F6h
        call Write_Reg    ;clear watchdog timer

        xor al, al
        mov cl, 30h
        call Write_Reg    ;watchdog disabled

        call Lock_Chip
        ret
Disable_Watchdog Endp

;[=====
;Name   : Unlock_Chip
;IN    : None
;OUT   : None
;[=====
Unlock_Chip Proc Near
        mov dx, 4Eh
        mov al, 87h
        out dx, al
        out dx, al
        ret
Unlock_Chip Endp

;[=====
;Name   : Lock_Chip
;IN    : None
;OUT   : None
```

```
=====  
:[]=====  
Unlock_Chip Proc Near  
    mov dx, 4Eh  
    mov al, 0Aah  
  
    out dx, al  
    ret  
Unlock_Chip Endp  
:[]=====  
; Name      : Write_Reg  
; IN       : CL - register index  
; AL       : Value to write  
; OUT      : None  
:[]=====  
Write_Reg Proc Near  
    push ax  
    mov dx, 4Eh  
    mov al, cl  
    out dx, al  
    pop ax  
    inc dx  
    out dx, al  
    ret  
Write_Reg Endp  
:[]=====  
; Name      : Read_Reg  
; IN       : CL - register index  
; OUT      : AL - Value to read  
:[]=====  
Read_Reg Proc Near  
    mov al, cl  
    mov dx, 4Eh  
    out dx, al  
    inc dx  
    in  al, dx  
    ret  
Read_Reg Endp  
:[]=====
```

D. IB881 CMOS Backup Feature

IB881 can backup CMOS data that has been changed and saved last time.

The CMOS data will be reloaded from EEPROM when CMOS is lost, such as in the case of battery failure.

If you would like to load original Optimized Defaults to test, for any reason, please follow the instructions below.

1. Turn off IB881.
2. Clear CMOS by changing jumper location from 1-2 to 2-3 of JP2.
3. Return jumper to location 1-2 of JP2.
4. Keep pressing Insert key then turn on IB881.
IB881 stops at first boot screen and shows CMOS checksum error – Defaults loaded message.
5. Press DEL key to enter BIOS Setup screen and modify settings.
6. Press F10 function key then Enter key to save settings and exit.
CMOS data will be backup to EEPROM also.